

Submitted to:

Cathryn Hooper
The Crown Estates Office
16 Carlton House Terrace
London
SW1Y 5AH

Tel: +44 (0)20 7210 4377
Fax: +44 (0)20 7839 7847

email: cathryn.hooper@crownestate.co.uk

Submitted by:

Jeremy Nedwell
Subacoustech Ltd
Chase Mill
Winchester Road
Bishops Waltham
Southampton
Hants SO32 1AH

Tel: +44 (0)1489 891849
Fax: +44 (0)8700 513060

email: subacoustech@subacoustech.com
website: www.subacoustech.com

Measurements of underwater noise during construction of offshore windfarms, and comparison with background noise.

Report No. 544 R 0411

by

Dr J. Nedwell, Mr J. Langworthy & Mr D. Howell

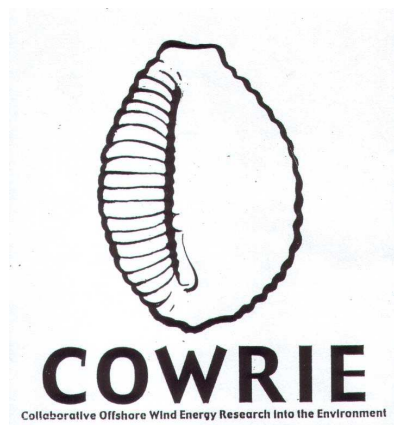

This report has been commissioned by COWRIE

Approved for release:

A handwritten signature in black ink, which appears to be "J. Nedwell", is written over a circular stamp or mark.

The reader should note that this report is a controlled document. Appendix E lists the version number, record of changes, referencing information, abstract and other documentation details.

Contents

EXECUTIVE SUMMARY	4
1 INTRODUCTION.....	5
2 PRINCIPLES UNDERLYING THE MEASUREMENTS TAKEN.....	6
2.1 THE EFFECTS OF UNDERWATER NOISE.....	6
2.2 SHOALS: TYPICAL WINDFARM LOCATIONS.	6
2.3 THE NEED FOR MEAN AND STATISTICAL DESCRIPTIONS OF NOISE.	7
2.4 AREAS OF IGNORANCE.....	7
2.5 POSSIBLE MEASUREMENT STRATEGIES.	8
2.5.1 <i>Fixed position monitoring</i>	8
2.5.2 <i>Assessing spatial and temporal variability: transects</i>	9
3 THE MEASUREMENTS.....	10
3.1 INSTRUMENTATION AND MEASUREMENT PROCEDURE.....	10
3.2 FACTORS LIMITING THE MEASUREMENTS.....	10
3.3 DESCRIPTION OF THE TYPES OF NOISE MEASURED	10
3.4 THE TRANSECTS USED FOR MEASUREMENTS.	11
3.4.1 <i>North Hoyle</i>	11
3.4.2 <i>Blyth</i>	11
3.4.3 <i>Scroby Sands</i>	12
3.5 INSTRUMENTATION AND MEASUREMENT PROCEDURE.....	12
3.6 THE PROCESSING OF MEASUREMENTS.....	13
3.6.1 <i>General processing</i>	13
3.6.2 <i>Perception units; the dB_{ht} (species)</i>	14
3.6.3 <i>Processing environment and quality checks</i>	15
4 BACKGROUND NOISE MEASUREMENTS.....	17
4.1 BACKGROUND NOISE IN CONVENTIONAL UNITS.....	17
4.2 BACKGROUND NOISE IN dB _{HT} UNITS	19
4.3 NORTH HOYLE – NOISE FROM THE DOUGLAS PLATFORM.....	20
5 CONSTRUCTION NOISE MEASUREMENTS.....	22
5.1 PILING AT NORTH HOYLE.....	22
5.1.1 <i>Measurements of piling at North Hoyle, conventional units</i>	22
5.1.2 <i>Measurements of piling at North Hoyle, dB_{ht} units</i>	24
5.1.3 <i>Measurements of piling at North Hoyle; possible physical effects of piling noise on fish</i>	25
5.2 IMPACT PILE DRIVING AT SCROBY SANDS	26
5.3 CABLE TRENCHING AT NORTH HOYLE	27
5.4 ROCK SOCKET DRILLING NOISE AT NORTH HOYLE.....	28
6 MITIGATION MEASURES FOR PILING.....	29
6.1 HOW PILING CREATES NOISE	29
6.2 QUANTIFICATION OF LIKELY EFFECTS.....	29
6.3 MITIGATION MEASURES.....	30
6.3.1 <i>Control at source</i>	30
6.3.2 <i>Non engineering methods</i>	31
6.3.3 <i>Monitoring</i>	31
7 SUMMARY AND CONCLUSIONS.....	33
8 FIGURES.....	34
9 REFERENCES.....	59
10 APPENDIX A - MEASURING NOISE.....	60
11 APPENDIX B - DETAILS OF INSTRUMENTATION AND MEASUREMENT TECHNIQUES.....	66

12	APPENDIX C - DESCRIPTION OF WINDFARM RELATED NOISE SOURCES.	69
13	APPENDIX D - CALIBRATION CHARTS.....	70
14	APPENDIX E - RECORD OF CHANGES.....	73

Executive summary

Concern has been expressed over the possible effects of man made underwater noise caused by windfarms. This has been cited as having the capacity at high levels to cause death, physical injury (such as deafness) and behaviour changes in marine mammals and fish. Since the impacts caused by waterborne noise are not yet fully understood, Subacoustech Ltd have been contracted by The Crown Estate on behalf of Collaborative for Offshore Wind Research Into the Environment (COWRIE) to measure and interpret the underwater noise generated by offshore windfarms and their construction. The purposes of the measurements are to evaluate the pre-existing background noise environment, to rate noise from construction and operation of windfarms in terms of its potential for environmental effect, and to provide information which will aid estimation and minimisation of the impact of noise during the lifecycle (construction, operation and decommissioning) of windfarms.

The report presents a significant body of underwater noise measurements taken in the period 4/2003 to 1/2004 at operational and construction stage windfarm sites in the UK. A detailed analysis of the measurements has been made which indicates the spatial, temporal and statistical properties of the noise. An estimation of the likely behavioural and physical effects on a selection of the most common species of fish and marine mammals is also presented using both conventional analysis and the dB_{ht} (*species*) scale.

The measurements of ambient noise in shoals indicates that in general, the levels are towards the upper bound of typical deep water ambient noise levels. The overall sound pressure level varies significantly more during the daytime than at other times of day, due to the higher number of short local ship movements. The noise levels are higher at low wind speeds, contrary to the normal assumption that they will rise with increasing wind speed.

Measurements of background noise at North Hoyle indicated that the Douglas Platform is probably a significant pre-existing contributor to the background noise level. Its Source Level may be estimated to be about 206 dB re 1 μ Pa @ 1 metre. Measurements of piling indicated a Source Level of 260 dB re 1 μ Pa @ 1 metre for 5 metres depth, and 262 dB re 1 μ Pa @ 1 metre at 10 metres depth, associated with a Transmission Loss given by $22 \log(R)$ where R is the range. Calculations using the dB_{ht} scale levels indicate that strong avoidance reaction by a range of species would be likely at the ranges of up to several kilometres. The levels of sound recorded during piling are such that within perhaps a hundred metres they could cause injury. Measurements of cable trenching at North Hoyle indicate a Source Level of 178 dB re 1 μ Pa @ 1 metre if a Transmission Loss of $22 \log(R)$ is assumed. Measurements of rock socket drilling were made, which showed strong fundamental component at 125Hz, and harmonics up to 1Khz, but it was not possible to establish the Source Level and Transmission Loss. Components of the drilling could however be identified at ranges of up to 7 km.

Measurements of piling at Scroby Sands were similar in level to those at North Hoyle, and similar conclusions pertain in respect of possible environmental effects.

On the basis of the measurements, piling should in particular be regarded as capable of causing significant environmental effect, and planning of piling operations should take account of the effects of its noise on sensitive species. If the environmental consequences of the piling operation are unacceptable, then use must be made of suitable mitigation measures to reduce the impact to an acceptable level.

1 Introduction.

The UK government's energy targets require 10% of energy to be generated from renewable sources by 2010. The DTI forecast that a possible one in six homes could be supplied with renewable energy by the target date, and the amount of energy produced by renewable sources is set to rise significantly in coming years. Offshore windfarms represent a key component in renewable energy strategy with two operational sites, and numerous other major developments planned for commencement.

Concern has been expressed over the possible effects of man made underwater noise caused by windfarms. Underwater man-made noise is a pollutant, which has been cited as having the capacity at high levels to cause death, physical injury (such as deafness) and behaviour changes in marine mammals and fish (Richardson (1995), Turnpenny and Nedwell (1994)). At lower levels of sound, underwater noise has been cited as having the potential to impede communication amongst groups of animals, drive them away from feeding or breeding grounds, or to deflect them from migration routes.

Since the impacts caused by waterborne noise are not yet fully understood, Subacoustech Ltd have been contracted by The Crown Estate on behalf of Collaborative for Offshore Wind Research Into the Environment (COWRIE) to measure and interpret the underwater noise generated by offshore windfarms and their construction. The purposes of the measurements are to evaluate the noise from construction and operation of windfarms and to rate it in terms of its potential for environmental effect. The interpretation will eventually provide information which will aid estimation of the impact of noise during the lifecycle (construction, operation and decommissioning) of windfarms.

This report presents the analysis and interpretation of a significant body of underwater noise measurements taken in the period 4/2003 to 1/2004. The measurements were taken at operational and construction stage windfarm sites in the UK and include noise from a wide variety of sources. A detailed analysis of the measurements has been made which indicates the spatial, temporal and statistical properties of the noise. An estimation of the likely behavioural and physical effects on a selection of the most common species of fish and marine mammals is also presented using both conventional analysis and the dB_{ht} (*species*) scale.

Draft:
Not for Public Information

2 Principles underlying the measurements taken.

2.1 The effects of underwater noise.

In order to completely characterise a noise source, it is necessary to understand the level and frequency content of the source and the spatial behaviour of the noise it creates. Man-made noise sources can usually be characterised as point sources when compared with the geological scale of the ocean, and hence they cause increased levels of noise in a relatively localised area. By comparison, background noise caused by the natural physical processes of the ocean tends to be relatively uniform. Therefore, near to a man-made noise source, it is possible that the noise will greatly exceed the level of background noise. As the distance from the source increases, the noise level will be attenuated until it reaches the level of the background noise, at which point it is reasonable to assume there is no effect of the noise.

Within this range, the noise can have an increasing effect as the source is approached and its levels increase. The effects of the noise can include:

1. **primary effects**, such as immediate or delayed lethality near to high level sources such as when using explosives underwater;
2. **secondary effects**, such as injury or deafness, which may have long-term implications for survival, and
3. **tertiary (behavioural) effects**, such as avoidance of the area, which may have significant effects where the Man-made noise source is in the vicinity of breeding grounds, migratory routes or schooling areas.

Due to the relatively small areas affected, primary and secondary injury are generally relatively unlikely, although they may be significant with sources of sound having a high level and where there is a high density of individuals. Behavioural effects occur at a much lower level, and hence tend to have effects on larger numbers of animals at much greater ranges. They are consequently probably of the greatest significance in the context of the possible effects of noise from windfarm construction and operation.

In general, the measurement strategy has therefore been chosen with behavioural effects in mind. The empirical models that have been used provide useful models of the noise levels from construction noise sources at distances of about 100 metres up to 10 km and more. No measurements have been made to date which can be used to confirm the model at closer ranges than 100 metres. Caution should therefore be used when using the models at these close ranges, for instance, when modelling injury at close ranges, and under these circumstances direct measurement of actual levels may be required.

2.2 Shoals: typical windfarm locations.

At the commencement of the project, it was noted that the typical location of windfarms is in shallow coastal areas; such areas have not received great attention from the underwater acoustics community and there is little or no information on underwater noise in the public domain directly relating to them. The locations for windfarm development will typically be located in areas of shallow water, since this makes the installation of foundations easier, quicker and hence less expensive. There may be a requirement on environmental and planning grounds to put the windfarms well offshore, in which case the typical areas that are of interest are offshore shallow water areas. Such shallow areas have an additional advantage

that shipping will avoid them, and hence the potential shipping hazard caused by windfarm location in navigation channels is avoided.

In describing these areas, the term “shallow water” is frequently used. However, this is a subjective term. For instance, references to shallow water noise in the underwater acoustics literature typically result from military interest and refer to water of the order of 200 metres deep.

The authors sought a description of the typical location of windfarms, and propose the term “shoals” to describe a typical location. Dictionary definitions include “*A shallow place in a body of water.*” and “*A sandy elevation of the bottom of a body of water, constituting a hazard to navigation; a sandbank or sandbar.*”. These appear to be good descriptions of the typical location of windfarms, and hence the generic title of “noise in shoals” has been used for a general description of the type of measurements reported on herein.

2.3 The need for mean and statistical descriptions of noise.

An important consideration in specifying the measurements concerned the statistics of the noise. In determining the zone of influence of a man made source of noise, it is of interest to know not only the mean properties of noise but also its statistical properties. For instance, it is generally considered that beyond the range at which the source falls to the level of background noise, that it can have no possible effect.

In a deterministic model, this is an exact range which does not vary, but Figure 1 illustrates a more realistic model of noise. In practice, the noise will not be at a constant level but will vary over the long or short term, depending on many physical parameters, and as illustrated there will be a spread of recorded background noise levels. The mean level of the background noise will typically be relatively constant with range from the noise source. In contrast, the level of noise from the source will decrease with range due to spreading and absorption, however there will also be a spread of levels from the source, caused by variations in source level and varying propagation conditions.

At a great enough range, even when the variation of noise is taken into account the highest level of noise from the source will always be less than the lowest level of background noise; the zone beyond this range is therefore the area of “no possible effect”. At a lesser range, the highest level of background noise is always below the lowest level of noise from the source, the zone within this range is the “zone of possible effect”. Within these zones is a grey area, where the source may or may not be above the level of the background noise.

These considerations indicate why an understanding of not only the mean levels of noise but also a measure of its statistics or variability is essential when estimating the possible environmental effects of noise.

2.4 Areas of ignorance

It is noted that noise in shoals, the typical windfarm area, have not previously been a significant subject of publications. It was therefore thought important in the initial stages of measurements to identify whether the characteristics of the underwater noise were the same as for deep water.

The two main questions that the authors sought to answer in the early stages of this project were:

1. What is the prevailing level, spectrum and variability of background noise, and is it similar to the well-documented information for background noise in deep water?
2. What noise sources are created by windfarm developments, and which of these are the dominant sources?

It was therefore necessary to define a measurement strategy that would enable a suitable quality and class of information to be obtained, in order to answer these questions.

2.5 Possible measurement strategies.

There are two possible strategies to the implementation of noise monitoring, fixed position monitoring and transects. The application and relevant merits of each are discussed below.

2.5.1 Fixed position monitoring.

In this approach, a range enclosing an area which it is deemed “acceptable to affect” is defined. This may be an area which is small compared with a local fish breeding ground, of minimal size when compared with local marine mammal migratory routes, or which can be demonstrated to be smaller than that already affected by pre-existing noise sources. The monitoring of the noise is relatively simple; the aim is to answer the question “at the range at which I am monitoring, am I causing an effect?”. The noise can be monitored on a permanent or sampled basis, and in the event of the noise exceeding a set threshold, a remedial action can be triggered. The remedial action, for instance, may be to cease construction until the reason for the high level is identified and remedied. This approach is applicable to monitoring where there are well-defined limits that have been set by regulators, or by the organisation creating the noise if it is self-regulating.

An example of this strategy may be found in Figure 2 which illustrates a typical result of fixed position monitoring, in this case from monitoring of vibropiling undertaken on behalf of the Environment Agency (Nedwell *et al*, 2003). The figure illustrates the level of the sound in dB as a function of the time of day, recorded at a range of 417 metres. The upper trace, in blue, indicates the unweighted sound level in dB re 1 μ Pa, and the lower trace the level in dB_{ht} (*Salmo salar*), i.e., as a frequency weighted level above the hearing threshold of salmon. Also marked on the figure are periods during which vibropiling was undertaken.

The monitoring indicates that there are periodic short but relatively large increases in the unweighted sound pressure levels level up to about 150 dB, associated with the passage of vessels and noise from a dredger. The dB_m (*Salmo salar*) levels are much lower than the unweighted levels; this results from salmon being relatively insensitive to sound, and to a lesser degree from their limited hearing bandwidth.

The monitoring has demonstrated that in neither case is there a discernible increase of the signal when the driving is taking place compared to when it is not. It may be noted, though, that fixed position monitoring has drawbacks in relation to understanding the spatial behaviour of the field. This measurement, for instance, has not yielded any information as to the range at which the vibropiling noise would exceed the background noise.

2.5.2 Assessing spatial and temporal variability: transects.

In principle, given the level of noise generated by a source, the rate at which the noise reduces with distance and the level at which a given effect will occur, it is possible to calculate a range from the source at which the effect will occur. However, the statistics of both the man made noise and the background noise must be assessed in order for a complete understanding of the potential effects of the noise. Background noise is affected by a range of physical quantities, such as the local water depth, substrate type, wind speed, degree of local shipping, etc. The propagation from the source is similarly affected by variations of, or inhomogeneities in, the temperature and salinity of the water, bubble content etc. Finally, the source itself may vary.

The area affected by the noise thus may vary greatly from time to time, and while the mean area affected is a valuable measure, a statistical measure, such as the area affected 5% of the time, may be equally important. Generally, a reliable measure of the statistical properties of the noise requires many repetitive measurements, allowing the spatial effects (variation with distance) and the temporal effects (variation with time) to be assessed. To achieve this, measurements must be taken over a range of distances from the source and the measurements must be repeated until sufficient confidence in their statistical properties is obtained.

For the measurements detailed herein, transects have been used, or measurements along lines radiating outwards from the source. Since the variation in noise levels with range is usually geometric the ranges are usually chosen to also increase geometrically (e.g. 100 metres, 200 metres, 400 metres).

**Draft:
Not for Public Information**

3 The measurements

This section describes the measurements that have been taken, and the instrumentation and techniques used in collecting them.

3.1 Instrumentation and measurement procedure.

The measurements made and reported herein have been measured by the transect method. Measurements have been made from a dedicated survey vessel, which was used to move from location to location along a transect. At each measurement location the hydrophone was deployed into the water mounted on an anti-heave buoy, at first at 5, then at 10 metres depth where possible. The hydrophone was allowed to drift at least 10 metres away from the vessel before measurements were taken.

The hydrophone cable was connected to the signal conditioning and digitising equipment, which is described in Appendix B. This was stored in the cabin of the vessel. Before making a recording, all extraneous noise sources such as electrical equipment and engines, were turned off. The signal was then checked for quality by both visual and audio inspection of the time history. At this point the signal conditioning settings, such as gain and pre-emphasis, were set to give the most appropriate input to the data acquisition card.

The measurement was then taken, with a record made of hydrophone depth, sea state, weather conditions, local shipping movements, signal conditioning settings, bathymetry details and measurement co-ordinates (using a GPS system). Once the recording was made, the data was checked audibly for quality; spectral analysis was performed on a segment of the recording, both as a further quality check, and to give rapid initial feedback on the type of noise being measured.

At each location a conductivity, temperature and salinity (CTD) probe was lowered over the side of the vessel to the sea bed, while the data acquisition systems logged the data. From this data a sound velocity profile may be derived; this information was archived for each measurement location.

The above process was repeated for every measurement location along a transect. During the measurements an investigative approach was used to identify and characterise noise sources, in order that their potential effects could be best evaluated.

3.2 Factors limiting the measurements

During the initial nine month period of the measurements, the work was largely reactive since it involved taking measurements of construction noise as opportunities were presented. Roughly, about half of the effort was on measurements of man-made noise sources during construction, and half on background noise. Measurements of noise were taken at all times of the day, both at night and during the daytime. Safety considerations limited the weather conditions in which measurements were made to Beaufort Force 6 and below, in moderate or lower sea state.

3.3 Description of the types of noise measured

Measurements have been taken as the opportunity arose of the following types of construction noise:

1. rock socket drilling at North Hoyle,
2. cable trenching at North Hoyle, and
3. monopile hammering at North Hoyle and Scroby Sands.

In addition, measurements have been taken of background noise at North Hoyle, Blyth and Scroby Sands to characterise the normal noise levels at each locality. Where necessary additional measurements have been taken of any predominant noise sources that exceed the expected background level, for example nearby oil and gas production. Only the data from North Hoyle and Scroby Sands is thought to currently be sufficiently comprehensive to be reported on herein.

While measurements of turbine operational noise were taken at the Blyth windfarm site on the Northeast coast during the period, these are not presented in this report as the quantity of data is not deemed adequate to provide a general description. Further measurements are planned to take place during 2004. These will include measurements at North Hoyle when the turbine array is fully operational during 2004.

3.4 The transects used for measurements.

This section describes the sites where measurements have been taken and describes in detail the transects used at these locations. These were used to estimate the source level and transmission loss of construction sources, and were additionally used when making measurements of background noise. The transect used at Blyth has been included for completeness, however the measurements made there are not currently sufficiently detailed to warrant inclusion in this report.

3.4.1 North Hoyle.

The North Hoyle Offshore Windfarm is a windfarm site operated by National Wind Power Offshore on behalf of Innogy plc. It is approximately 7.5 km north of the North Wales coast off Prestatyn and Rhyl. The site consists of an array of 30 turbines each rated at 2MW. At the commencement of this study the site was under construction and measurements were taken at regular intervals throughout the 8-month construction period. Pile hammering was investigated thoroughly. Measurements of noise from underwater drilling and cable laying were also taken. Background noise measurements were taken around the windfarm site and of the nearby oil and gas production platform BHP Douglas. The windfarm site has at the time of writing has become operational.

Figure 3 presents a sketch of the transect lines at North Hoyle. The measurements at the North Hoyle construction site have been taken along two transects, one running parallel to the shore and of reasonably constant depth, the other perpendicular to the shore line and representing a line of approximately constant slope. The two transects meet in the centre of the windfarm site. The reason for choosing the orientation of the transects is that the two cases of “constant depth” and “maximum rate of change of depth” were thought to be the two extreme cases in respect of propagation of noise.

3.4.2 Blyth.

The Blyth Offshore Wind Farm, near Newcastle in the North East of England, was the first offshore windfarm to be built in the UK. It is owned by Blyth Offshore Wind Ltd., comprises two turbines producing 4 MW of energy, and has been operating since 2000. It operates in about 8 m of water, 800 m from the shoreline. It was chosen as a subject of study for the

report because it was the only operational windfarm site in the UK at the commencement of the project. Measurements were taken at Blyth of turbine operational noise and background noise levels.

Figure 4 presents a sketch of the transects at Blyth. Because of the proximity of the turbines to the shoreline at the operational Blyth windfarm site, it was not possible to use two transects at right angles as used at North Hoyle. Therefore, measurements were taken along three transects as illustrated.

The measurements made at Blyth have not been included in this report, as they are not yet considered sufficiently complete for a full assessment of the mean and statistical information to be made.

3.4.3 Scroby Sands.

Scroby Sands offshore windfarm is, at the time of writing, under construction off the Norfolk coast near Caister-on-Sea. It represents the second major offshore windfarm development in the UK, and is owned by Powergen Offshore Renewables Ltd. The site will eventually consist of 30 2MW turbines, the nearest located 2.3 km from the shore.

The transect lines used at Scroby Sands consist of two perpendicular courses that extend from approximately the centre of the windfarm. It was not possible to use lines of roughly constant depth and maximum rate of change of depth, as North Hoyle, because it was not possible to work near to the very shallow water at South Scroby. Consequently, the transect lines chosen were about 45 and 135 degrees. Figure 5 presents a sketch of the transects.

3.5 Instrumentation and measurement procedure.

The purpose of this section is to indicate the method by which the measurements were made and analysed. Further detailed information concerning the equipment used will be found in Appendix B. The measurements made and reported herein have been measured by the transect method indicated in section 2. Measurements have been made from a dedicated survey vessel, which was used to move from location to location along transect lines. Each measurement location was identified by means of GPS. At each measurement location the measurement vessel was manoeuvred into position; the vessel's engines were stopped and all electrical equipment turned off, i.e. so the vessel was "dead in the water". Where there was significant drift due to wind or water currents, the drift was assessed and the vessel was stationed updrift of the measurement point, such that by the time of taking the measurement it would be approximately at the measurement position; the GPS information was in addition recorded onto the measurement system as measurements were made so that any error could be allowed for in the subsequent analysis. The measurement hydrophone was deployed into the water mounted on an anti-heave buoy, at first at 5, then at 10 metres depth, while measurements of noise were made. The purpose of the anti-heave buoy was to ensure that flow noise over the hydrophone, caused by it being pulled up and down in the water by wave action, did not contaminate the measurements. Wave slap from the vessel's hull was considered and investigated as a further contaminant. Boats were chosen that had a hull design giving minimum slap; it was found by listening to the recordings that in this case it did not contribute to the noise. Nevertheless, the hydrophone was allowed to drift at least 10 metres away from the vessel before measurements were taken.

The hydrophone cable was connected to the signal conditioning and digitising equipment, which is fully described in Appendix B. In brief, however, this comprised a conditioning amplifier, a spectral pre-emphasis amplifier (to ensure sufficient dynamic range was available on the recording equipment), analog to digital convertor and laptop computer. This equipment was stored in the cabin of the vessel.

Prior to acquiring any data the recorded signal was checked for quality by both listening to it, and by visual inspection of the time history. At this point the signal conditioning settings, such as gain and pre-emphasis, were set to give the most appropriate input to the data acquisition card. The measurement was then taken. Simultaneously, a record was made of hydrophone depth, sea state, weather conditions, local shipping movements, signal conditioning settings, bathymetry details and measurement GPS co-ordinates. Generally, signals were recorded for 30 seconds and at a sample rate of at least 300,000 samples per second. The high sample rate was required to ensure that the measurements could be used to estimate any environmental effect. Many marine mammals are sensitive to sound at frequencies in excess of 100 kHz; however fish are sensitive to low frequencies of say 50 Hz to 400 Hz. Hence the noise had to be recorded over a wide bandwidth of 10 Hz to 150 kHz. Once the recording was made, spectral analysis was performed on a segment of the recording, both as a further quality check, and to give feedback on the type of noise being measured.

Following the measurement at each location a conductivity, temperature and salinity (CTD) probe was lowered over the side of the vessel to the sea bed, while the data acquisition systems logged the data. From this data a sound velocity profile was derived, and this information is archived for each measurement location. Sound velocity profiles are an input that is required for sound propagation modelling programs. The purpose of this measurement was to enable information to be recorded that would, in principle, allow such modelling programmes to be used to model the propagation of noise during windfarm construction and operation. However, it should be noted that the authors are dubious whether this is, at the time of writing, of practical value.

The above process was repeated for each measurement location along a transect. During the measurements where required an investigative approach was used to identify and characterise noise sources, in order that their potential effects could be best evaluated. This led, for instance, to the identification of the Douglas Platform as a significant source of man-made noise warranting further investigation in the vicinity of the North Hoyle construction.

3.6 The processing of measurements.

3.6.1 General processing.

All of the noise sources measured during the programme may be broadly categorised into two main types. These comprise:

1. sources having periodic events of short duration such as piling, which are generally termed “impulsive noise” in this report, and
2. those of roughly constant level such as background noise and rock drilling noise, which are generally termed “steady state noise” in this report.

The importance of this distinction is that data for these two sorts of source tend to be processed in different ways.

Impulsive sounds usually have a characteristic behaviour when inspected as a record in time, and are hence usually analysed and interpreted in the time domain, by inspection of their time history. Typically, for sources such as explosive blast and piling, the measurement of most interest is their peak to peak sound pressure level, since this is related to the effect of the sound. A second quantity that is often used is the impulse I of the sound, given by

$$I = \int_0^{\infty} P(t) \delta t$$

where P is the time history of the sound as a function of time t .

While the spectrum of the impulsive sound (i.e. its frequency range) is of interest, it suffers from the disadvantage that when expressed in the conventional way as spectral level, its absolute level is dependent upon the length of time over which the measurement was made. This is one reason that the dB_{ht} measure, which avoids this problem, may be preferred.

By comparison, continuous noise is often relatively featureless in the time domain, and hence analysis is usually performed in the frequency domain, by inspection of the spectrum of the sound. The spectra itself may vary considerably from one record to another, and hence the averaged power spectral density tends to be used. In the results presented herein, the mean power spectral densities have been estimated by averaging thirty consecutive one-second recordings.

3.6.2 Perception units; the dB_{ht} (*species*)

A major thrust in the measurements has been to provide the “perceived levels” for various species, that is, the dB_{ht} (*species*) levels. Some description of this quantity is warranted here as it is a relatively new concept in the analysis of the behavioural effects of underwater noise.

Levels of sound in excess of 200 dB re 1 μPa may be recorded underwater during civil engineering activities; this corresponds to levels in excess of 170 dB re 20 μPa in the units that are used in air. Such levels are encountered in air close to, say, the takeoff of a Saturn 5 rocket, and hence environmentalists and lay members of the public are often surprised or dismayed by the levels of sound recorded. Sometimes the different physical properties of air and water are used to explain the differences, but interpretation of the significance of these levels lies in the great difference in sensitivity to sound of marine and terrestrial animals. Many marine mammals and fish are adapted for living in the noisy underwater environment, and have hearing thresholds (sensitivities of hearing) 100 dB, or 10^5 times higher than humans, that is, their hearing is 10^5 times less sensitive. For this reason, they are able to tolerate much higher levels of noise.

The human ear is most sensitive to sound at frequencies of the order of 1 to 4 kHz, and hence these frequencies are of greatest importance in determining the physical and psychological effects of sound for humans. At lower or higher frequencies the ear is much less sensitive, and humans are hence more tolerant of these frequencies. To reflect the importance of this effect a scale of sound (the dB(A)) has been developed which allows for the frequency response of the human ear. In order to estimate the physical and subjective effects of sound using this scale, the sound signal is first weighted by being passed through a filter which approximately mimics the effectiveness of human hearing. The sound is measured after

undergoing this process; the resulting sound level is expressed in decibels as 20 times the ratio of its RMS or peak pressure to a reference pressure. The levels at low (<100 Hz) and high (>10 kHz) frequencies, to which the human ear is insensitive, are reduced, and frequencies at the peak sensitivity of hearing (at 1 – 4 kHz) are weighted little or not at all. The level of sound that results may be considered to be related to the *perception* of the sound.

This approach has now been further extended to provide a generic model which enables better estimates of the effects of sound on marine species to be made, and allows biologically significant features of the sound to be identified.

The hearing sensitivity of a species is best described by its *audiogram*, which is a measure of the lowest level of sound, or threshold, that the species can hear is shown as a function of frequency. The $dB_{ht}(Species)$ level is estimated by passing the sound through a filter that mimics the hearing ability of the species, and measuring the level of sound after the filter; the level expressed in this scale is different for each species (which is the reason that the specific name is appended) and corresponds to the perception of the sound by that species. A set of coefficients is used to define the behaviour of the filter so that it corresponds to the way that the acuity of hearing of the candidate species varies with frequency: the sound level after the filter corresponds to the perception of the sound by the species. The scale may be thought of as a dB scale where the species' hearing threshold is used as the reference unit. The benefit of this approach is that it enables a single number (the $dB_{ht}(Species)$) to describe the effects of the sound on that species.

The perceived noise levels of sources measured in $dB_{ht}(Species)$ are usually much lower than the unweighted levels, both because the sound will contain frequency components that the species cannot detect, and also because most marine species have high thresholds of perception of (are relatively insensitive to) sound.

If the level of sound is sufficiently high on the $dB_{ht}(Species)$ scale, it is likely that avoidance reaction will occur. Currently, it is thought that levels of 90 $dB_{ht}(Species)$ and above cause strong avoidance reaction.

3.6.3 Processing environment and quality checks.

The measurements were processed in batches using MATLAB. The basic steps in the processing and quality checking were as follows.

1. The log file for the measurement was interrogated to find equipment settings, GPS positions and other information such as weather conditions.
2. The signal was spectrally de-emphasised.
3. The signal was converted from Volts to Pascals using the hydrophone sensitivity and amplifier gain contained in the header block.
4. The signal was high pass filtered at 10 Hz to remove any low frequency hydrodynamic noise from the passage of waves.
5. The levels of sound were calculated in dB re 1 μ Pa, either as peak level and impulse level for impulsive sounds such as piling or as sound power spectra for continuous noise such as drilling.
6. The dB_{ht} levels were calculated for selected species of fish and marine mammals.
7. Power spectral density and time histories with levels scaled to dB re 1 μ Pa and wave (.wav) files were created; each of these records was inspected for quality. Records were

checked visually using the time history to check for transients or other spurious data. The spectra were checked for tonal noise such as 50 Hz mains noise, depthfinder or sonar transmissions. Finally, every recording was listened to for spurious noises.

Data having been processed and passing the quality checks were stored for further use.

**Draft:
Not for Public Information**

4 Background noise measurements.

The background noise measurements actually include three classes of noise:

1. “background noise”, which is taken to be the level of noise pertaining in the environment when construction noise is not present. It therefore subsumes two further classes of noise:
2. “man made noise”, which includes for instance pre-existing noise caused by distant shipping¹.
3. “ambient noise”. Ambient noise is noise caused by natural processes and includes wind and wave noise, and biological noise.

4.1 Background noise in conventional units

Figure 6 summarises the measurements taken of background noise. The figure, which is slightly unusual in its presentation of the data, warrants explanation. The figure illustrates the power spectral density of the background noise as a function of the frequency; the figure indicates this quantity for all of the measurements of background noise taken (at both North Hoyle and Scroby Sands). The black line indicates the mean of the results. The red lines above and below the mean indicate the 99.7 % confidence limits of the sound measured. It may be seen that there is a significant variation in noise levels, over a range of 50 dB or more at the lower frequencies.

In addition, the colour of the plot indicates the distribution of the noise levels. The results at each frequency have been divided into 5 dB bins, and the number of results in the bin compared with the overall number of measured levels at that frequency. Thus for each centre frequency, the plot shows a histogram of the measured band levels from 16 Hz to 150 kHz. The scale appended relates the colour of the plot to the percentage of results in the bin; at the most dense (that is, where the variability was the least) 50% of the results or so fell into the 5 dB bin.

It may be seen that the variability of the levels depends significantly on frequency; with the results splitting into two bands. In the upper band, at frequencies of about 2 kHz to 100 kHz, there is little variability of the level of noise, with the results in general clustering about the mean. It is thought that this band corresponds to wind and wave generated noise. However, in the second band at frequencies below 1 kHz or so, the results spread significantly. Interpretation of these results indicates that they are due to shipping movements. When there is local movement of shipping, the levels increase significantly, however, even when there is no apparent local movement distant ships can still contribute significantly to the noise.

Illustrated on the figure are measurements of deep water background noise reported by Wenz (1962). The green lines above and below the plot indicate the upper and lower bounds of deep water ambient noise. The purple lines indicate specific features of the noise; at the low frequencies below 200 Hz the noise is dominated by shipping noise (in this case, the line for “moderate shipping” has been used). At frequencies from about 200 Hz to 10 kHz the noise results from sea surface effects; the lines indicated increase with increasing sea states.

¹ Another term which is often used to describe man made noise is “anthropogenic noise”. Strictly, the term anthropogenic relates to the study of the origins and development of humans, and there is doubt as to whether it is appropriate for describing man made noise. On the grounds of simplicity, the term “man made noise” has been used herein; nevertheless, anthropogenic noise is a term which will be found in much literature concerning man made noise.

Several differences of this data from the measurements may be identified.

1. in general, the ambient noise levels which were recorded in the shoals at North Hoyle and Scroby Sands are towards the upper bound of the deep water ambient noise levels presented by Wenz. This would tend to confirm the received wisdom that “coastal waters are noisier than deep water”.
2. For frequencies below about 1 kHz, the noise is thought to be dominated by shipping noise. For this reason, the levels are rather variable since they depend on the quantity of shipping and its proximity to the measurement position. It is interesting to note that this noise source dominates to higher frequencies than in the deep water case; this may well be a result of the smaller ships and boats that are typically found in coastal waters having higher pitched spectra.
3. From about 2 kHz upwards the level of noise in the shoals is fairly constant; unlike the Wenz results there is little dependence of the noise level on sea state. It is not certain why this should be the case. It may be that higher levels of surface noise resulting from increased wind are counteracted by poorer propagation caused by entrainment of bubbles. It may also be the case that the noise is not dominated by sea surface noise, but by other processes.
4. It should be noted that the peak in the spectrum at about 100 kHz is caused by the resonance of the hydrophone used. Since the hydrophone was fully calibrated, it was possible to “detrend” the data by applying inverse processing. It was found that this caused the spectrum to follow a line of roughly constant reduction with frequency at high frequencies.

Figure 7 illustrates the measured noise level as a function of the time of day. It is interesting to note that during the working day, from about 9 a.m. to 5 p.m., the noise varies significantly more than at other times of day. It is thought that this confirms the dependence of the low frequency spectrum on shipping noise; during the working day in coastal waters the higher number of short local ship movements leads to periodic increases in level as the each ship passes. In deep water this is not the case as deep water shipping, typically travelling on voyage of many days, must ply routes at all times of day or night. Figure 8 presents the same data, but in this case statistical measures have been applied to the data.

Figure 9 and 10 indicate the level of noise at 5 metres and 10 metres respectively, as a function of the wind speed. It is interesting to note that the noise levels in both cases are higher at low wind speeds. This is unexpected; as indicated by the Wenz results noise generally is expected to rise with increasing wind speed. It is not possible to unequivocally determine the reason for this feature of the results, but it is possible that in shoals rolling waves at the higher wind speeds drive bubbles into the water. These have a well documented action in attenuating the propagation of noise and would hence tend to reduce the area from which noise could reach any point.

Figure 11 compares the measurements taken at North Hoyle with those taken at Scroby Sands, and illustrates the power spectral density at the two sites; the results of the measurements at both 5 m and 10 m depth are shown. In general, the noise at both sites in the frequency range from 200 Hz to 10 kHz is similar. However, the noise is slightly higher at high frequencies at Scroby Sands, by up to about 10 dB. It is also about 10 dB higher at low frequencies. The reason for these differences cannot be identified from the data; indeed it was

thought that there were generally less shipping movements at Scroby Sands than at North Hoyle, so the low frequency noise would actually be expected to be lower in the former case.

Figure 12 and 13 are histograms indicating the variability of the overall sound pressure level for measurements at North Hoyle and Scroby Sands respectively. The measured SPL, at 5 m depth and 10 m depth, has been plotted as a function of the number of occurrences of the level within 5 dB bins. Figure 12 indicates that for the results at North Hoyle, the distribution of levels is centred around a mean at about 112 dB re 1 μ Pa. It is interesting to note, however, that there is a strong indication that there is a second process in operation, leading to a second peak in the noise distribution where the SPL is about 130 to 140 dB re 1 μ Pa. It is possible that this second peak indicates the influence of the Douglas Platform; if so it implies that when the platform is in production the noise levels around North Hoyle are typically raised by about 25 dB or so. It may be seen in figure 13, which illustrates the same data for Scroby Sands where there is no platform, that there is no equivalent second peak. It should be noted however that in these results the distribution is less uniform,. This results from the smaller number of measurements at Scroby Sands (40 measurements in total) when compared with North Hoyle (498 measurements in total), and serves to reinforce the importance of taking a sufficient number of measurements when reliable statistical information is required.

In summary, the measurements of ambient noise in shoals indicate the following.

1. At frequencies of about 2 kHz to 100 kHz, there is little variability of the level of noise, with the results in general clustering about the mean. It is thought that this band corresponds to wind and wave generated noise.
2. At frequencies below 1 kHz or so, there is significant variability in levels; the noise is thought to be due to shipping movements.
3. In general, the levels are towards the upper bound of the deep water ambient noise levels presented by Wenz.
4. The overall sound pressure level varies significantly more during the daytime than at other times of day, due to the higher number of short local ship movements.
5. The noise levels are higher at low wind speeds, contrary to the normal assumption that they will rise with increasing wind speed. It is not possible to unequivocally determine the reason for this.

4.2 Background noise in dB_{ht} units

As discussed in section 4.6.2, the unweighted noise levels are a relatively poor indicator of the likely behavioural effects of noise on a species, since their hearing ability and frequency range of hearing may differ greatly. In addition, since as indicated in the previous section the variability of the noise varies with frequency, the variability of the noise perceived by low and high frequency hearers will also vary.

Figures 14 and 15 are histograms illustrating the dB_{ht} levels of the background noise, for the case of the noise measured at North Hoyle, at depths of 5 metres and 10 metres respectively. Their variability has been indicated by plotting the measured dB_{ht} levels as a function of the number of occurrences of the level within 5 dB bins, in a similar manner to the preceding plots. The levels have been calculated for three fish (salmon, dab and cod) and for three marine mammals (bottlenose dolphin, seal, and harbour porpoise).

First, it is interesting to note the significant variations in the perceived noise level from species to species, confirming the unsuitability of a simple measure like the unweighted sound pressure level in estimating the behavioural effects of noise.

It may be seen that the marine mammals (dolphin, seal and porpoise) perceive a higher level of noise than the fish (salmon, cod and dab). Of these, the porpoise perceives the highest level, at a mean of about 53 dB_{ht} (*Phocoena phocoena*). This is similar, for instance, to the level that humans would perceive in an office environment. By comparison, the three species of fish (cod, dab and salmon) perceive rather lower levels, the lowest being about 15 dB_{ht} (*Salmo salar*) for the salmon. The salmon is insensitive to sound, probably as a result of adaption for noisy riverine environments.

The fish are low frequency hearers, and hence it may be seen that the variability in the low frequency noise spectrum is reflected in the variability of the perceived levels for them. By comparison, the marine mammals hear at high frequency; the variability as noted in section 5.1 is less at these frequencies and consequently it will be noted that the variability in the dB_{ht} levels is correspondingly low.

Comparison of Figures 14 and 15 shows that the results for marine mammals at 5 m depth and 10 m depth are virtually identical. The results for the fish are very similar, although it may be seen that the levels are slightly lower in the case of 10 m depth.

In summary, estimates of perceived levels of the ambient noise indicate that the three marine mammals perceive a higher level of ambient noise, associated with low variability, than the three fish species, which perceive greater variability. The porpoise perceives the highest level, of 53 dB_{ht} (*Phocoena phocoena*). This would compare to, for instance, the level of background noise that humans would perceive in a noisy office environment.

4.3 North Hoyle – Noise from the Douglas Platform

The term “background noise” can include both noise created by natural physical processes, such as wave and bubble noise, and noise created by pre-existing man-made sources, such as shipping. It is possible to rate the additional noise created by the construction and operation of a windfarm with pre-existing man made noise sources.

As measurements were taken at North Hoyle, it was noted that noise from the nearby Douglas Platform, an oil and gas facility owned by BHP, was present in some of the measurements. The Douglas Platform is situated to the North East of the North Hoyle windfarm site. The levels from the Douglas Platform were frequently found to be rather high, and the underwater noise from the platform could be heard during some of the measurements made around the windfarm site.

Figure 16 shows a typical time history of noise 500m from the Douglas Platform, with a supply vessel present and guard ship *Grampian Supporter* about 2000m away; the level is 134.7dB re 1 uPa. The spectrum of this time history is illustrated in figure 17; the mean noise spectrum from the North Hoyle site is also presented on the plot. It may be seen that the level of sound recorded from the platform is significantly above the level of background noise; audibly the noise was described as “sounding like machinery noise” with strong tonal components which can be seen on the spectra.

Measurements were taken along transects from this platform to identify the source level and transmission loss from the platform. A difficulty of these measurements is that it was apparent that the noise level from the platform varied significantly depending on whether the platform was in production. The data appeared to split into two classes of “in production” and “not in production”. Unfortunately, information as to the production state of the platform was not available to the authors.

The data is presented in figure 18. Whilst it is difficult to calculate a Source Level by a formal means, at 1km levels of about 140 dB re 1 μ Pa were recorded associated with audible indications of production. Assuming a Transmission Loss of $22 \log(R)$, a Source Level of 206 dB re 1 μ Pa @ 1 metre results.

**Draft:
Not for Public Information**

5 Construction noise measurements

This section presents measurements of man-made noise during construction. The measurements concentrated on piling, which was identified as a priority for measurements early in the program.

The windfarms at North Hoyle and Scroby Sands use monopile turbine support structures, in which the turbine is supported on a single large pile that is driven into the seabed. Appendix C details the general construction procedure for installing of a turbine, which makes use of impact piling.

Impact piling is performed by first inducing downward velocity in a heavy metal ram. Upon impact with the pile the ram creates a force far larger than its weight, which moves the pile an increment into the ground. Some impact hammers have a cushion, typically of hardwood, under the end of the ram that receives the striking energy of the hammer. This cushion is necessary to protect the striking parts from damage; it also modulates the force-time curve of the striking impulse and can be used to match the impedance of the hammer to the pile, increasing the efficiency of the blow.

In the initial stages of construction, the pile is typically driven as far as possible by impact piling. If the sediment compacts such that the pile will not advance, or if the pile encounters hard rock, an internal drill is used to remove the obstruction prior to further driving taking place.

The seabed substrate at North Hoyle consists mainly of hard rock and sediment and therefore the program required a three-stage approach to the installation of turbine support structures. In brief, this involved an initial period of impact hammering to drive the pile to half depth. This was then followed by a period of about 20 hours of drilling using a drill head lowered inside the pile. This allowed the pile in the final stage to be hammered to its final depth. However, the seabed at Scroby Sands consists mainly of sand and thus in this case there was no requirement for drilling during the turbine installation procedure.

5.1 Piling at North Hoyle

5.1.1 Measurements of piling at North Hoyle, conventional units.

The North Hoyle programme involved driving 30 piles over a period of about 5 months. The piles had a diameter of 4 m, a wall thickness of 35 mm, a weight of about 270 tonnes and a nominal length of 50 m. They were driven using a Menck MHU500T piling hammer. The average impact energy used to drive the piles was 450KNm and the average number of blows per minute was 35.

Figures 17, 18 and 19 indicate time histories of piling noise measured at 955 metres, 1881 metres and 3905 metres from the piling respectively, and at a depth of 5 metres. The vertical scale represents the pressure level in Pascals; the horizontal axis represents time in seconds. In all cases it can be seen that while the peak pressure falls as range from the piling increases, the pressure impulse of the pile strike is greatly in excess of the background noise levels at all ranges. It may be seen that the level is high, having peak to peak levels of 184 dB re 1 μ Pa, 192 dB re 1 μ Pa and 198 dB re 1 μ Pa respectively. The piling noise is characterised by a first waterborne impulse having a rapid rise to a maximum level, followed by a ringdown period of

about ½ second. It was noted that faint “echoes” could be detected following the direct arrival; these were thought to be due to seismic (substrate-borne) arrivals. At the larger ranges, a seabed borne wave could be detected arriving shortly before the main arrival.

Figure 20 shows the 1/27th octave smoothed energy spectra of the same measurements. It can be seen that

1. Most of the energy is between 40Hz and 1KHz and that the spectral content of the signal does not change appreciably with range.
2. There are some tonal features evident at 200, 250, 600, 800 and 1600Hz, which are common to each of the measurements.

Figure 21 is a spectrogram of the measurement taken at 955 m and shows the variation of frequency content with time for frequencies up to 25 kHz over a period of 1.5 seconds. It is useful for identifying the contributions from different transmission paths and sources to the overall level. The main waterborne arrival of the pile strike noise is marked as “2” in the figure. This is characterised by the arrival of a wide range of frequencies, with the highest frequencies decaying most quickly and the lower frequencies decaying more slowly. There is evidence of head waves, or seismic precursors, arriving before the main waterborne arrival; these can arrive before the waterborne arrival as the speed of sound through the substrate is greater than through water. Following the waterborne wave there are further seismic or waterborne arrivals, marked “4” in the figure. The same tonal components found in figure 20 may be seen; these result in horizontal lines (i.e. at constant frequency) at approximately 200, 250, 600, 800 and 1600 Hz. which are marked 3 in the figure and could be heard as “ringing” of the pile following the strike. These are thought to be due to resonances of the steel pile.

Figure 22 illustrates the same data as figure 21, but over a wider frequency range of up to 150 kHz. It may be seen that there is a significant energy component up to at least 100 kHz. This is of significance since many marine mammals have hearing ranges which extend up to these frequencies.

Figures 23 and 24 show spectrograms of the measurements taken at 1881 m and at 3905 m, for frequencies up to 25 kHz. The ringing and reflections are still evident, but less pronounced at these greater ranges.

Figure 25 shows the measured peak pressure from the North Hoyle pile hammering measurements plotted against range. Since each recording at each position contained many pile strikes, the average peak pressure has been used; each point therefore represents the average peak pressure over the record, on average about 22 pile strikes. In fact, the individual pile strike levels were relatively constant. The measurements show that the level of noise falls evenly with range in all directions, that is, that there are no preferential directions for propagation of noise.

In order to quantify the measurements and to provide generic information that may be used in future estimates of environmental effect, Transmission Loss (TL) and Source Level (SL) models have been fitted to the measured peak pressure from the source as a function of range. These are essentially a best fit line through the data; the Transmission Loss is effectively the level at a range of 1m and the Transmission Loss represents the gradient of the line. A further explanation of SL and TL is given in Appendix A.

Figure 26 presents the peak pressure measured at 5 metres depth from the North Hoyle pile hammering measurements. A SL/TL model has been fitted to this data. The model indicates that the effective Source Level of the piling noise is 260 dB re 1 μ Pa @ 1 metre. The corresponding Transmission Loss is given by $22 \log(R)$ where R is the range. The latter value of TL is similar to values that have been found for a variety of other noise sources.

A similar Transmission Loss may be calculated for the results at 10 metres depth plotted in figure 27; the Source Level is in this instance slightly higher at 262 dB re 1 μ Pa @ 1 metre.

5.1.2 Measurements of piling at North Hoyle, dB_{ht} units.

Figures 28 and 29 illustrate the calculated dB_{ht} levels for the measurements of piling at North Hoyle, at 5 metres depth and 10 metres depth respectively. On each figure, the levels have been plotted for three species of marine mammals and three species of fish. For each species, the corresponding Source Level and Transmission Loss have been calculated; these are plotted on the figure and the values appended in the table attached to the figure. Also illustrated on the figure is a threshold of 90 dB_{ht} which has been suggested as a threshold at which a “strong avoidance reaction” threshold will occur.

About 75% of the measurements are in excess of this value, indicating that strong avoidance reaction by a range of species would be likely at the ranges at which measurements were made. The ranges within which these reactions would be expected have been calculated from this data and are tabulated in Table 1 below.

Species	Calculated avoidance range
Salmon	1400 m
Cod	5500 m
Dab	1600 m
Bottlenose Dolphin	4600 m
Harbour Porpoise	7400 m
Harbour Seal	2000 m

Table 1. Calculated ranges for avoidance reactions as a function of species.

In the only direct observation of reaction of harbour porpoise to piling which the authors are aware of, by Tougaard et al (2003), the short-term effects of the construction of wind turbines on harbour porpoises at Horns Reef in Denmark were monitored by passive acoustic monitoring and Marine Mammal Observers (MMOs). It was concluded that impact piling reduced the activity of harbour porpoises in the entire Horns Reef area, at ranges of up to 15 km from the piling. Since the criterion used in the analysis of the North Hoyle data was for “strong avoidance reaction” a milder reaction would be expected to greater ranges, and hence the conclusions of the analysis presented above and the data presented by Tougaard are consistent.

In summary, the levels of sound recorded during piling are such that they could cause behavioural effects (avoidance behaviour) of both marine mammals and fish at several

kilometres from the piling. Further work is required to confirm whether or not this is the case, and if so the range at which these effects occur.

5.1.3 Measurements of piling at North Hoyle; possible physical effects of piling noise on fish

Underwater noise emissions can cause fish injuries, although these normally occur only at high sound pressure levels. Such injuries are known as ‘barotraumas’. Typical effects of rapid pressure change include over-expansion and rupture of the swimbladder and formation of gas embolisms in the bloodstream, especially in the eyes (Turnpenny & Nedwell, (1994). Eye injuries are often seen as haemorrhages or protrusions of the eye caused by gas release. The interfaces between body tissues and gas cavities such as the swimbladder can be sites for cavitation damage during the passage of pressure waves and tissues here are vulnerable to breakdown. Repeated exposure, e.g. from driving large piles in close proximity, can lead to damage to the internal tissues of a fish.

In northern California caged Pacific salmon (*Onchorhynchus spp.*) were held at various distances from pile-driving being undertaken for a major road crossing (Abbott, (2002)). At close range injuries of the type described above were observed. The kill range for young salmon was estimated at 700 m, and significant fish mortality was noted during the programme. The piles were half the size of those used in the North Hoyle project (2.4 m dia. cf. 4 m dia). The measured noise levels for the piles being driven (without any attenuation measures being taken) are shown in Table 2.

It is interesting to convert these values to a source level (SL) using the same transmission loss (TL) as used in the North Hoyle results. In this case, a SL of 247 to 257 results for the measurements at 103 metres, and 249 to 259 dB re 1 µPa @ 1m for the results at 358 metres. This implies both that the scaling is appropriate (because it gives similar source levels for results at two different distances). Since the Source Level of the North Hoyle piling is higher than this figure, the level of noise from the piling at North Hoyle is probably sufficient to cause local fish kill.

Distance between pile driving and measurement locations [m]	Peak sound pressure level [dB re 1 µPa]
103	197 – 207
358	181 - 191

Table 2. Measured peak sound pressure levels as a function of range, from Abbott (2002).

Draft:
Not for Public Information

It may be questioned whether there is any possibility of injury to marine mammals in the vicinity of the piling. There is no information directly concerning injury to marine mammals caused by piling, but information from underwater blast may be sufficient to provide a first-order estimate of its effects. Hill (1978) provides a useful review dealing with the mechanisms and sites of explosion damage in submerged land mammals and showing, in contrast, the relative resilience of marine mammals, owing to specialised adaptations to diving. These include, for example, strengthened lungs and air passages in seals and mechanisms to equalise the pressure in air spaces in the head and lungs with that of the surrounding water.

For predicting lethal range, the Yelverton *et al.* (1973) model has been widely used for marine mammals. The critical impulse levels given by Yelverton are tabulated in Table 3. It should be noted that the observations were made on submerged terrestrial animals (sheep, dogs, monkeys) weighing between 5kg and 40kg. Hill (1978) suggested that these could yield overestimates, owing to the adaptations to pressure change of diving mammals, and increased thickness of the body wall.

Impulse (dB re 1 μ Pa/s)	Impulse (Pa.s)	Impulse (bar.msec)	Likely effects, from Yelverton.
169	276	2.76	No mortality. High incidence of moderately severe blast injuries, including eardrum rupture. Animals should recover on their own.
163	138	1.38	High incidence of slight blast injuries, including eardrum rupture. Animals should recover on their own.
157	69	0.69	Low incidence of trivial blast injuries. No eardrum ruptures.
151	34	0.34	Safe level. No injuries.

Table 3 Summary of effects of different impulses on mammals diving beneath the water surface (from Yelverton *et al.*, 1972).

Figures 31 and 32 illustrate the impulse level of the noise from the piling at North Hoyle as a function of range. The Impulse Source Level of the piling is 212 dB re 1 μ Pa.s at 1 metre at a depth of 5 metres associated with a Transmission Loss of 26 log (R); at 10 metres depth the equivalent quantities are 202 dB re 1 μ Pa.s @ 1 metre and 22 log (R).

If 163 dB re 1 μ Pa.s is used as the threshold at which injury may occur, it may be calculated that injury might occur to marine mammals within ranges of 77 metres at 5 metres water depth, and 60 metres at 10 metres water depth.

In summary, the levels of sound recorded during piling are such that in the immediate vicinity of piling, say within a hundred metres or so, the underwater noise could cause injury. Further work is required to confirm whether this is the case, and the range at which injury occurs.

5.2 Impact Pile Driving at Scroby Sands

The Scroby Sands windfarm construction program commenced late in October 2003 with the monopile foundations completed by the end of the same year. The foundation piles were installed using a single impact piling session without a requirement for rock socket drilling as at North Hoyle. Though permission for was granted for the installation of 38 turbines, only 30 were installed. The monopiles have a diameter of 4.2m and range in length from 40 to 50m.

The piles are driven into the sand to a depth of 35m and protrude a nominal 8m above sea level. The turbine structures will when completed have a height of 60m, with the blades each 39m long.

The results of the measurements are illustrated in figure 33. The results have been plotted over the corresponding results from North Hoyle. The best fits of Source Level and Transmission Loss have been overlaid on the results for the North Hoyle results at 5 and 10 metres, and the Scroby Sands results at all depths. It may be noted that, due to the very shallow water at Scroby Sands, some of the measurements are at 1 metre and 2 metres depth.

In general, the levels are similar to those at North Hoyle. There is, however, a significant difference in that the apparent Transmission Loss is very high at about 35 log (R), associated with a high apparent Source Level of 297 dB re 1 μ Pa @ 1 metre. These values differ greatly from both the North Hoyle presented herein and also from other measurements the authors have made. It is clear that in this case the Source Level is unrealistically high. This may partly be due to the number of measurements made at Scroby Sands being lower than for North Hoyle, such that the quality of fit of Source Level and Transmission Loss was poor. It is also probable that had measurements been made at closer ranges, the actual levels would have been much lower than the “straight line” model would predict. The high levels probably result from the complex bathymetry of the site and very shallow water in which the piling was conducted leading to a relatively high level at the closest ranges at which measurements were made. This could arise, for instance, from the partial focussing in the shallow water around the piling of the waterborne and seismic waves.

The result points to the importance of using empirical information with care. The acoustic properties of the site should be considered carefully when using empirical models to predict the level of sound that will result from a piling operation, to ensure that the model is appropriate. In cases where the acoustical, bathymetry or seabed properties are significantly different from those for which the empirical models have been developed, use of suitable acoustic modelling programs or ideally direct measurement of transmission should be considered.

Since the measurements at Scroby Sands were similar in level to those at North Hoyle, similar conclusions pertain in respect of environmental effects.

5.3 Cable Trenching at North Hoyle

During the installation of the cables at North Hoyle, measurements were made of the noise levels created by trenching of cables into the seabed.

Figure 34 presents a typical time history, recorded at a range of 160 metres from the trenching with the hydrophone at 2 metres depth; this was necessary because at the time the measurements were being made the work was being undertaken in very shallow water. The sound pressure level of this recording was 123 dB re 1 μ Pa.

The trenching noise was found to be a mixture of broadband noise, tonal machinery noise and transients which were probably associated with rock breakage. It was noted at the time of the survey that the noise was highly variable, and apparently dependent on the physical properties of the particular area of seabed that was being cut at the time.

Figure 32 is the power spectral density of the measurement illustrated in figure 35. It may be seen that the spectrum is broadband, with some energy at 50 kHz and above, although in general it is only some 10 – 15 dB above the level of background noise. It is assumed that the peak in the spectrum at 40 kHz is due to the use of baseline sonar for positioning. Because of the variability of the noise, it is difficult to establish the unweighted Source Level of the noise, but if a Transmission Loss of $22 \log(R)$ is assumed, a Source Level of 178 dB re 1 μPa @ 1 metre results.

5.4 Rock Socket Drilling Noise at North Hoyle

As noted in section 5.3, the seabed substrate at North Hoyle was mainly of hard rock and sediment and after initial impact hammering about 20 hours of drilling were required to allow the pile to be hammered to its final depth.

Figure 36 shows the time history of a typical measurement of drilling noise. The measurement was taken at a range of 160 metres away from the jack up barge *Excalibur*, which was conducting the pile installation. The time history consists mainly of tonal noise, possibly associated with meshing noise from gearbox drives.

Figure 37 illustrates the power spectral density of the measurement. The measurement is compared with the mean background noise from the North Hoyle windfarm site. It may be seen that in general above 100 Hz there is significant tonal noise, leading to peaks in the spectrum 5 – 15 dB above the level of background noise. Strong peaks are identifiable at approximately 125, 250 and 375 Hz, but there are also lower level peaks at a wide range of frequencies. There is also evidence of tonal noise at lower frequencies, although, due to the processing used, the lower frequency peaks are not clearly visible as they have been smeared by the bandwidth of the processing (1 Hz). Some evidence of higher frequency noise swaths can also be seen at higher frequencies, up to 8 kHz. It should be commented that although there is an apparent increase in level from frequencies of 20 kHz and above, this is due to the measurement reaching the noise floor of the recording; the flat region indicates the high frequency electrical noise floor. This could not be avoided because even with pre-emphasis the dynamic range was greatly increased by transients and tonal peaks.

Unfortunately, the variation in levels recorded during drilling were such that it is difficult to establish the Source Level and Transmission Loss from the data.

Figure 38 shows power spectral density plotted against range from the source. The plot was created using 78 measurements of drilling noise. The plot shows the strong fundamental component at 125Hz, and harmonics up to 1KHz, as seen in figure 37. The level of these components can be seen to fall away as range from the source increases. The horizontal red patches represent other dominant noise sources present at the time of measurement, mainly shipping traffic, which exhibits a broadband noise signature centred around 100Hz. It is interesting to note that components of the drilling can be identified at ranges of up to 7 km.

6 Mitigation measures for piling.

This section addresses only piling, although many of the strategies identified here will also be useful for other sources of noise.

6.1 How piling creates noise

A brief description of the method by which noise from a pile being impact driven radiates into water is appropriate. First, it should be noted that the mechanics of noise generation and propagation during piling are not well understood. However, many of the features of noise propagation from piling are similar to blast wave generation and propagation during underwater blasting, and it is possible to identify common features in time histories of the underwater pressure from both.

Noise is created in the air by the hammer, partly as a direct result of the impact of the hammer with the pile. Some of this airborne noise is transmitted into the water, however, of more significance in underwater noise is the radiation of noise from the surface of the pile as a consequence of the compressional, flexural or other complex structural waves that radiate down the pile following the impact of the hammer on its head.

Figure 39 illustrates the paths by which the noise propagating from a pile may travel to a distant underwater point when it is struck by a pile driving hammer. The routes comprise:

1. **The airborne path.** Airborne noise caused by the impact and the radiating structural waves propagates through the air, and eventually passes down into the water. While this path exists, it is very inefficient at transferring noise to the water for three reasons. First, there is a great difference in densities of air and steel and hence the transfer of energy between pile and air is inefficient. Second, due to diffraction sound is only transferred efficiently into water from overhead airborne sources. Third, much of the energy of the sound is in any case reflected back from the air/water interface. Consequently, the airborne path is not likely to be a significant contributor to underwater noise.
2. **The waterborne path.** In this path, the waves radiating down through the pile encounter the water. Water is of similar density to steel, and in addition due to its high sound speed (1500 metres/sec as opposed to 340 metres/sec for air) waves in the submerged section of the pile may efficiently couple into waves travelling in the water. These waterborne waves will radiate outwards, usually providing the greatest contribution to underwater noise.
3. **The groundborne path.** At the end of the pile, force is exerted on the substrate not only by the mean force transmitted from the hammer by the pile but also by the structural waves radiating down the pile inducing lateral waves in the seabed. These may travel as both compressional waves, in a similar manner to the sound in the water, or as a seismic wave, where the displacement travels as Rayleigh waves. The waves can travel outwards through the seabed, or by reflection from deeper sediments, and as they propagate sound will tend to “leak” upwards into the water, contributing to the waterborne wave. Since the speed of sound is generally greater in consolidated sediments than in water, these waves usually arrive first as a precursor to the waterborne wave.

6.2 Quantification of likely effects.

The levels of sound presented herein recorded during piling are such that they probably could cause behavioural effects (avoidance behaviour) of both marine mammals and fish at a

distance of several kilometres from the piling. The results also indicate that in the immediate vicinity of piling, say within a hundred metres or so, the underwater noise could cause injury.

This cannot be quantified and ranked in importance as an environmental effect without knowledge of

1. the species that might be present,
2. their sensitivity to the noise for a particular effect and hence the area around the piling that might be effected,
3. the population density, such that the number of individuals that might be in this effected area can be calculated, and
4. the significance of the effect, or the risk of that effect, on those individuals or their stock.

All of these parameters are of significance in quantifying the degree of effect.

In some cases, a given effect of the piling may, in itself, be of no environmental significance. For instance, a behavioural effect in which fish or mammals are simply displaced from the area of the piling to another area of similar habitat might be unimportant. However, if they are displaced away from their feeding grounds, are an endangered species, or a foodstock for one, the effect may well be important.

This indicates why in the initial stages of planning a piling operation, it should be regarded as capable of causing significant environmental effect, and planning of piling operations should take account of the effects of its noise on sensitive species. If the environmental consequences of the piling operation are deemed unacceptable, then use must be made of suitable mitigation measures to reduce the impact to an acceptable level.

6.3 Mitigation measures.

The aim of mitigation is to control and minimise the environmental impact of a piling operation, and comprises control of noise at source, mitigation by use of engineering and other factors, and monitoring of the results.

6.3.1 Control at source.

Options that can be considered to minimise the noise from piling at source include

1. **Good engineering.** providing attenuation of the piling noise by appropriate engineering. Good engineering is of prime importance, and using the correct specification of pile driver for the job and avoiding situations where excessive energy might have to be used is likely to be of key importance when determining noise levels.
2. **Pile diameter.** It has been found that the pile diameter is closely related to the noise level. Recorded noise levels during the driving of smaller piles have been found to be lower than for larger piles. It might therefore be possible to use two or three small piles to replace one large monopile. However, it should be noted that the effect of pile diameter on noise is not yet fully researched, and that the lower noise levels may be counterbalanced by the increased time taken to drive several smaller piles.
3. **Bubble curtains.** Bubble curtains, or ascending curtains of bubbles from bubble pipes on the seabed, have been used to attenuate both blast and piling noise, but where their

efficiency has been evaluated they typically only offer small improvements. It should also be noted that they will only reduce the waterborne wave.

4. **Vibropiling.** Vibratory pile drivers are machines that drive piling into the ground by applying a rapidly alternating force to the pile, created by rapidly rotating eccentric weights. They are usually quieter than impact piling, but may not be capable of fully driving a pile into hard seabeds.

6.3.2 Non engineering methods.

Other control methods include

1. **Scheduling.** Work may be scheduled for periods when the species are not in the area, for instance by avoiding migratory periods or periods where local breeding grounds are used. It should be noted however that this information is sometimes incomplete or difficult to obtain.
2. **Acoustic harassment devices.** Acoustic harassment devices or AHDs are devices that generate high levels of underwater noise, such that a given species move out of the area. These include seal scramblers, and fish guidance systems. Both of these work effectively at short ranges, and hence might be effective at reducing the possibility of fish kill or marine mammal injury near the piling.
3. **Soft start.** In this approach, the behavioural effects of the noise are used to prevent injury. Piling commences at low energy levels, building up slowly to full impact force, in principle reducing the risk of injury to species by giving them time to flee the area.
4. **Observation.** It is sometimes possible to watch for species visually, for instance using Marine Mammal Observers (MMOs), and to cease piling while target species are in the area. This approach is mandatory in offshore seismic surveys. However, many species are difficult to observe; in addition the approach does not work at night. Some use has been made of Passive Acoustic Monitoring (PAM) to detect vocalising species. In the longer term it may be possible to use active or acoustic daylight sonar systems to detect non-vocalising species, but at the moment this is unproven technology.

6.3.3 Monitoring.

Monitoring is an important component in mitigation, in that it enables control to be kept over noise levels, and this to be demonstrated to interested parties. It also enables the noise created by a piling operation to be ranked against other local sources of noise. The monitoring can include:

1. **Noise monitoring.** Fixed distance noise monitoring, as described in section 2.5.1, may be used to keep a record of noise levels and to provide an appropriate reaction if these are excessive. Ideally, monitoring should include “real time” feedback of the levels to contractors. Sometimes monitoring is associated with a trigger limit at which the contractor is required to stop work, find the cause of the excessive noise level and remedy it.
2. **Caged fish trials.** Caged fish trials may be used to monitor or confirm the reaction of locally important fish, or lack of it, to the noise. This may have two purposes, either to demonstrate that there is no effect, or, if an effect is observed, to identify the level at which it occurs. This has a benefit in the long term of providing information which may be used to guide future piling projects.

- 3. Marine mammal observation.** The monitoring of local mammals, for instance by observing local haul-out areas, by tagging, or by using passive acoustic monitoring to detect vocalisation. This is undertaken for the same reasons as the caged fish trials above.

**Draft:
Not for Public Information**

7 Summary and conclusions.

A good quality set of measurements have been made on an opportunity basis of underwater ambient noise in typical windfarm areas, and of typical sources of noise during construction.

- 1 The measurements of ambient noise in shoals indicates that in general, the levels are towards the upper bound of the deep water ambient noise levels presented by Wenz. The overall sound pressure level varies significantly more during the daytime than at other times of day, due to the higher number of short local ship movements. The noise levels are higher at low wind speeds, contrary to the normal assumption that they will rise with increasing wind speed. It is not possible to unequivocally determine the reason for this.
- 2 Estimates of the dB_{ht} levels (perceived levels) of the background noise at North Hoyle indicate that typical marine mammals perceive a higher level of ambient noise, associated with low variability, than typical fish species, which perceive greater variability. The porpoise perceives the highest level, of 53 dB_{ht} (*Phocoena phocoena*). This would compare to, for instance, the level of background noise that humans would perceive in a noisy office environment.
- 3 The Douglas Platform is probably a significant pre-existing contributor to the background noise level at North Hoyle. Its Source Level may be estimated to be about 206 dB re 1 μ Pa @ 1 metre.
- 4 Measurements of piling at North Hoyle indicated a Source Level of 260 dB re 1 μ Pa @ 1 metre for 5 metres depth, and 262 dB re 1 μ Pa @ 1 metre at 10 metres depth, associated with a Transmission Loss given by $22 \log(R)$ where R is the range. Calculations using the dB_{ht} scale levels indicate that strong avoidance reaction by a range of species would be likely at the ranges of up to several kilometres. The levels of sound recorded during piling are such that within perhaps a hundred metres they could cause injury.
- 5 Measurements of piling at Scroby Sands were similar in level to those at North Hoyle, and similar conclusions pertain in respect of possible environmental effects.
- 6 Measurements of cable trenching at North Hoyle indicate a Source Level of 178 dB re 1 μ Pa @ 1 metre if a Transmission Loss of $22 \log(R)$ is assumed.
- 7 Measurements of rock socket drilling were made, which showed strong fundamental component at 125Hz, and harmonics up to 1Khz, but it was not possible to establish the Source Level and Transmission Loss. Components of the drilling could however be identified at ranges of up to 7 km.
- 8 On the basis of the measurements, piling in particular should be regarded as capable of causing significant environmental effect, and planning of piling operations should take account of the effects of its noise on sensitive species. If the environmental consequences of the piling operation are unacceptable, then use must be made of suitable mitigation measures to reduce the impact to an acceptable level.

8 Figures.

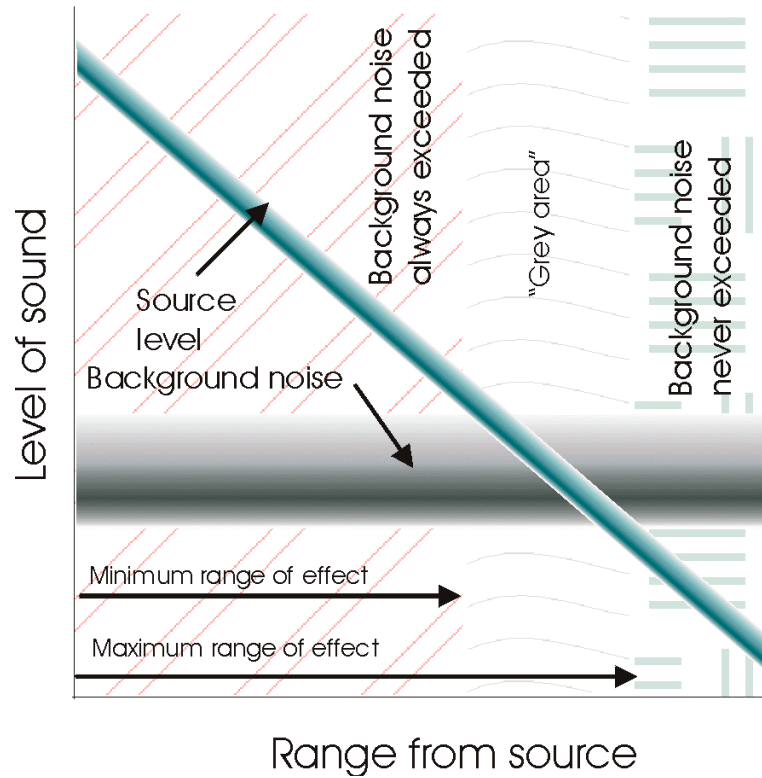

Figure 1 A model of the noise from a source, and ambient noise, where levels vary.

Draft:
Not for Public Information

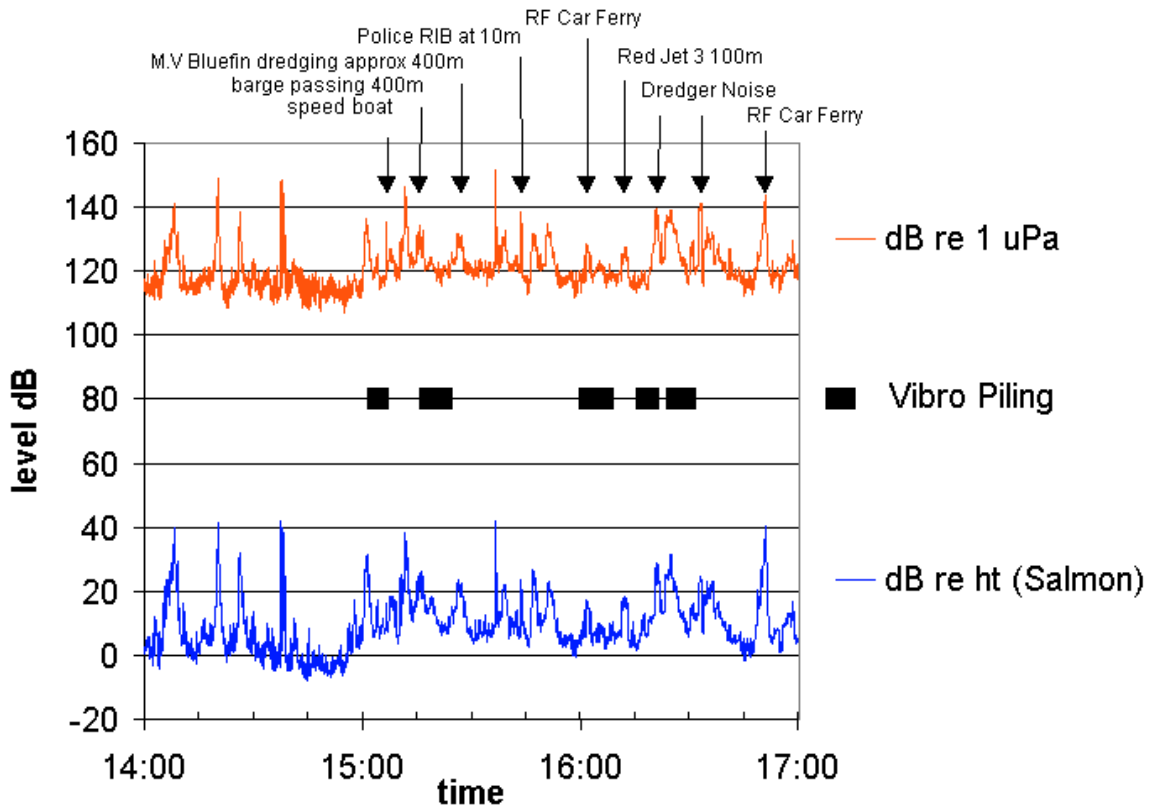
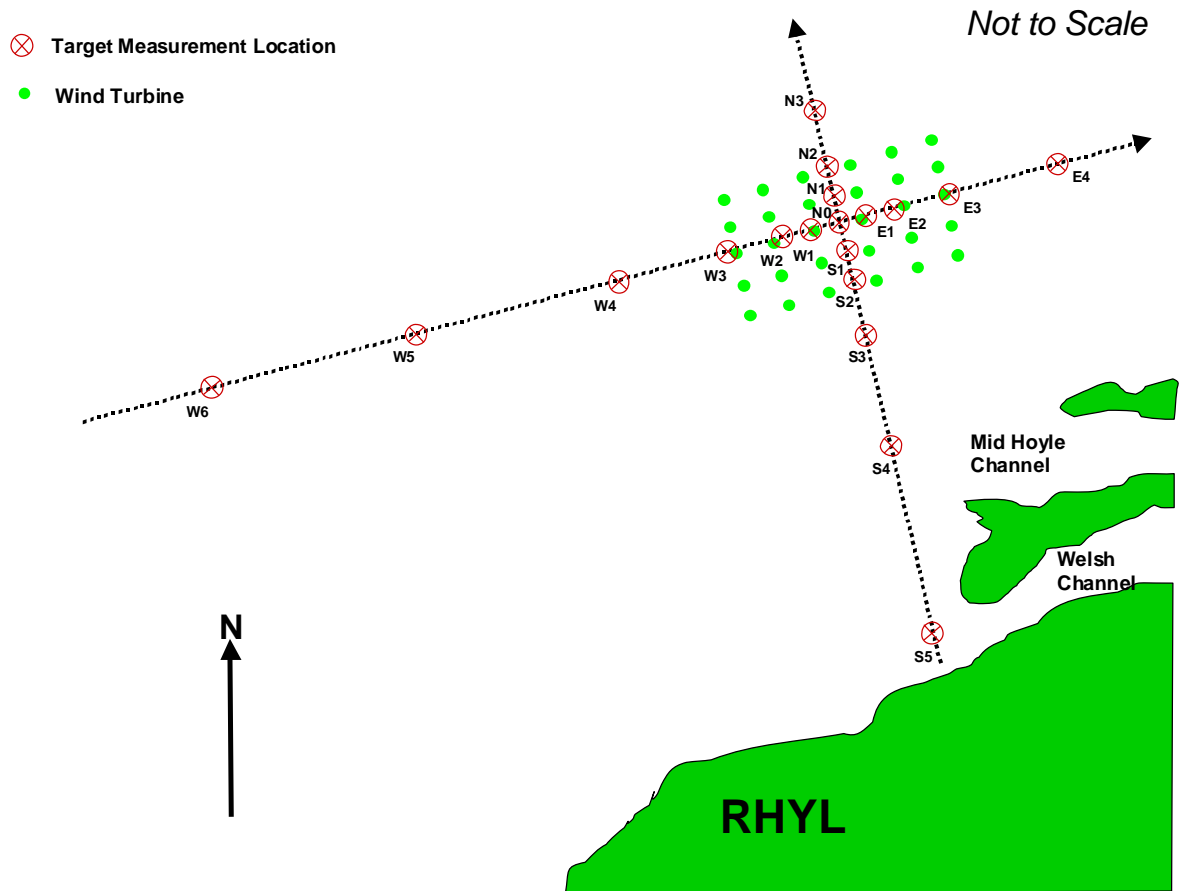

Figure 2 An example of the monitoring approach to noise measurements, from Nedwell *et al* 2003.

Draft:
Not for Public Information



Label	Dist [m]	Bearing [True]	Calculated Position	Label	Dist [m]	Bearing [True]	Calculated Position
N0	0	N/A	53.25.000N 03.26.700W	S1	250	169	53.24.867N 03.26.685W
N1	250	1	53.25.135N 03.26.696W	S2	500	169	53.24.735N 03.26.669W
N2	500	349	53.25.265N 03.26.786W	S3	1000	169	53.24.470N 03.26.639W
N3	1000	349	53.25.530N 03.26.873W	S4	2000	169	53.23.940N 03.26.577W
N4	2000	349	53.26.060N 03.27.046W	S5	4000	169	53.22.880N 03.26.454W
N5	4000	349	53.27.120N 03.27.392W	S6	6000	169	53.21.820N 03.26.331W
N6	6000	349	53.28.180N 03.27.738W	W1	250	258	53.24.972N 03.26.779W
E1	250	78	53.25.028N 03.26.621W	W2	500	258	53.24.944N 03.26.857W
E2	500	78	53.25.056N 03.26.543W	W3	1000	258	53.24.888N 03.27.015W
E3	1000	78	53.25.112N 03.26.385W	W4	2000	258	53.24.775N 03.27.330W
E4	2000	78	53.25.225N 03.26.070W	W5	4000	258	53.24.551N 03.27.959W
E5	4000	78	53.25.449N 03.25.441W	W6	6000	258	53.24.326N 03.28.589W

Figure 3. Measurement transects at North Hoyle

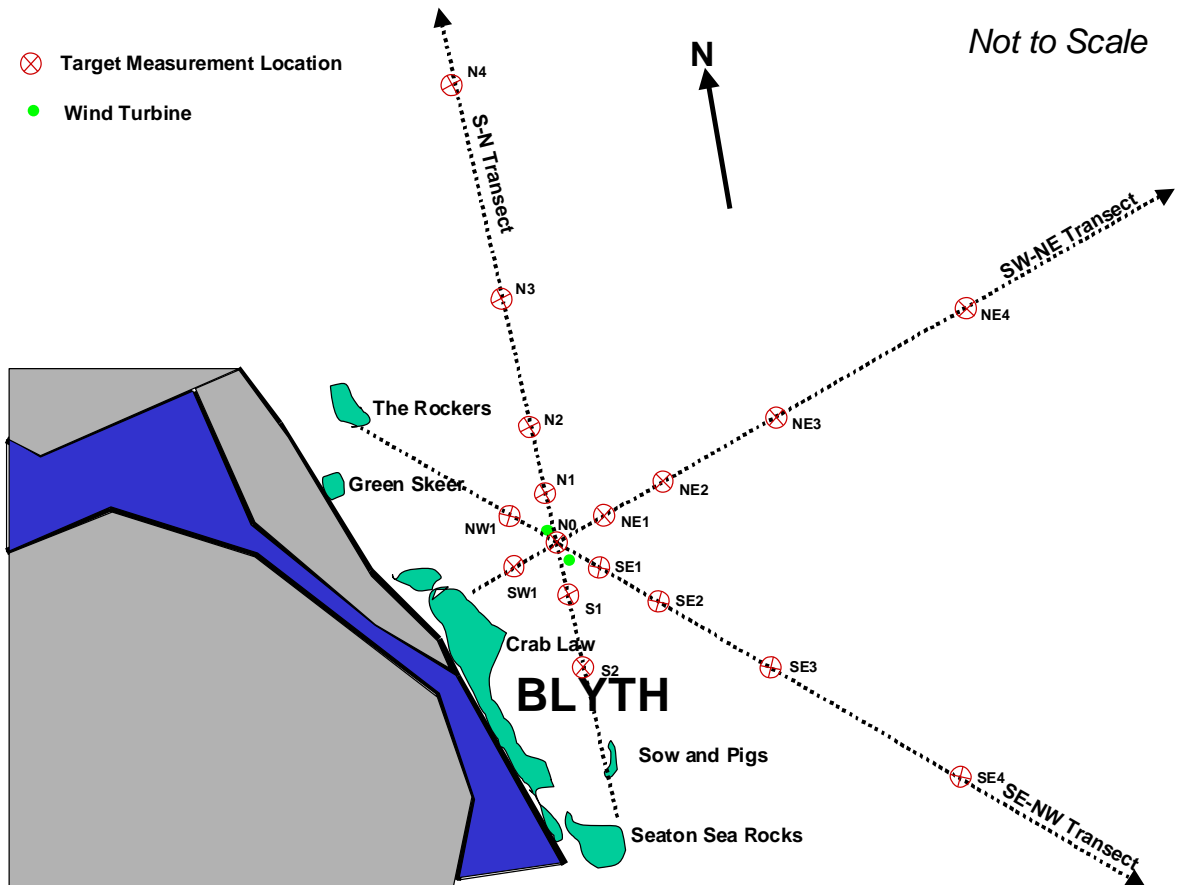

Label	Dist [m]	Bearing [True]	Calculated Position	Label	Dist [m]	Bearing [True]	Calculated Position
N0	0	N/A	55 29.430N 01 08.190W	SE1	250	114	55 29.230N 01 08.130W
N1	250	350	55 29.450N 01 08.320W	SE2	500	114	55 29.000N 01 08.070W
N2	500	350	55 29.470N 01 08.480W	SE3	1000	114	55 28.570N 01 07.970W
N3	1000	350	55 29.500N 01 08.750W	SE4	2000	114	55 27.800N 01 07.750W
N4	2000	350	55 29.550N 01 09.300W	SE5	4000	114	55 25.910N 01 07.280W
N5	4000	350	55 29.750N 01 10.040W	SE6	8000	114	55 22.800N 01 08.400W
NE1	250	66	55 29.220N 01 08.250W	E1	250	170	55 29.400N 01 08.050W
NE2	500	66	55 29.000N 01 08.300W	E2	500	170	55 29.380N 01 07.940W
NE3	1000	66	55 28.570N 01 08.420W	EW1	250	245	55 29.850N 01 08.140W
NE4	2000	66	55 27.800N 01 08.620W	EW2	500	245	55 29.880N 01 08.090W
NE5	4000	66	55 25.9140N 01 09.150W	NW1	250	294	55 29.850N 01 08.250W
NE6	8000	66	55 22.800N 01 09.800W	NW2	500	294	55 29.870N 01 08.320W

Not for Public Information

Figure 4. Measurement transects at the Blyth windfarm site

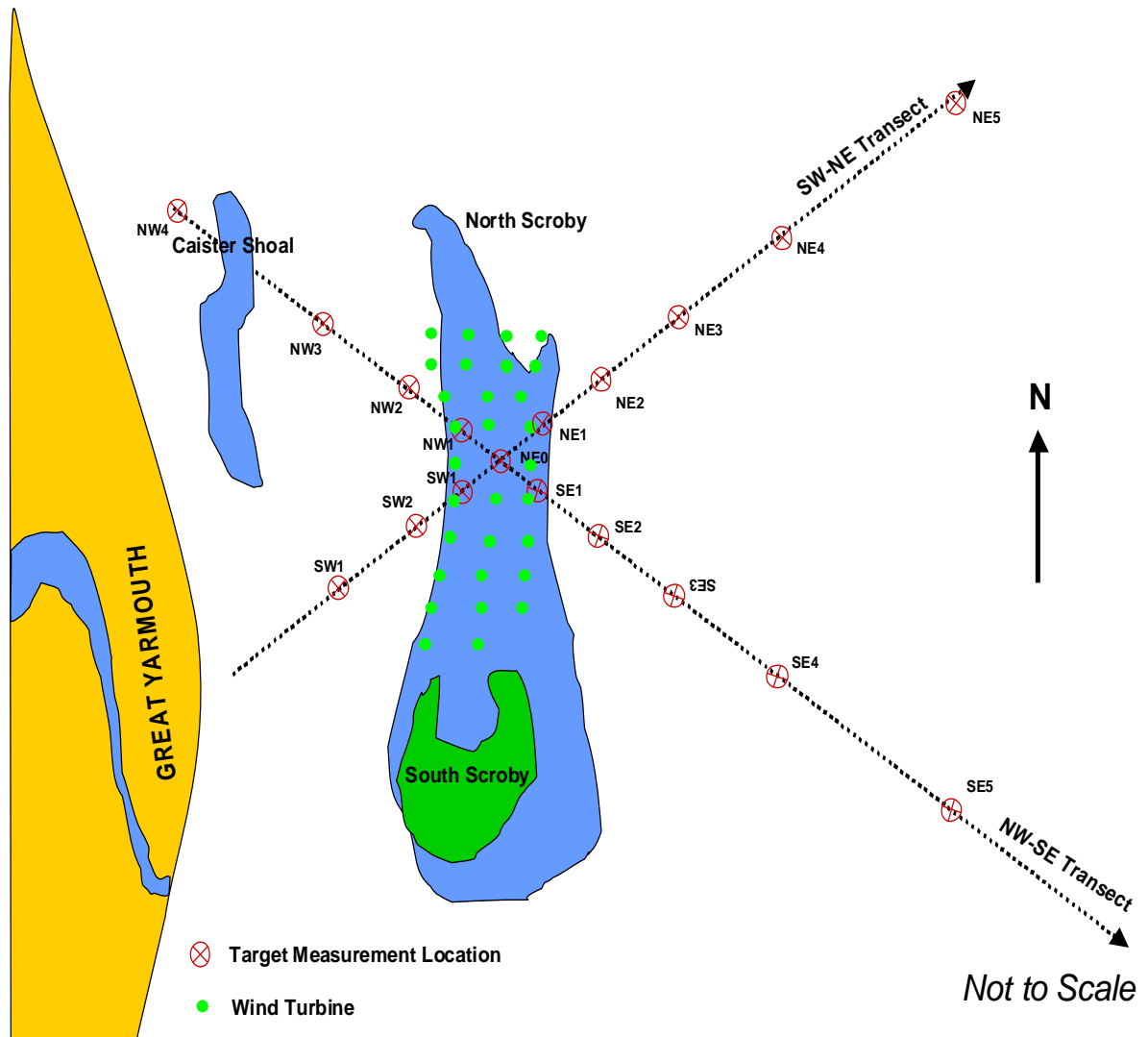

Label	Dist (m)	Bearing (True)	Position	Label	Dist (m)	Bearing (True)	Position
NE 1	250	45	52.38.775N 1.47.757E	NW 1	250	315	52.38.775N 1.47.443E
NE 2	500	45	52.38.871N 1.47.915E	NW 2	500	315	52.38.871N 1.47.285E
NE 3	1000	45	52.39.062N 1.48.229E	NW 3	1000	315	52.39.062N 1.46.971E
NE 4	2000	45	52.39.444N 1.48.859E	NW 4	2000	315	52.39.444N 1.46.341E
NE 5	4000	45	52.40.207N 1.50.118E	NW 5	4000	315	52.40.207N 1.45.082E
NE 6	8000	45	52.41.734N 1.52.637E	SE 1	250	135	52.38.585N 1.47.757E
SW 1	250	225	52.38.585N 1.47.443E	SE 2	500	135	52.38.489N 1.47.915E
SW 2	500	225	52.38.489N 1.47.285E	SE 3	1000	135	52.38.298N 1.48.229E
SW 3	1000	225	52.38.298N 1.46.971E	SE 4	2000	135	52.37.916N 1.48.858E
SW 4	2000	225	52.37.916N 1.46.342E	SE 5	4000	135	52.37.153N 1.50.116E
SW 5	4000	225	52.37.153N 1.45.084E	SE 6	8000	135	52.35.626N 1.52.631E

Figure 5. Measurement transects at Scroby Sands

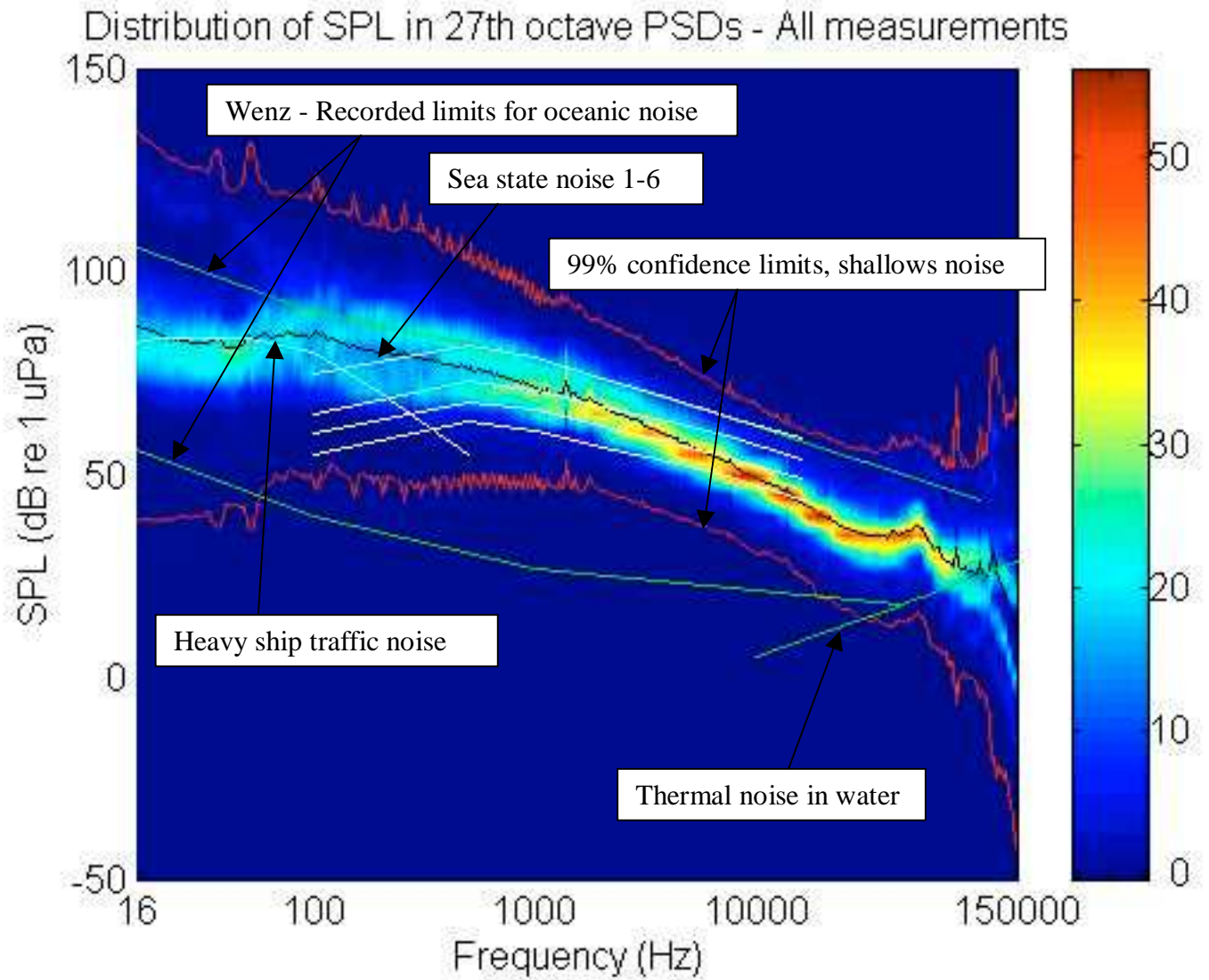

Figure 6. The measurement of background noise in shallows.

Draft:
Not for Public Information

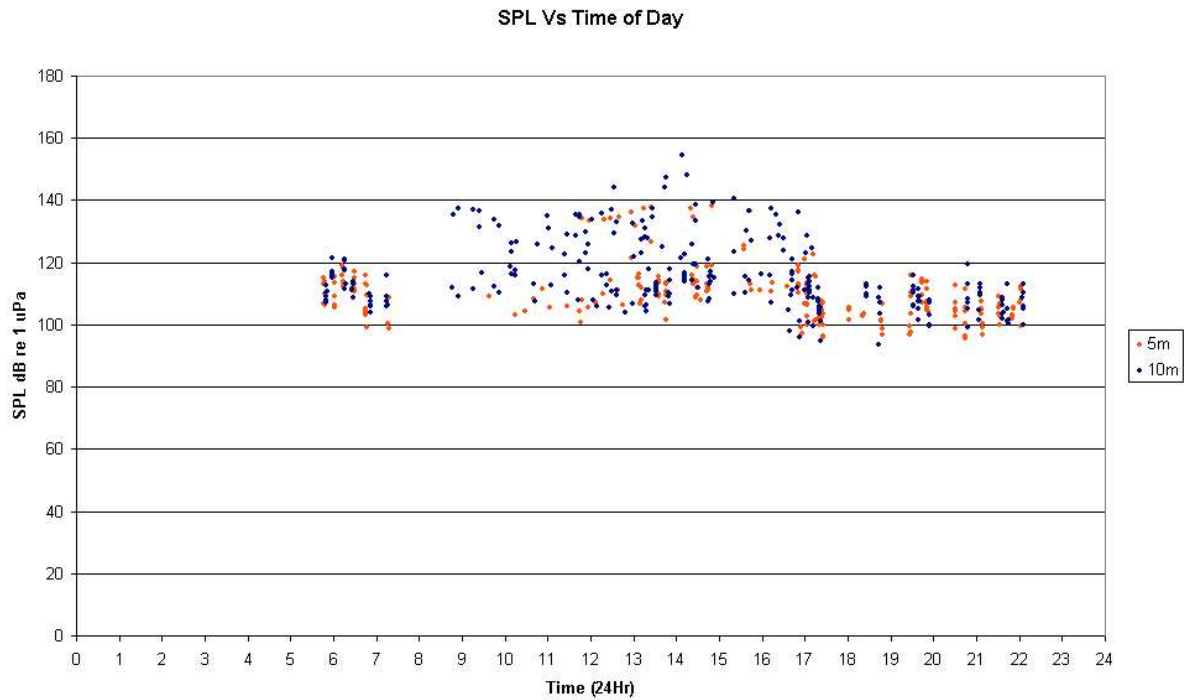

Figure 7. Noise level *versus* time of day for all measurements of background noise at North Hoyle.

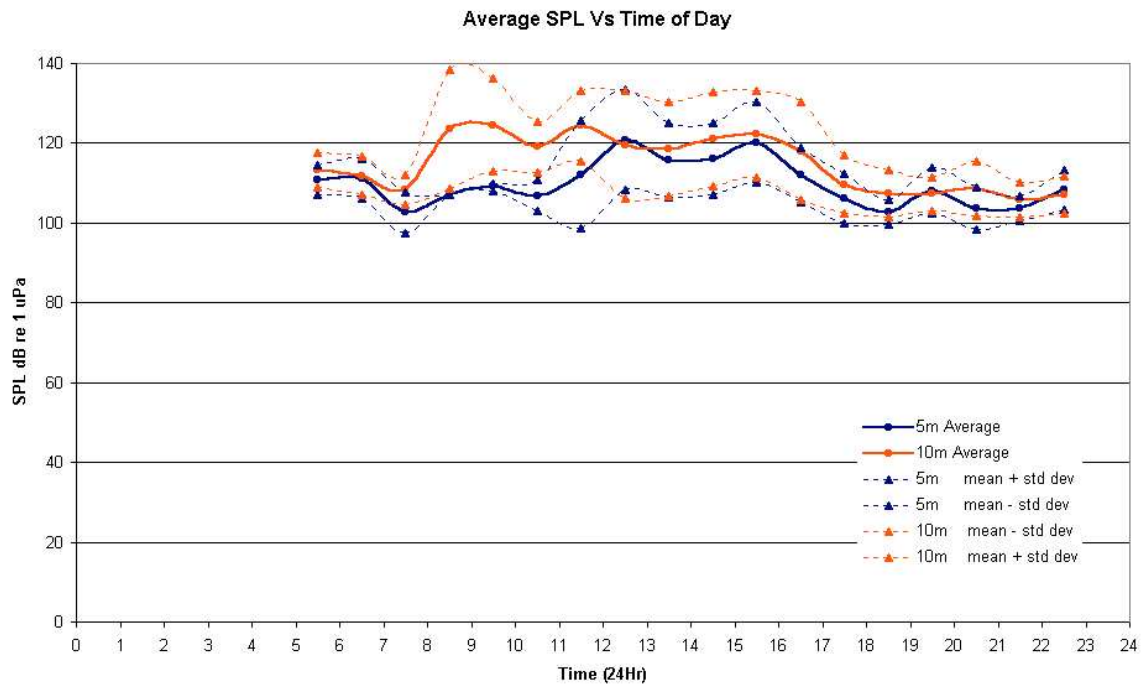

Figure 8. Averaged SPL versus time of day, with standard deviation, produced by dividing the measurements of Figure 7 into bins spanning one hour and calculating mean and standard deviation.

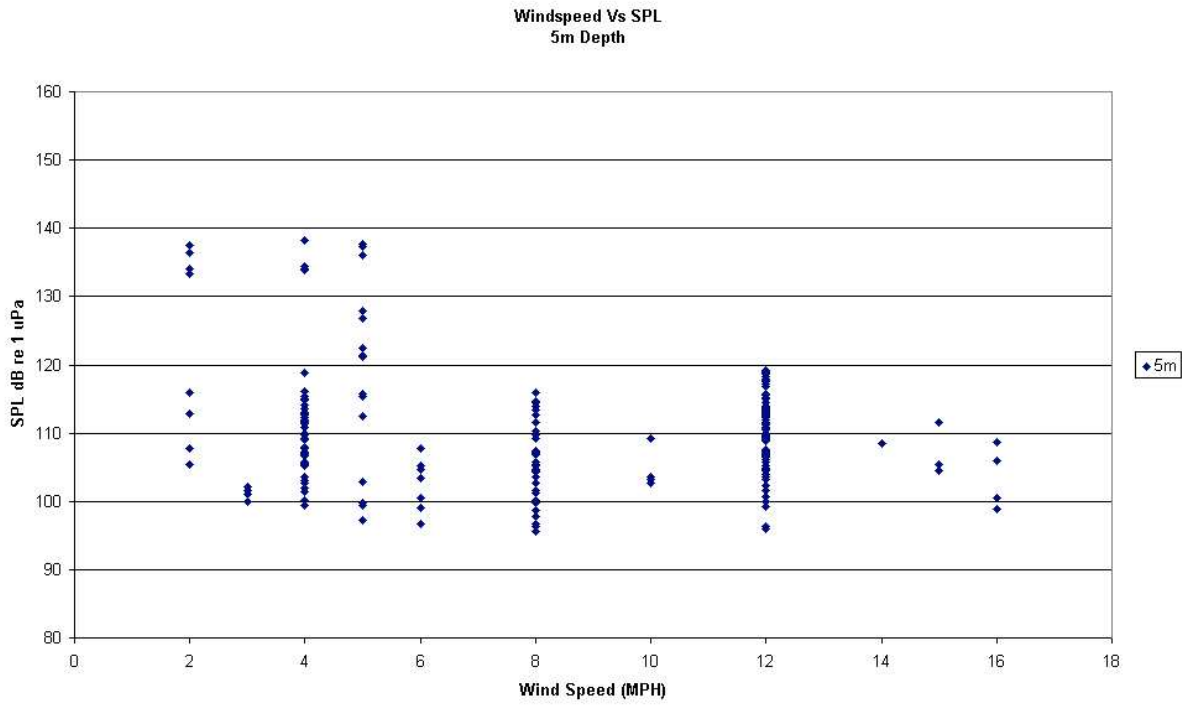

Figure 9. Wind speed Vs SPL at 5m depth for measurements of background Noise at North Hoyle.

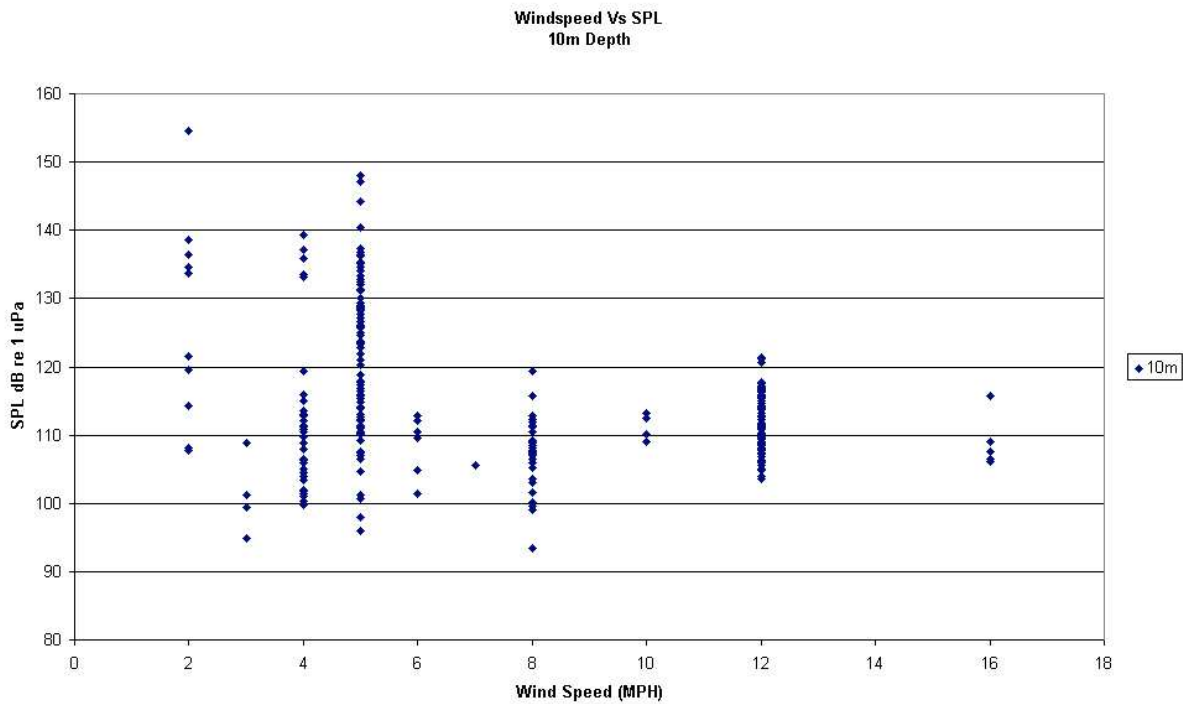

Figure 10. Wind speed Vs SPL at 10m depth for measurements of background noise at North Hoyle

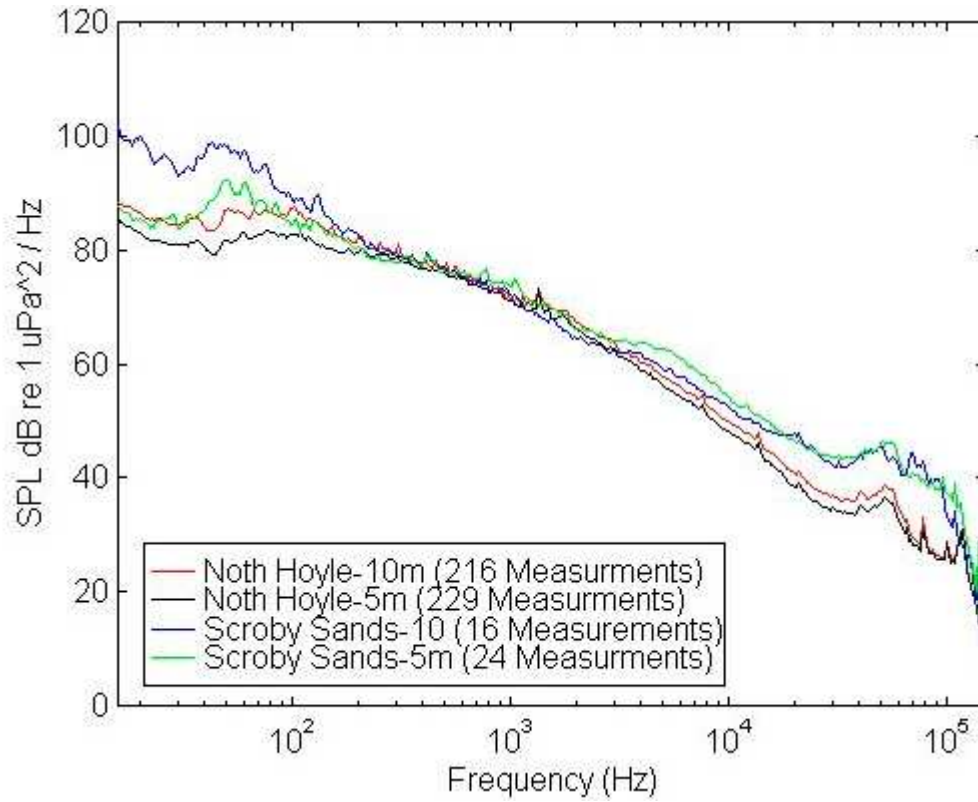

Figure 11. A comparison of the mean ambient noise levels recorded at North Hoyle with those recorded at Scroby Sands.

Draft:
Not for Public Information

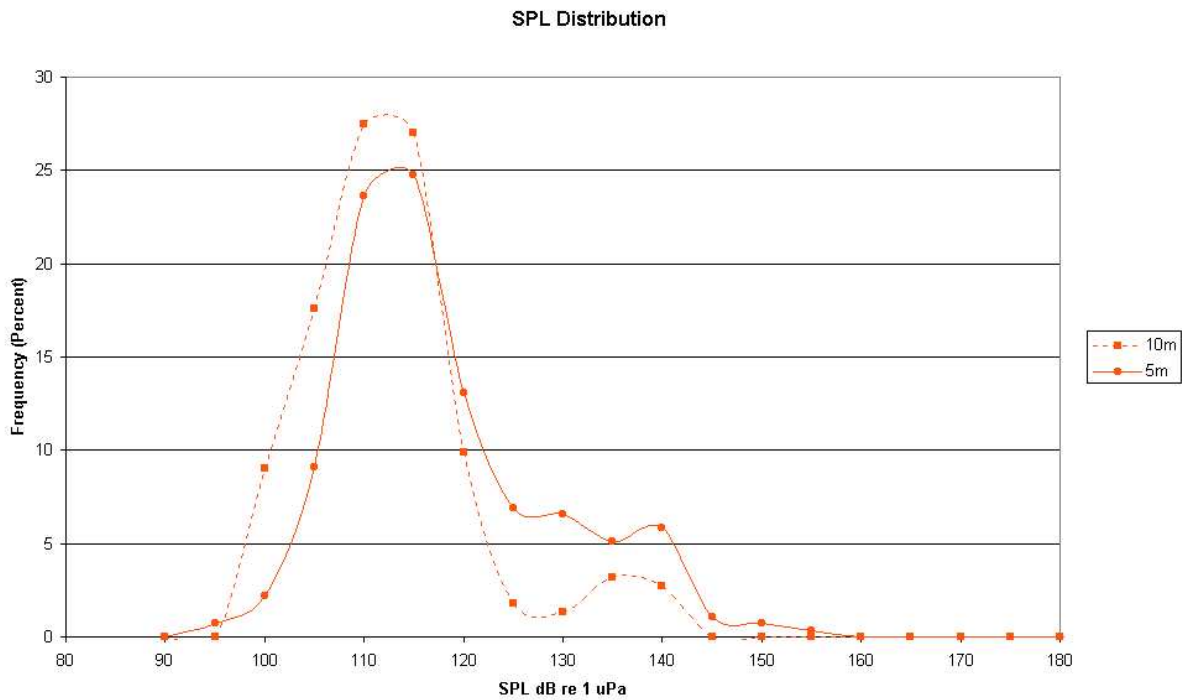

Figure 12. The distribution of SPL for all measurements of background noise at North Hoyle. 222 measurements were used to produce the 5m distribution, and 276 to produce the 10m distribution.

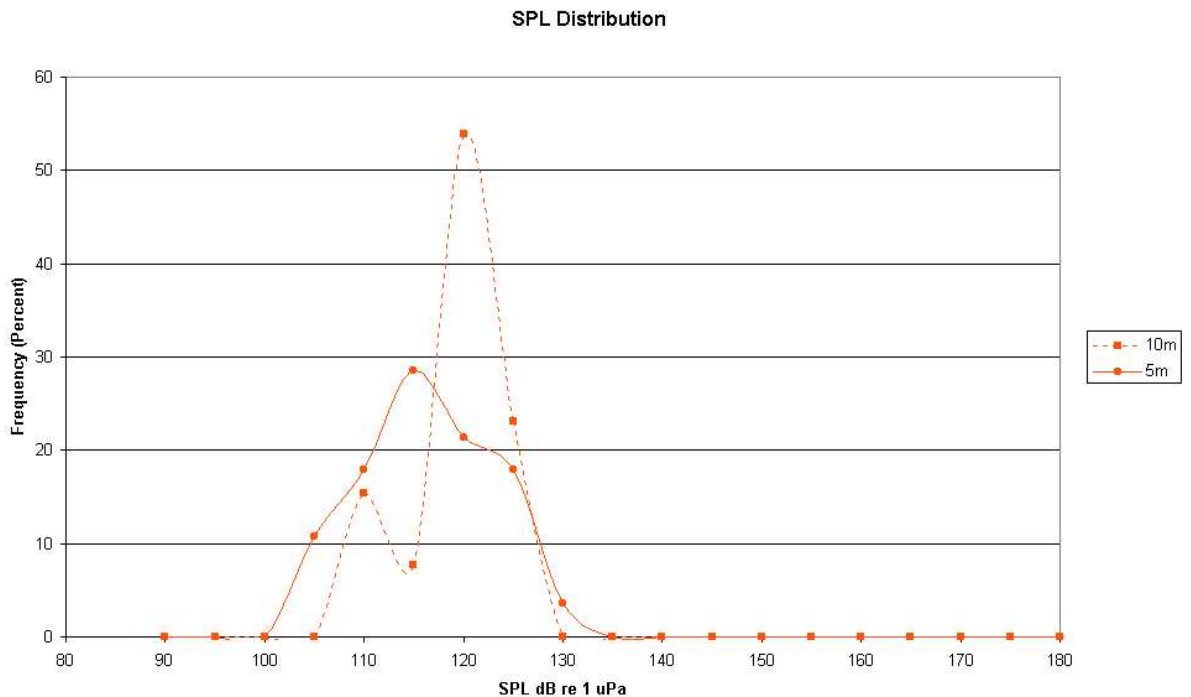

Figure 13. The distribution of SPL for all measurements of background noise at Scroby Sands. 28 measurements were used to produce the 5m distribution, and 12 measurements to produce the 10m distribution.

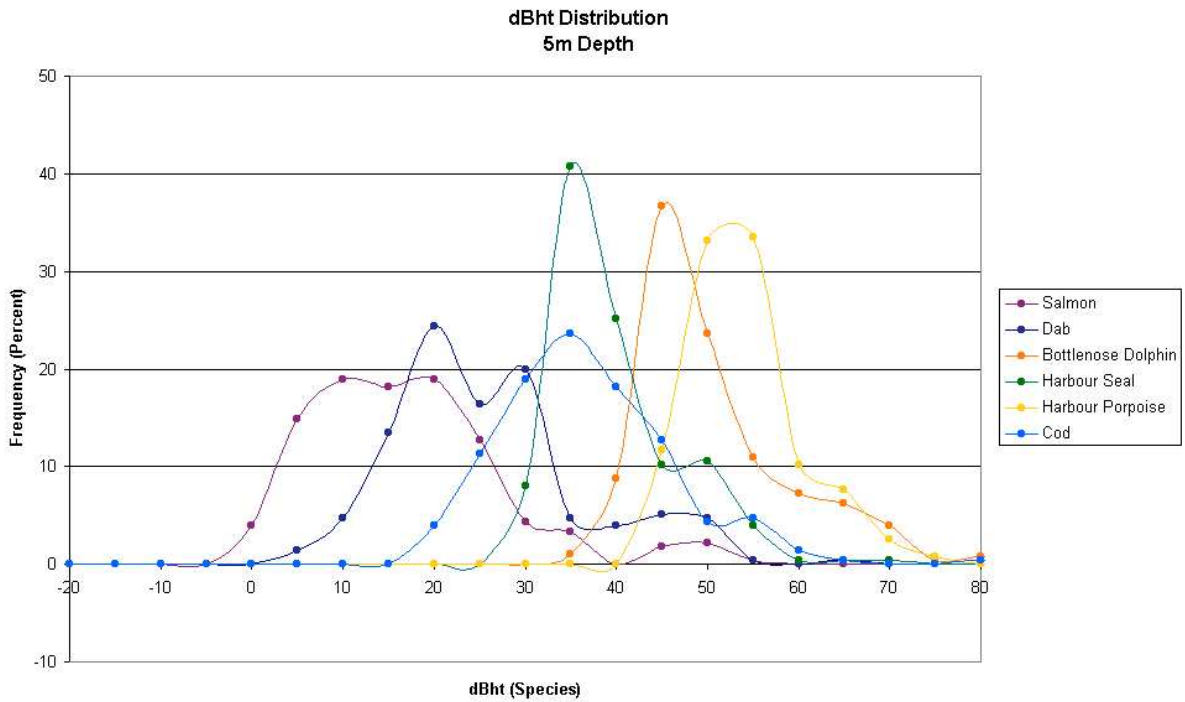

Figure 14. The distribution of dBht levels for all measurements of background noise taken at 5m depth at North Hoyle, produced from the same data set as Figure 12.

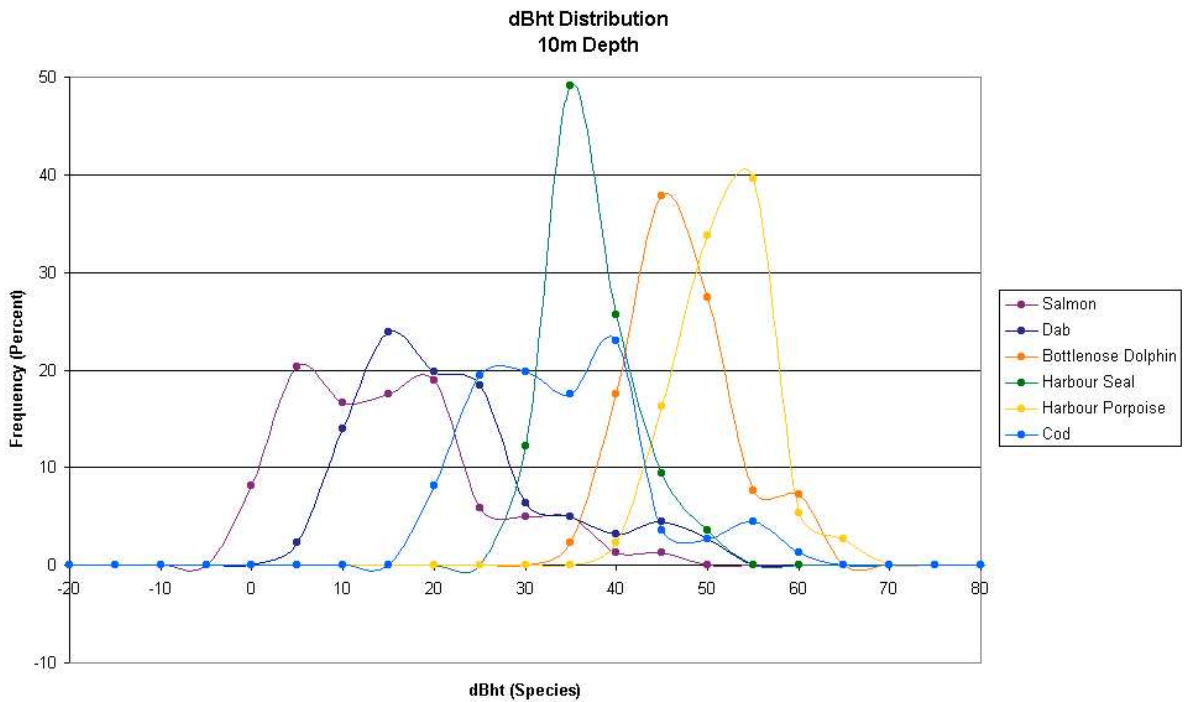

Figure 15. The distribution of dBht levels for all measurements of background noise taken at 10m depth at North Hoyle, produced from the same data set as Figure 12.

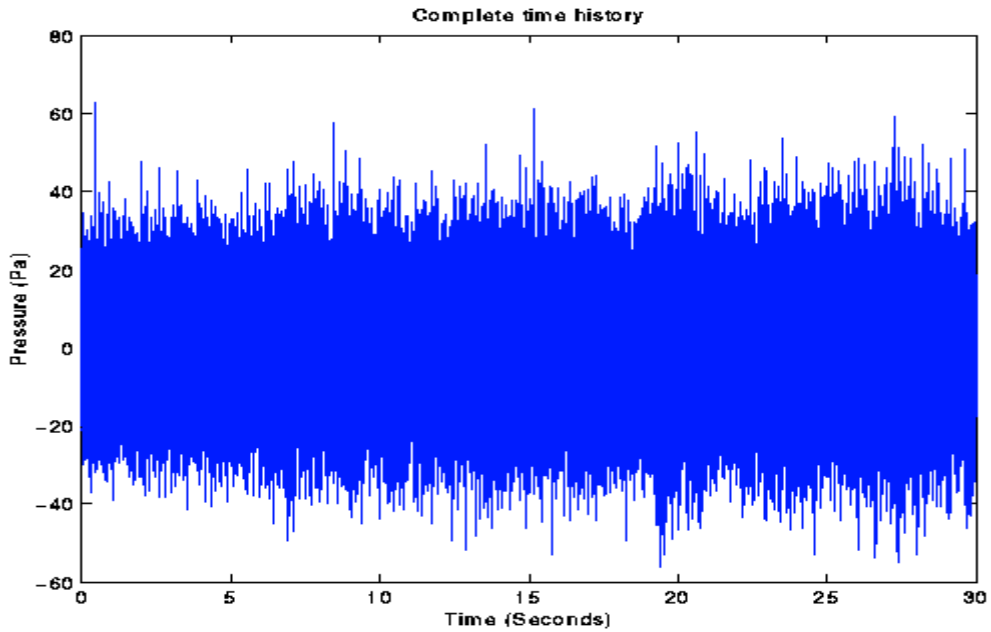

Figure 16. A typical time history of noise 500m from the Douglas Platform, with a supply vessel present and guard ship *Grampian Supporter* about 2000m away. The level is 134.7dB re 1 uPa.

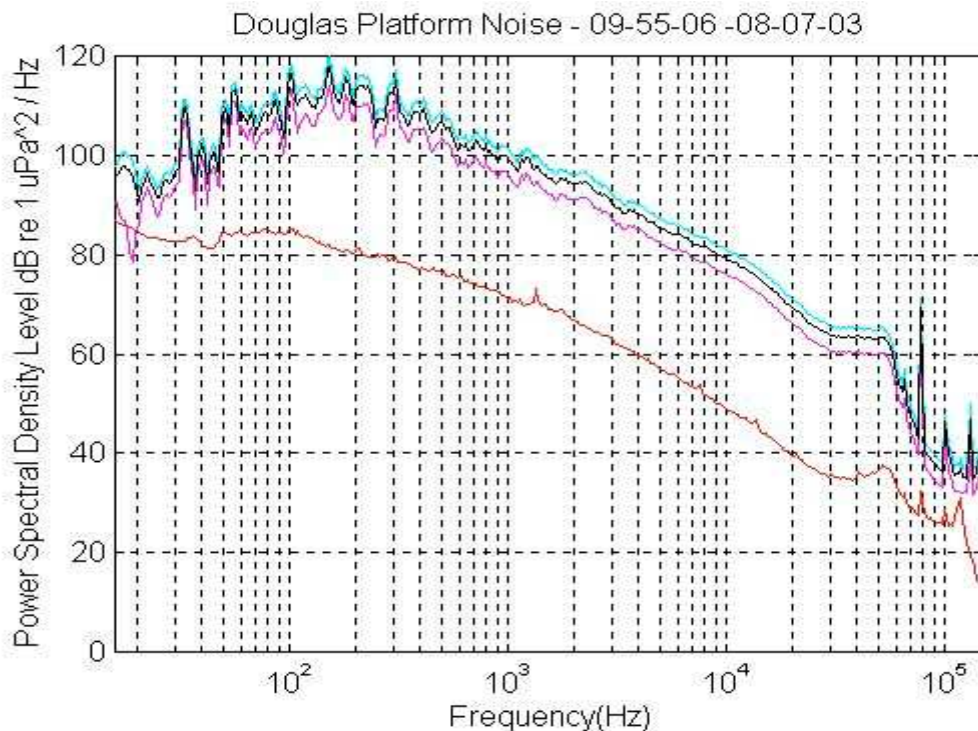

Figure 17. The power spectral density of the noise 500m from the Douglas Platform, illustrated in the preceding figure. The brown line indicates the mean background noise level.

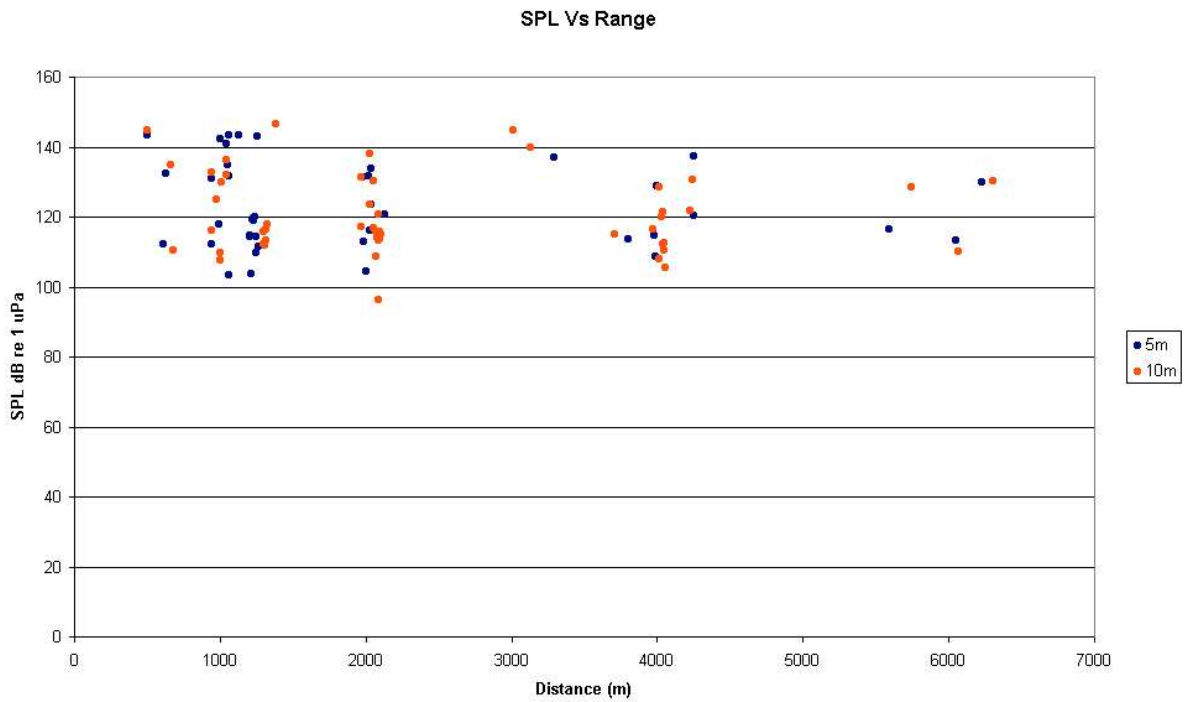

Figure 18. SPL vs Range for measurements of noise from the Douglas Platform

Draft:
Not for Public Information

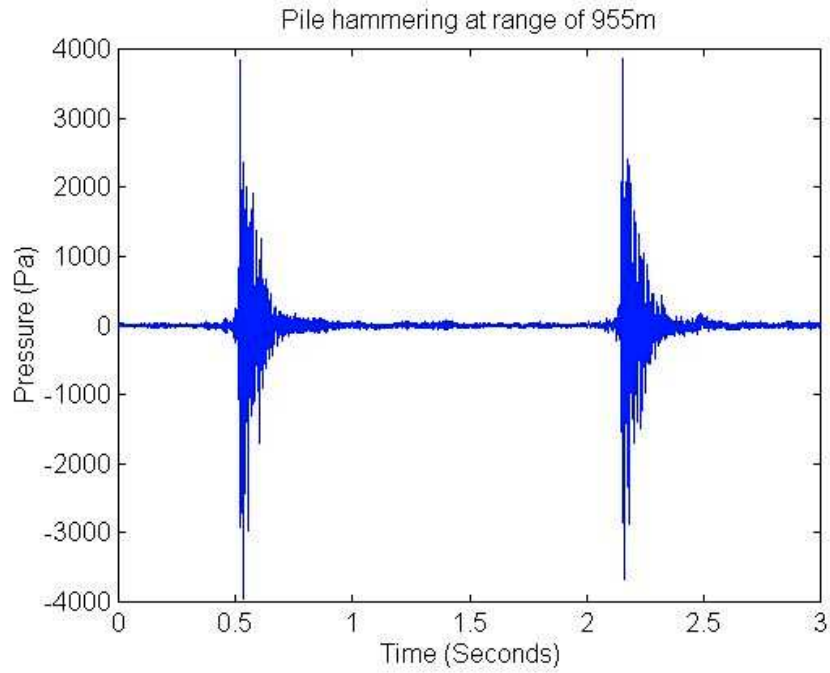

Figure 19. The time history of pile hammering recorded at 955m at North Hoyle, 5m below the water surface.

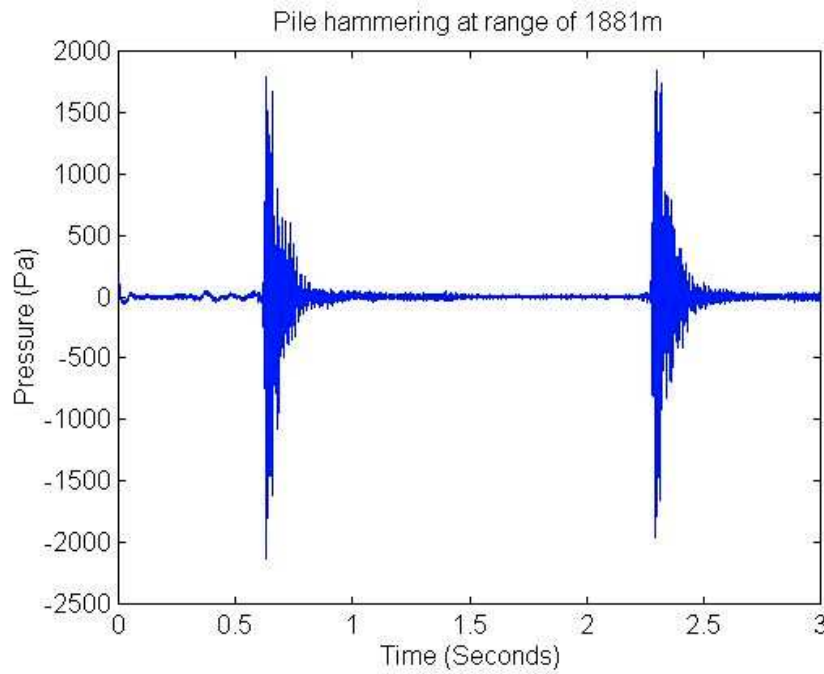

Figure 20 The time history of pile hammering recorded at 1881m at North Hoyle, 5m below the water surface.

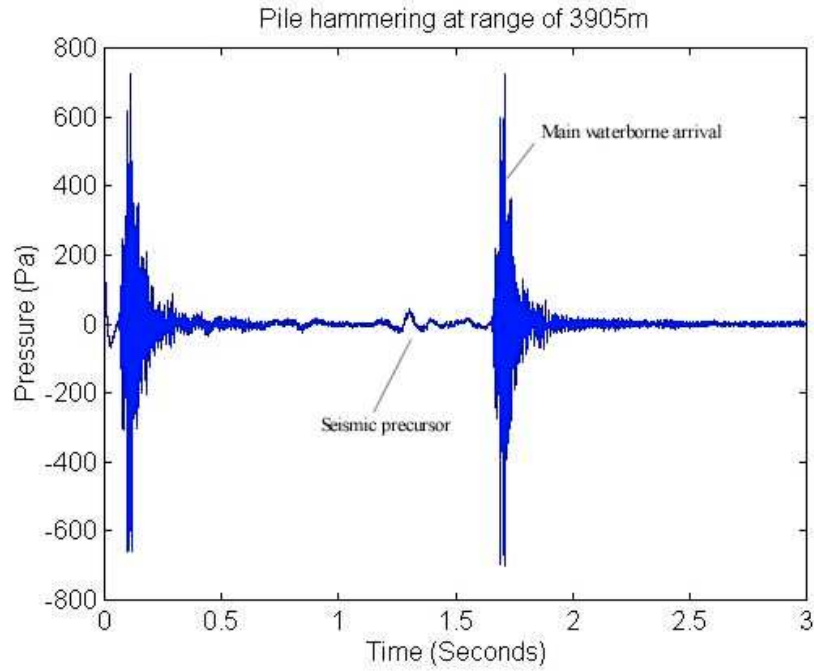

Figure 21 The time history of pile hammering recorded at 3905m at North Hoyle, 5m below the water surface.

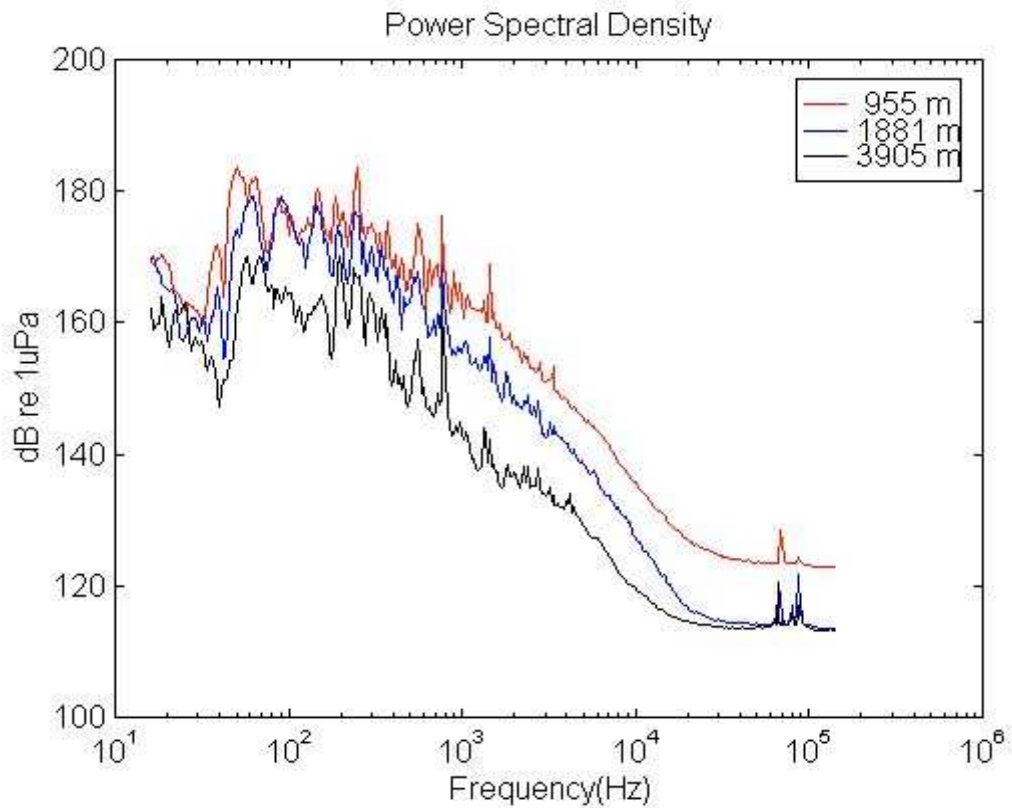

Figure 22. Energy spectra for the three measurements of pile hammering presented in figures 19, 20 and 21.

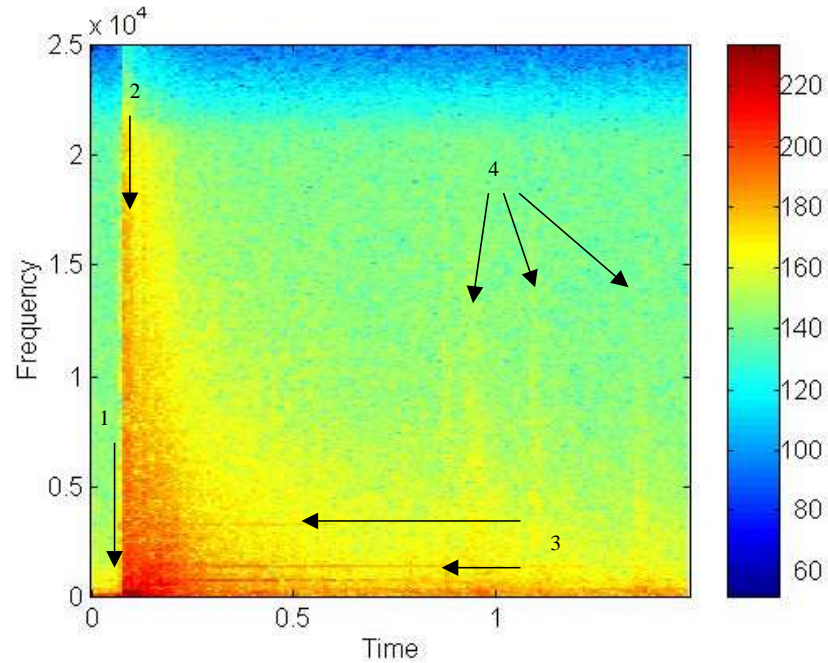

Figure 21. A spectrogram of a single impact at a range of 955 m from the source. The vertical scale represents frequencies to 25KHz, the horizontal axis represents time to 1.5 seconds. Colours represent spectral levels from 40 to 220dB re $1\mu\text{Pa}^2/\text{Hz}$.

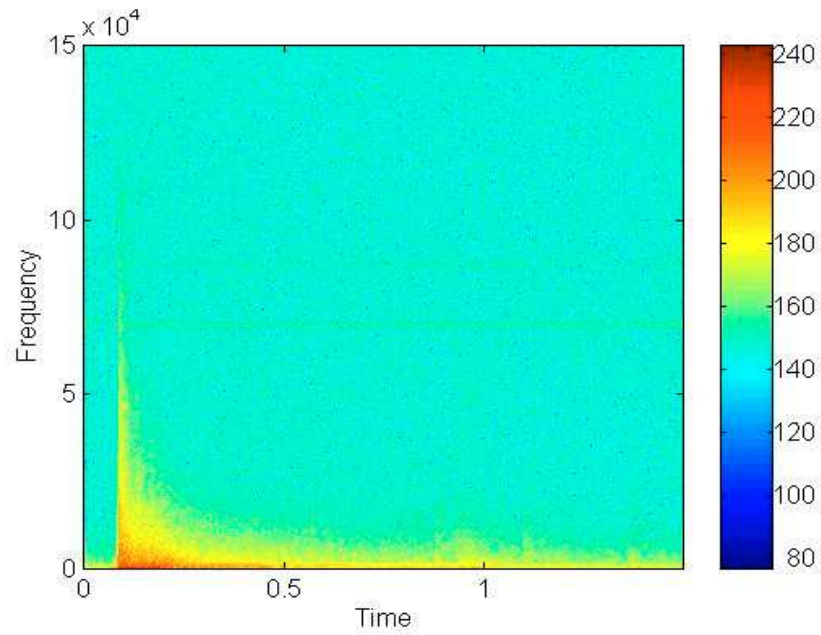

Figure 22. A spectrogram of a single impact measured at a range of 955m from the source; as preceding plot but with frequencies to 150KHz.

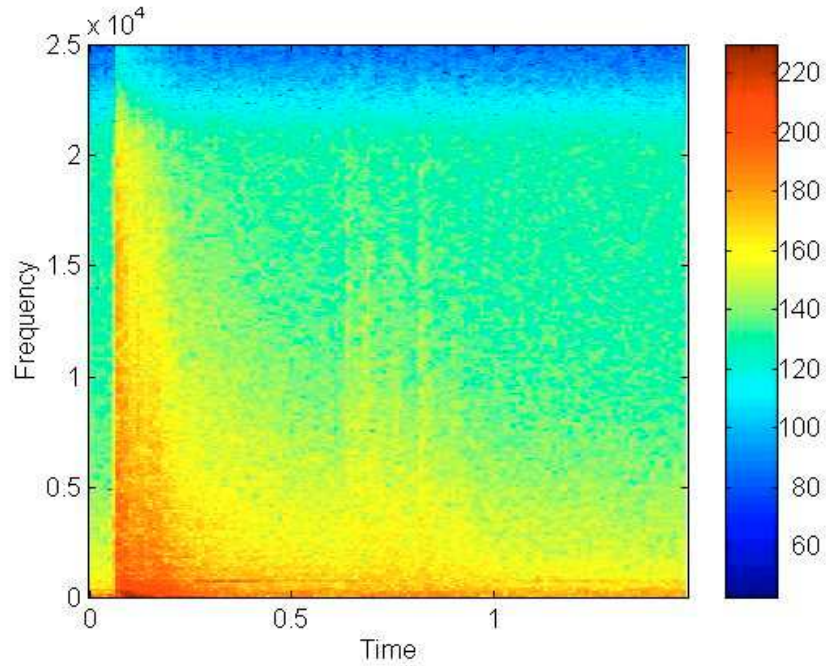

Figure 23. A spectrogram of a single impact at a range of 1881 m from the source. The vertical scale represents frequencies to 25KHz, the horizontal axis represents time to 1.5 seconds. Colours represent spectral levels from 40 to 220dB re $1\mu\text{Pa}^2/\text{Hz}$.

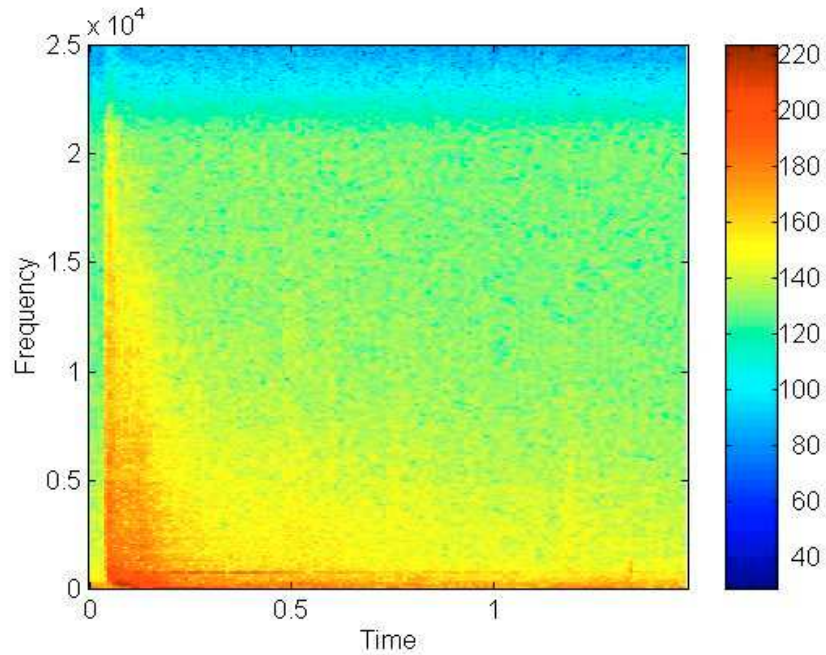

Figure 24. A spectrogram of a single impact at a range of 3905 m from the source. The vertical scale represents frequencies to 25KHz, the horizontal axis represents time to 1.5 seconds. Colours represent spectral levels from 40 to 220dB re $1\mu\text{Pa}^2/\text{Hz}$.

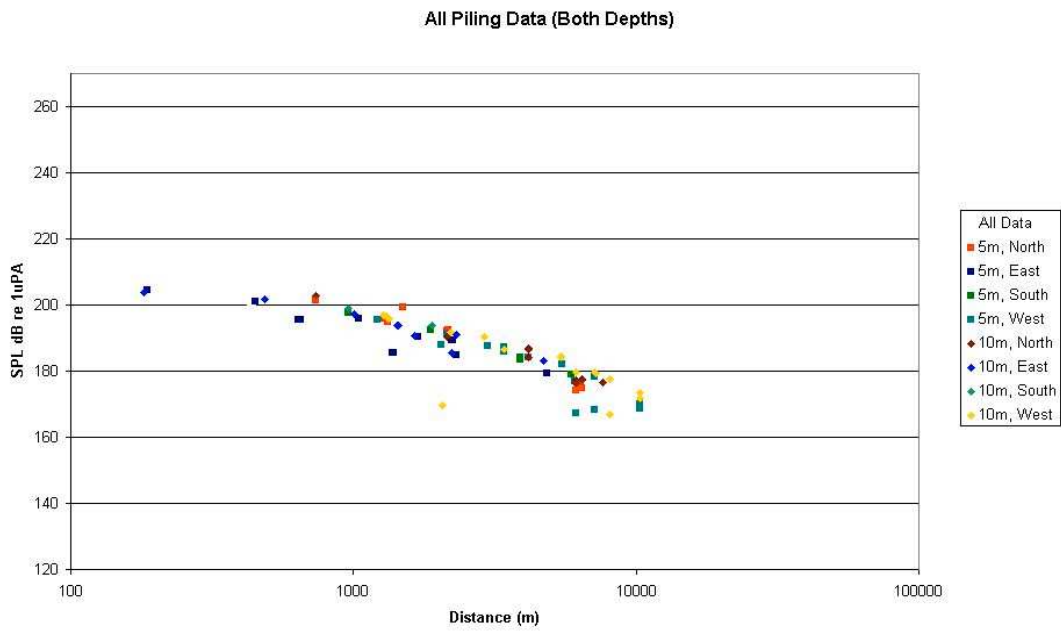

Figure 25. The peak to peak SPL of the piling plotted against range for all measurements (all transects, 5 and 10 metres depth) of pile hammering at North Hoyle.

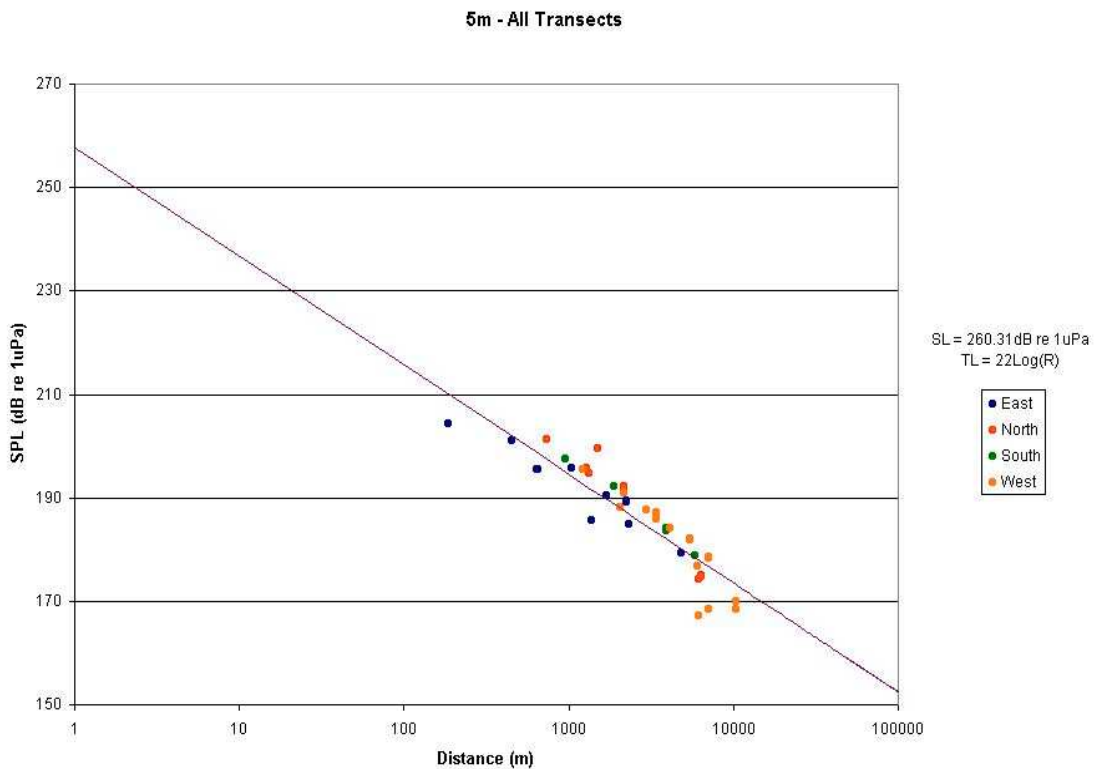

Figure 26. The peak to peak SPL of the piling plotted against range for all measurements of pile hammering at North Hoyle., at 5m depth.

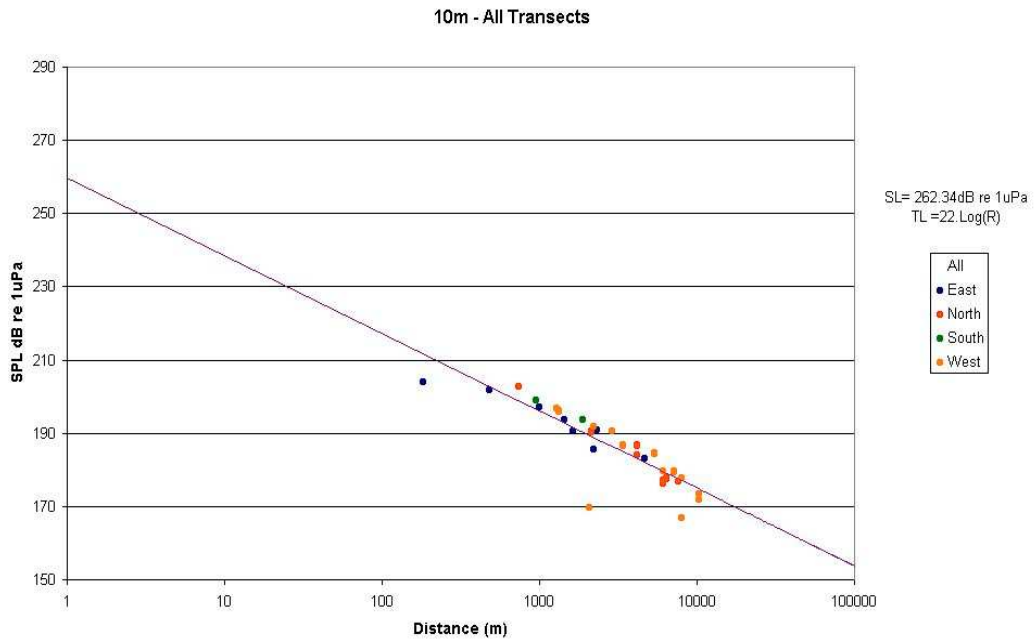

Figure 27. The peak to peak SPL of the piling plotted against range for all measurements of pile hammering at North Hoyle., at 10m depth.

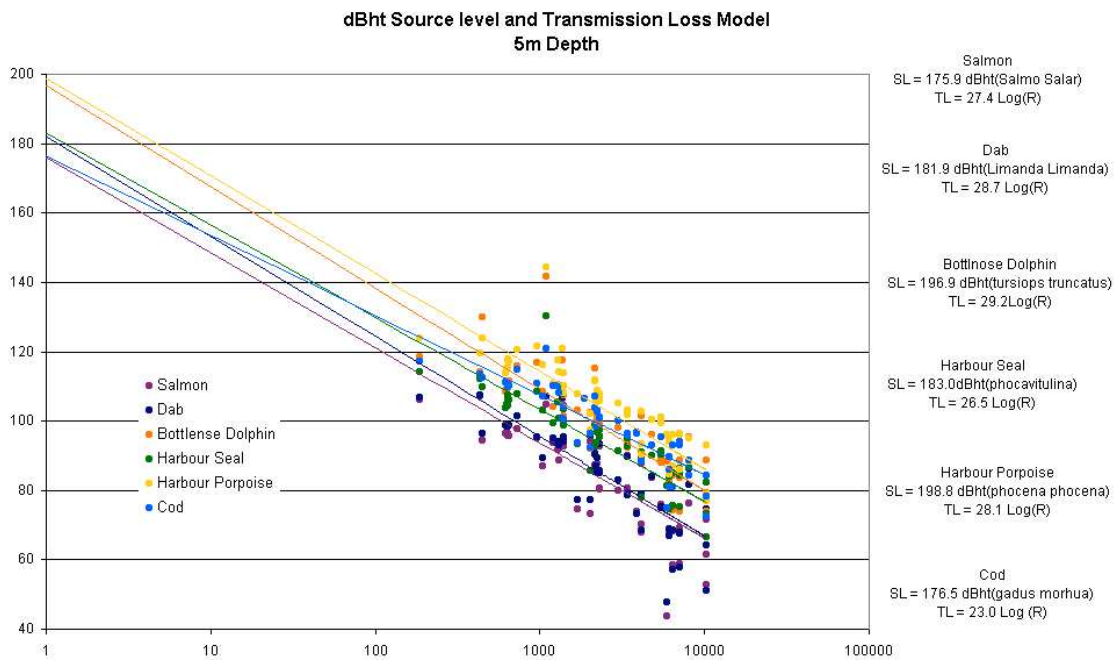

Figure 28. The dB_{ht} levels of the Pile hammering noise measurements at 5m depth, and SL and TL models for various species

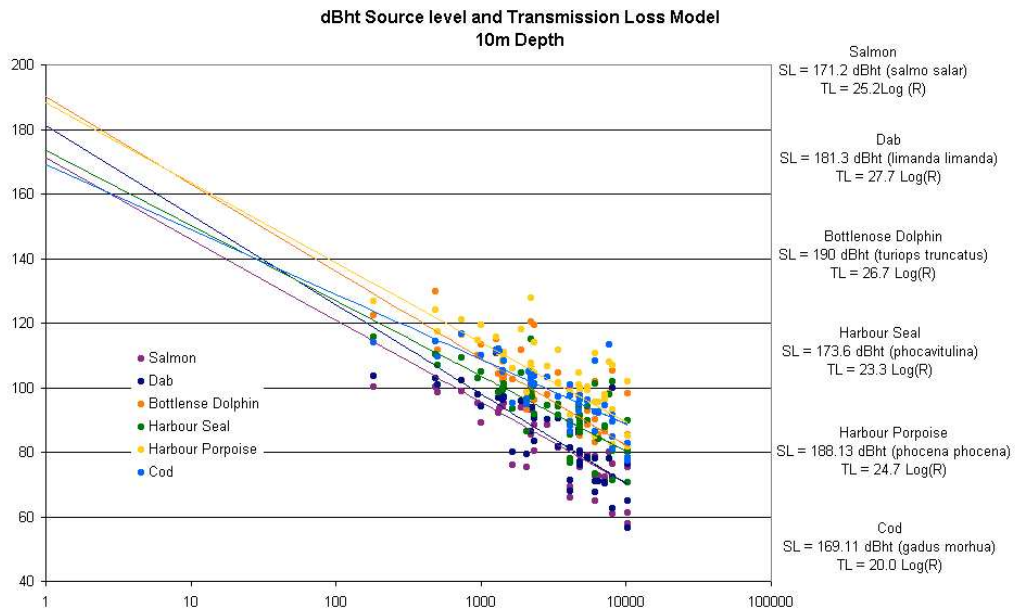

Figure 29. The dB_{ht} levels of the Pile hammering noise measurements at 10m depth, and SL and TL models for various species

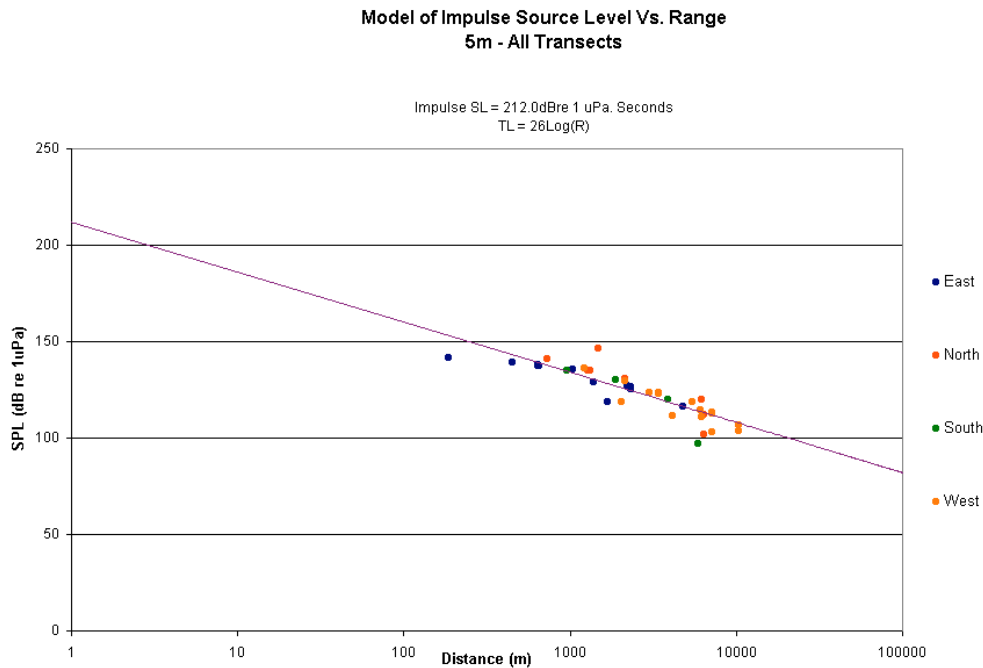

Figure 30. The measured impulse of pile hammering noise in dB re 1 µPa.s at North Hoyle at 5m depth, and Source Impulse level and Transmission Loss best fit.

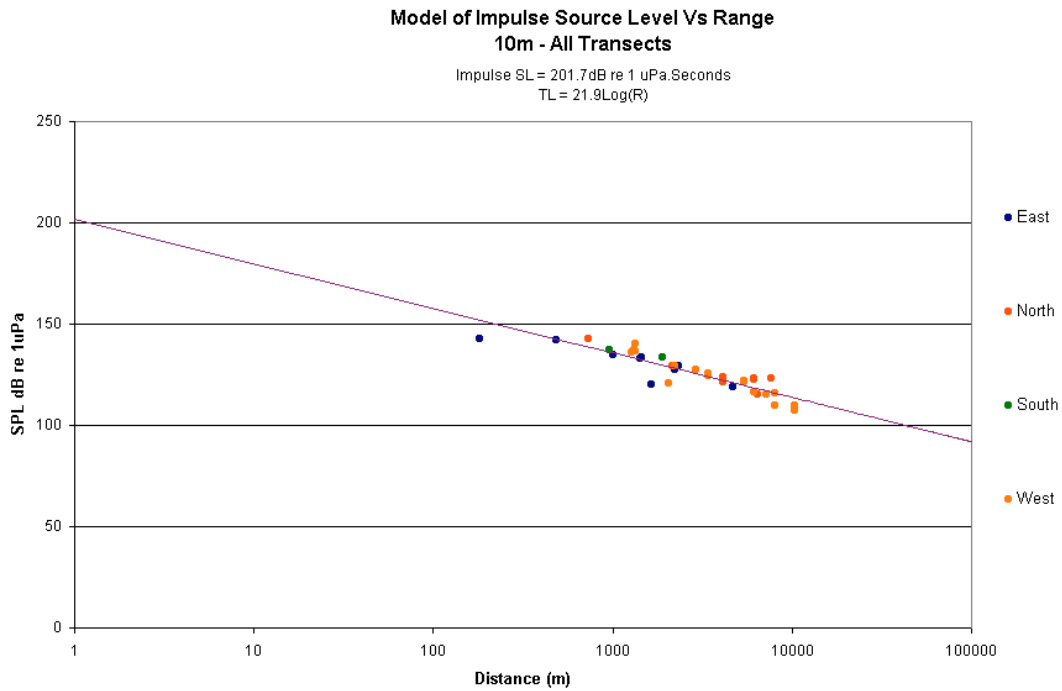

Figure 31. The measured impulse level in dB re 1 μ Pa.s of pile hammering noise at North Hoyle at 10m depth, and Source Impulse level and Transmission Loss best fit.

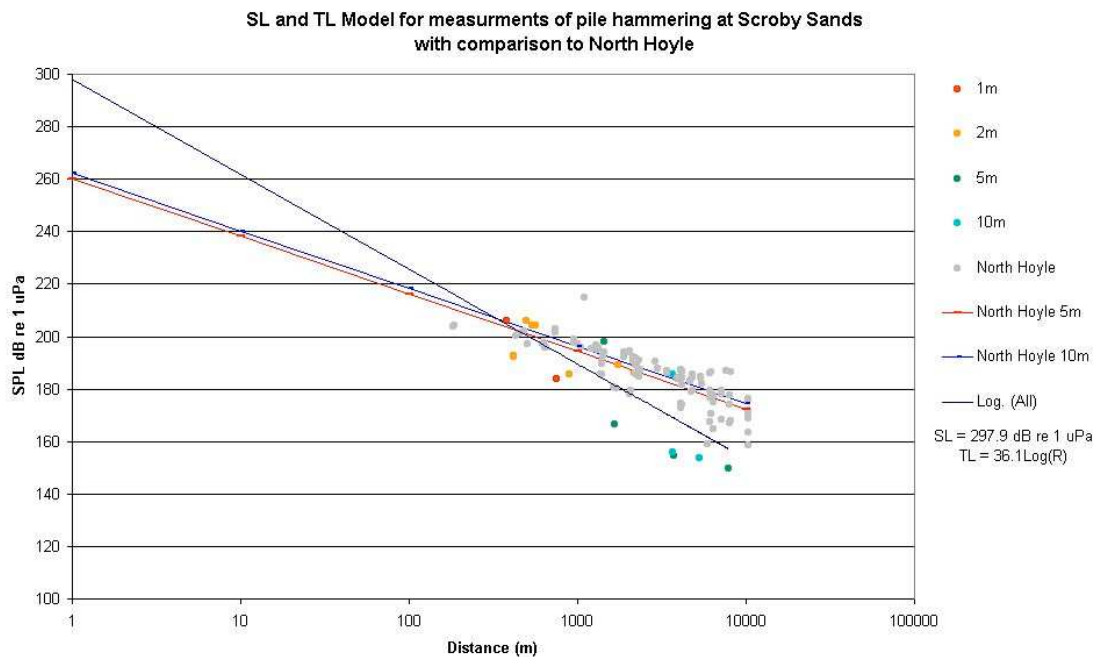

Figure 33. The peak to peak SPL of the piling plotted against range for all measurements of pile hammering at Scroby Sands.

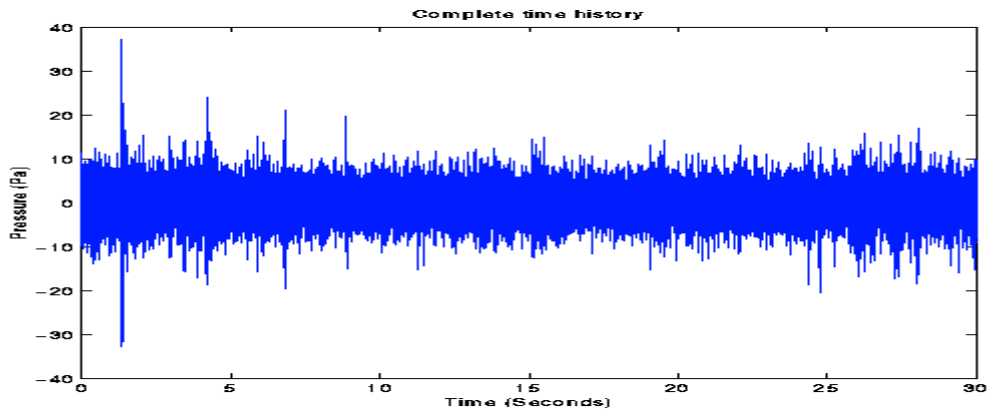

Figure 34. A typical time history of cable trenching noise, recorded at a range of 160m with the hydrophone at 2m depth.

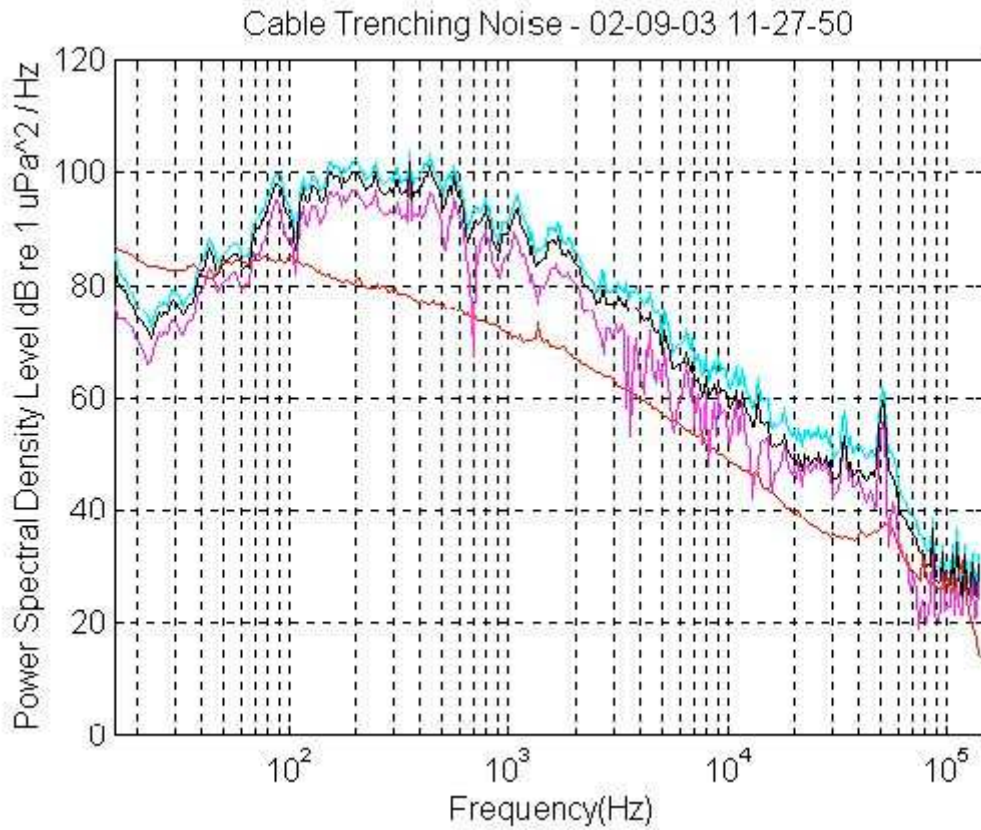

Figure 35. The power spectral density of the cable trenching noise shown in the previous figure. The brown line indicates the mean background noise level.

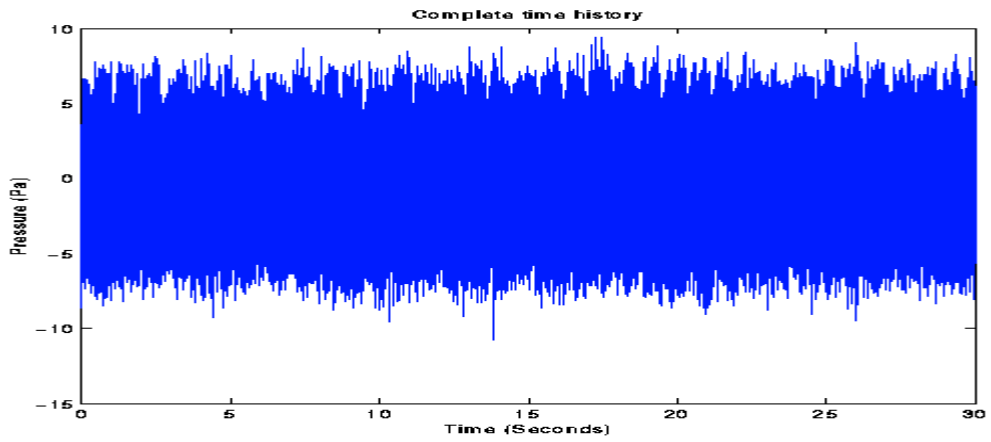

Figure 36. A typical time history of rock socket drilling noise from North Hoyle, taken at a range of 330m with the hydrophone at 10m depth

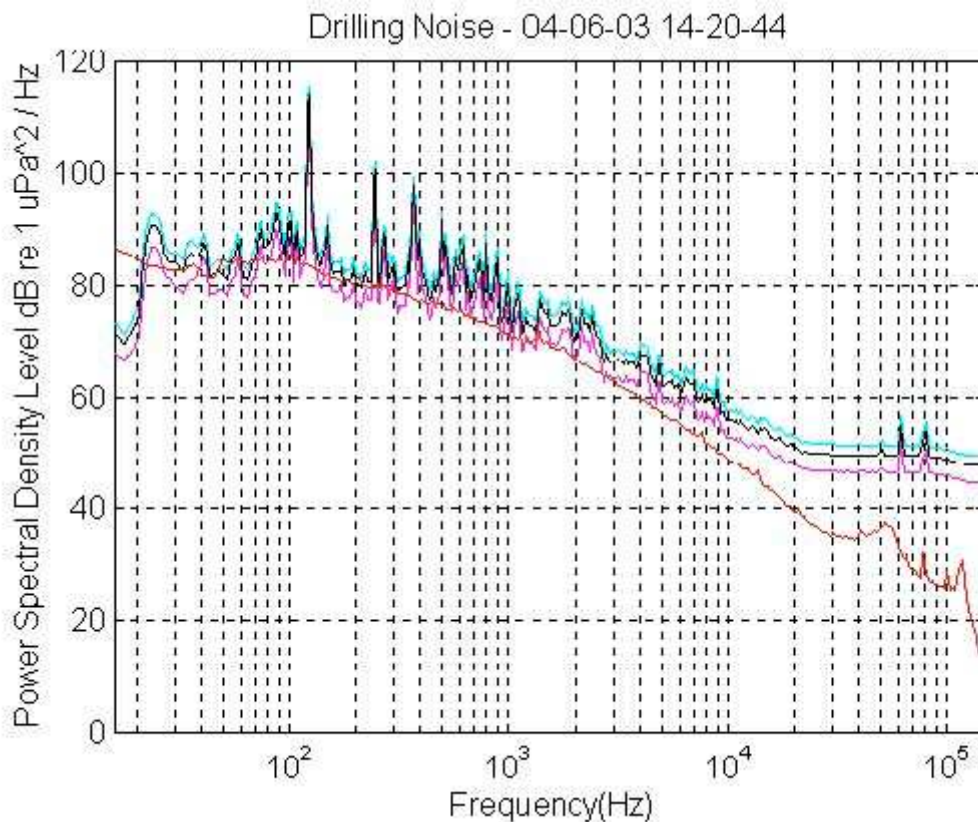

Figure 37. The power spectral density of the rock socket drilling noise from North Hoyle shown in the preceding figure. The brown line indicates the mean background noise level.

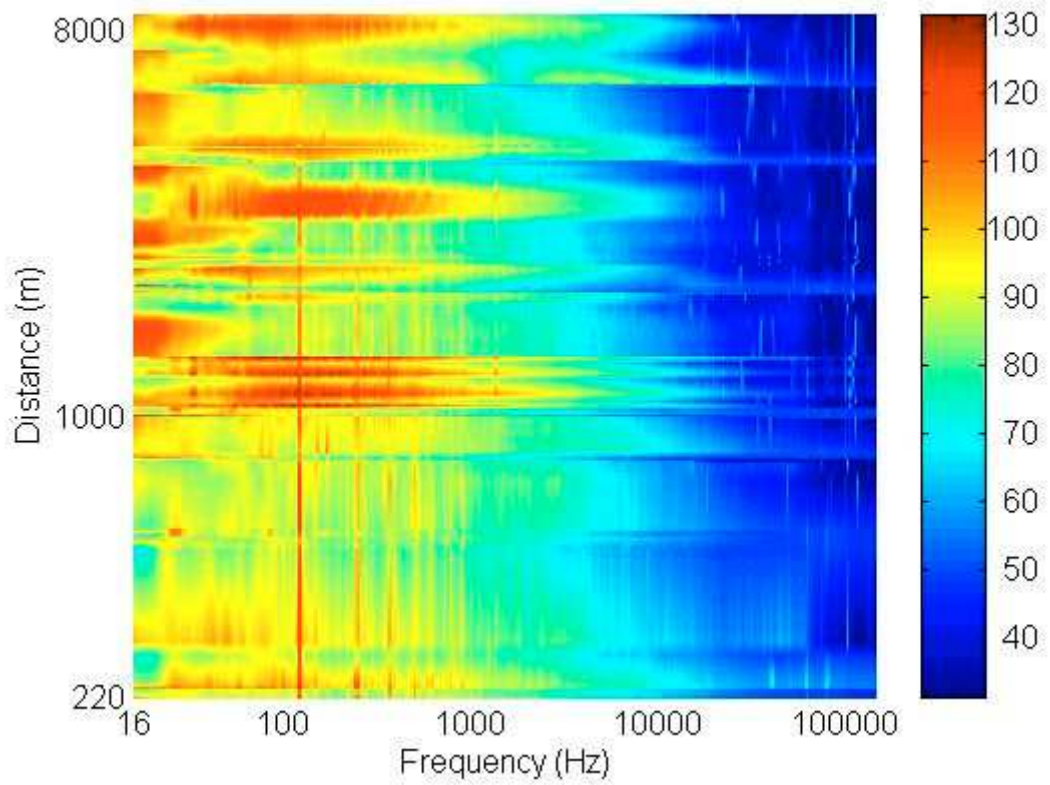

Figure 38. The power spectral density of rock socket drilling noise measurements from North Hoyle, plotted against range from the source.

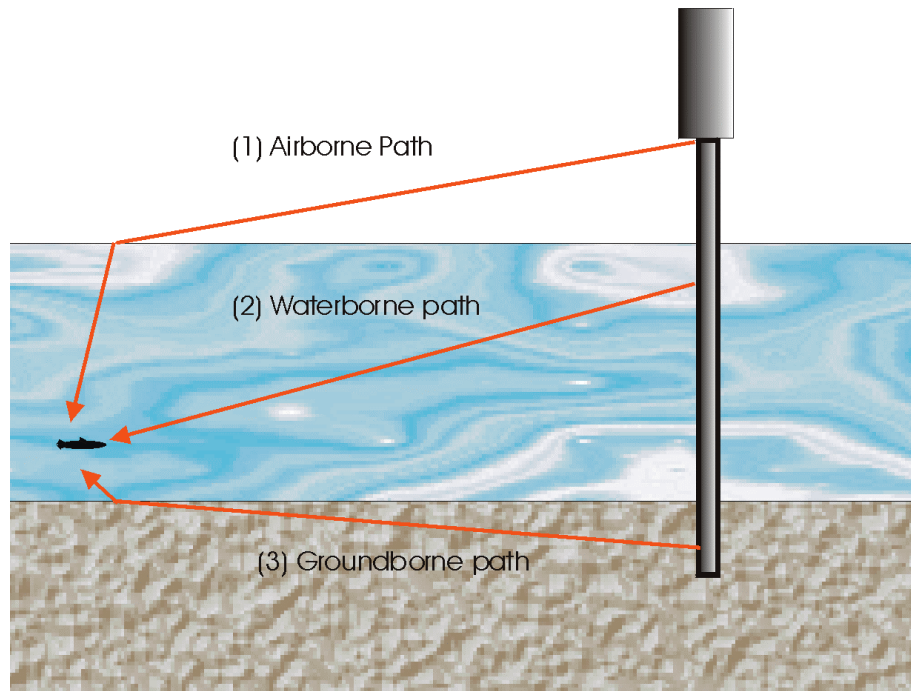

Figure 39. A sketch to illustrate the three paths by which sound can arrive from impact piling at a distant point in the water.

**Draft:
Not for Public Information**

9 References

Abbott, R. *San Francisco – Oakland Bay Bridge East Span Seismic Safety Project, Pile Installation Demonstration Project, Fisheries Impact Assessment*. Report PIDP EA 012081 on CalTrans Contract 04A014 8 (2001).

Hill, S.H. (1978). *A guide to the effects of underwater shock waves in arctic marine mammals and fish*. Pacific Mar. Sci. Rep.78-26. Inst. Ocean Sciences, Patricia Bay, Sidney, B.C. 50p.

Nedwell J R, Turnpenny A W H, Lovell J, Langworthy J, Howell D and Edwards E (2003) *The effects of underwater noise from coastal piling on salmon (Salmo salar) and brown trout (Salmo trutta)*. Subacoustech report to the Environment Agency, reference 576R0113, 12/03. Subacoustech Ltd, Chase Mill, Winchester Road, Bishop's Waltham Hampshire SO32 1AH United Kingdom.

Richardson W J, Greene C R, Malme C I and Thomson D H. *Marine mammals and noise*. London, Academic Press, (1995).

Tougaard, J., Carstensen, J., Henriksen, O.D., Skov, H. and Teilmann, J. *Short-term effects of the construction of wind turbines on harbour porpoises at Horns Reef*. Technical report to TechWise A/S. HME/362-02662, Hedeselskabet, Roskilde (2003).

Turnpenny, A W H and Nedwell, J R. *The effects on marine fish, diving mammals and birds of underwater sound generated by seismic surveys*. Report to the UK Offshore Operators Association No FRR 089/94 (1994).

Wenz, G *Acoustic ambient noise in the ocean; spectra and sources*. Journal of the Acoustical Society of America N34, pp 1936, (1962).

Yelverton J.T., Richmond, D.R., Hicks, W., Sanders, K. and Fletcher, E.R *Safe distances from underwater explosions for mammals and birds*. DNA 3114T, Rep. From Lovelace Foundation for Medical Educ. And Res., Albuquerque, NM, for Defense Nuclear Agency, Washington, DC, 67 p, NTIS AD-766952 (1972).

Draft:
Not for Public Information

10 Appendix A - Measuring noise.

Units for measuring noise.

The fundamental unit of sound pressure is the Newton per square metre or Pascal.

Impulsive noise sources.

Impulsive noise sources may be categorised as those having finite duration such as piling and underwater blast. Impulsive noise sources can be characterised by two key parameters, peak pressure and impulse.

Peak pressure.

The peak pressure of an impulsive source P_{\max} is the maximum level of pressure from an impulsive noise source. This is usually at the initial peak of the waveform and is easily read from a recording of a time history. The peak pressure of an impulsive source is the parameter normally used as the measure of its strength in respect causing physical injury to animals.

Impulse.

The impulse I is defined as the integral of pressure over time and is given by

$$I = \int_0^{\infty} P(t) \delta t$$

where I is the impulse in Pascal-seconds (Pa.s), $P(t)$ is the acoustic pressure in Pa of the sound wave at time t and t is time. Impulse may be thought of as the average pressure of the wave multiplied by its duration. The importance of impulse is that in many cases a wave acting for a given time will have the same effect as one of twice the pressure acting for half the time. The impulse of both these waves would be the same. Impulse is the parameter an impulsive source normally used as the measure of its strength in respect of environmental effects.

Non-impulsive noise sources.

Draft:

Non-impulsive noise sources may be categorised as having largely constant variation in amplitude with time; examples would include noise from a propeller or engine. Non-impulsive sounds are categorised using the root mean square (RMS) pressure level averaged over time.

RMS pressure.

Time averaged RMS pressure is defined by

$$P_{RMS}(t) = \sqrt{\frac{1}{T} \int_0^T P^2(t).dt}$$

Where the period T must be large compared with the period of the lowest frequency component in the signal. In this report the time averaging period used has been 1 second.

Sound Pressure Level

In expressing underwater acoustic phenomena it is convenient to express the sound pressure (either peak or RMS as described above) through the use of a logarithmic scale termed the *Sound Pressure Level*.

There are two reasons for this.

First, there is a very wide range of sound pressures measured underwater, from around 0.0000001 Pascal in quiet sea to say 10000000 Pascal for an explosive blast. The use of a logarithmic scale compresses the range so that it can be easily described (in this example, from 0 dB to 260 dB re 1 μ Pa).

Second, many of the mechanisms affecting sound underwater cause loss of sound at a constant rate when it is expressed on the dB scale.

The Sound Pressure Level, or SPL, is defined as:–

$$SPL = 20 \log \left(\frac{P}{P_{ref}} \right)$$

where P is the sound pressure to be expressed on the scale and Pref is the reference pressure, which for underwater applications is 1 μ Pa.

All of the levels of sound presented in this report are expressed in decibels referenced to 1 microPascal, that is, as dB re 1 μ Pa.

Source Level and Transmission Loss.

In order to provide an objective and quantitative assessment of degree of any environmental effect it is necessary to estimate the sound level as a function of range. To estimate the sound level as a function of the distance from the source, and hence the range within which there may be an effect of the sound, it is necessary to know the level of sound generated by the source and the rate at which the sound decays as it propagates away from the source. These two parameters are:

- 1 the Source Level (i.e. level of sound) generated by the source, and
- 2 the Transmission Loss, that is, the rate at which sound from the source is attenuated as it propagates.

These two parameters allow the sound level at all points in the water to be specified, and in the current state of knowledge are best measured at sea, although it is in principle possible to estimate the transmission loss using numerical models. Usually this data has to be extrapolated to situations other than those in which the noise was measured; the usual method of modelling the level is from the expression

$$SPL = SL - N \log R - \alpha R.$$

If the level of sound at which a given effect of the sound is known, an estimate may be made of the range within which there will be an effect.

Source level.

The source level of a source is defined as the "effective" level of sound at a nominal distance of one metre, expressed in dB re 1 μ Pa. However, the assumptions behind this simple definition warrant careful explanation.

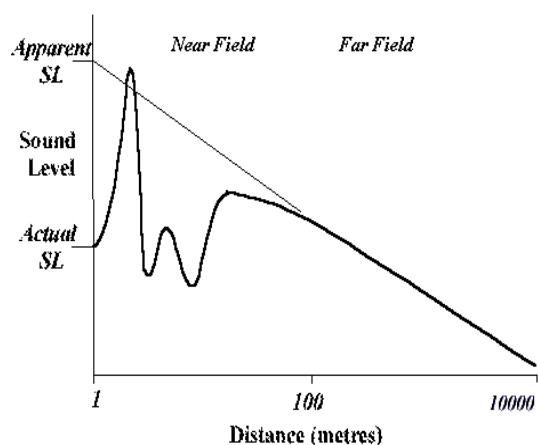

Figure A.1. Source level and near field effects.

It is normal to measure the sound pressure in the far field, at sufficient distance from the transducer that the field has "settled down", and to use this pressure to estimate the *apparent* (or *effective*) level at a nominal one metre from the source. The apparent level may bear no relation to the actual level.

A measurement of the apparent level can be accomplished by assuming inverse dependence of pressure on the range, R , from the noise source, or by extrapolating the far field pressure. For instance, if measurements were made in the range 100 metres to 10000 metres in the example in the diagram, the apparent level would, as illustrated by the extrapolation, be much higher than the actual level.

There is in general no reliable way of predicting the noise level from sources of man-made noise, and hence it is normal to directly measure the source level where a requirement exists to estimate far-field levels.

Transmission loss.

Transmission in the ocean has probably been the subject of more interest than any other topic in underwater communication, since it is the parameter that is the least predictable and the least capable of being influenced.

The sound from a source can travel through the water both directly and by means of multiple bounces between the surface and seabed. Sound may also travel sideways through the rocks of the seabed, re-emerging back into the water at a distance. Refraction and absorption further distorts the impulse, leading to a complex wave arriving at a distant point which may bear little resemblance to the wave in the vicinity of the source. Finally, sound may be carried with little loss to great distance by being trapped in sound channels.

Predicting the level of sound from a source is therefore extremely difficult, and use is generally made of simple models or empirical data based on measurements for its estimation.

Estimates of transmission loss.

Transmission loss, or TL, is a measure of the rate at which sound energy is lost, and is defined as:

$$TL = 20 \log \left(\frac{P_0}{P_R} \right)$$

where P_0 is the pressure at a point at one metre from the source, and P_R is the pressure at range R away from it.

The usual method of modelling the transmission loss is from the expression:

$$TL = N \log R - \alpha R$$

where R is the range from the source in metres and N and α are coefficients relating to geometric spreading of the sound and absorption of the sound respectively. High values of N and α relate to rapid attenuation of the sound and limited area of environmental effect, and low values to the converse. For ranges of less than 10 km the linear attenuation term α can in general be ignored; a value of N of 20, corresponding to spherical spreading of the sound according to the inverse square law, is often assumed.

The dBht (*Species*) scale for perceived noise levels

We use the term “perception scale” to describe a scale for measuring sound which incorporates the sensitivity of the species as a function of frequency to the sound, and hence allows its “loudness” for that species to be judged.

The dB(A) or human perception scale

The dB(A) is well established as a means by which the behavioural effects of sound on the human may be judged. We propose the extension of the principle on which it is related to marine mammals and fish.

Implementation of the dB(A)

The human ear is most sensitive to sound at frequencies of the order of 1 to 4 kHz, and hence these frequencies are of greatest importance in determining the physical and psychological effects of sound for humans. At lower or higher frequencies the ear is much less sensitive, and humans are hence more tolerant of these frequencies. To reflect the importance of this effect a scale of sound (the dB(A)) has been developed which allows for the frequency response of the human ear. In order to estimate the physical and subjective effects of sound using this scale, the sound signal is first weighted by being passed through a filter which approximately mimics the effectiveness of human hearing. The sound is measured after undergoing this process. The level of sound that results is well established as being related to its effects on humans. The dB(A) also enables simple judgement of the effect of sound on humans to be made e.g. "sound at 120 dB(A) is unbearably loud". This can be interpreted as "sound at one million times the human threshold of hearing is unbearably loud".

The dB_{ht}(Species)

Concerns over the environmental effects of offshore seismic shooting using airguns prompted the authors in 1995 to propose a formal perception scale for application to a wide range of species [5]. The dB_{ht}(Species) level is the scale which has been developed; it is estimated by passing the sound through a filter that mimics the hearing ability of the species, and measuring the level of sound after the filter; the level expressed in this scale is different for each species (which is the reason that the specific name is appended) and corresponds to the perception of the sound by that species. A set of coefficients is used to define the behaviour of the filter so that it corresponds to the way that the acuity of hearing of the candidate species varies with frequency: the sound level after the filter corresponds to the perception of the sound by the species. The scale may be thought of as a dB scale where the species' hearing threshold is used as the reference unit; typical thresholds are shown below. A single number (the dB_{ht}(Species)) therefore describes the effects of the sound on that species.

Not for Public Information

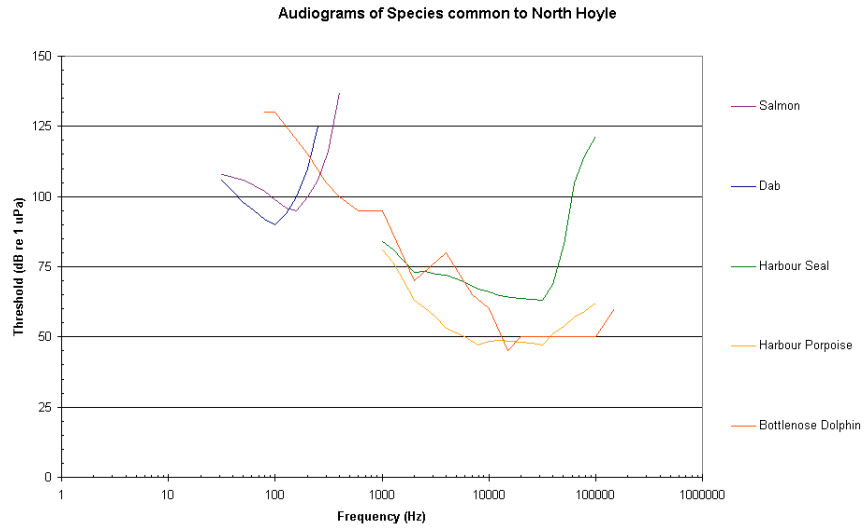

Figure A2. Typical audiograms

**Draft:
Not for Public Information**

11 Appendix B - Details of instrumentation and measurement techniques.

Hydrophone measurement system.

Figure B.1.1 presents a diagram of the Subacoustech underwater noise measurement system. On the left two hydrophones are shown, a B&K 8106 hydrophone and a B&K 8105 hydrophone. Depending on the characteristics of the noise source,

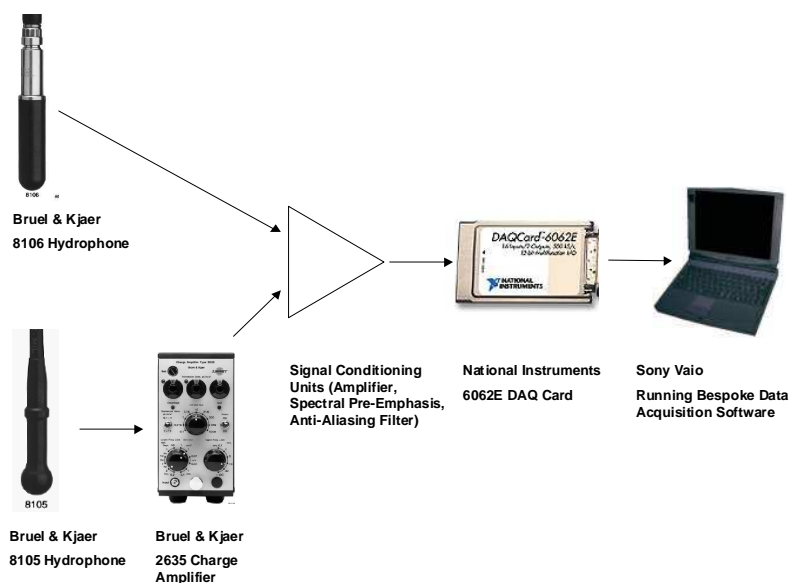

Figure B.1. Measurement system diagram.

measurements will be taken with either the 8106, the 8105, or both hydrophones. The hydrophones exhibit the following electro-acoustic properties:

8105 Hydrophone

receiving sensitivity of -205 dB re 1 V/ μ Pa.

suitable for measurements within the frequency range 0.1 Hz to 160 kHz

8106 Hydrophone

receiving sensitivity of -174 dB re 1 V/ μ Pa.

suitable for measurements within the frequency range 7 Hz to 80 kHz

equivalent noise level well below sea-state zero

The 8105 hydrophone is connected to a B&K 2635 charge amplifier which has variable gain and includes a 2 Hz high pass filter. The 8106 hydrophone includes a 10 dB pre-amplifier, which is supplied by a Subacoustech 68E0101 power supply.

Before digitisation, the hydrophone signals are conditioned using a selection of signal conditioning units. The signal conditioning includes a switchable spectral pre-emphasis stage, a switchable amplifier stage, and an anti-aliasing filter stage.

Underwater noise typically several orders of magnitude greater at low frequencies than high frequencies. To make full use of the DAQ card's dynamic range, the signal can be pre-emphasised, so that upon digitisation the incoming signal is at a similar level across all frequencies. Similarly, the signal is amplified to match the signal's level to the DAQ card's input range. Finally, unwanted high frequency components are removed using an anti-aliasing filter.

The conditioned hydrophone signal is digitised using a National Instruments 6062E DAQ card installed in a Sony Vaio PCG-FX101 laptop computer. The card has the following specification:

- 1 12 bit resolution, which equates to a dynamic range of 72.2 dB
- 2 variable sample rate of up to 500 kHz, however measurements will typically be made using a sample rate of 300 kHz and above to give a bandwidth of at least 150 kHz

Electrical grounding of the equipment is achieved using a brass plate either in the hull or immersed over the side of the vessel. In addition to this, all measurements systems are battery powered, removing contamination of the signal by electrical and mechanical noise from a generator. During measurements, all electrical and mechanical systems on board the vessel are shut down to minimise vessel noise (unless safety considerations require either the VHF radio or Radar).

To further minimise vessel noise contamination, the hydrophones are deployed approximately 10 metres from the boat. The hydrophones are suspended at suitable depths from an anti-heave buoy, and are fastened to the vessel via an anti-shock cable mount.

Sound speed profile measurement.

Underwater noise measurements, in conjunction with relevant sound velocity profiles, allow computer modelling of underwater noise propagation. A conductivity, temperature and depth (CTD) probe provides the required parameters for the calculation of sound speed and can be lowered through the water column to provide a sound speed profile. Measurement are made using a Valeport 600 MK II CTD probe, in conjunction with a National Instruments 6062E DAQ card to measure conductivity and temperature as a function of depth, which may be used to evaluate sound velocity profiles.

Not for Public Information

Other measurements.

The following records are also made for each underwater noise measurement:

- 1 GPS co-ordinates (accurate to 10 metres)
- 2 time and date
- 3 wind speed and direction
- 4 sea state
- 5 local shipping movements

- 6 relevant video recordings
- 7 water depth

Quality assurance.

The following quality assurance measures are undertaken:

- 1 all equipment is inspected and tested prior to use;
- 2 while at sea, measurements are inspected during recording using both audio and visual techniques, including spectral analysis, for common errors such as clipping and noise contamination;
- 3 before publication, measurements are scrutinised by at least two members of staff;
- 4 sample sound files are time histories are included with each report to allow independent verification of the measurement's quality and,
- 5 calibration certificates are included in each report for relevant equipment.

**Draft:
Not for Public Information**

12 Appendix C - Description of windfarm related noise sources.

Sources of windfarm related underwater noise.

Below is a list of some of the potential sources of windfarm related noise that have been identified and which may be measured as part of the COWRIE study:

- 1 geophysical survey,
- 2 pile installation,
- 3 cable trenching,
- 4 rock back filling,
- 5 scour protection installation,
- 6 construction and support vessel machinery, and
- 7 operational wind turbines.

**Draft:
Not for Public Information**

13 Appendix D - Calibration charts.



Calibration Chart for Hydrophone Type 8106 Serial No.:2256725



Brüel & Kjær

Calibration Chart for Hydrophone Type 8106
 Serial No.: 2256725
 Reference Sensitivity at 250 Hz $\pm 2\%$ at 23 °C
 Voltage Sensitivity (Open Circuit Sensitivity):
~~172.6~~ 234.4 dB ± 0.25 dB re 1 V/ μ Pa** or 2344 μ V/Pa
 Frequency Response (at ref. pos.):
 Individual Free Field Frequency Response Curve attached
 Measurement Uncertainty: (re 4 kHz)
 4 to 80 kHz ± 1.5 dB
 80 to 100 kHz ± 1.8 dB
 100 to 125 kHz + 3.5 dB, - 1.5 dB

Summarized Specifications (re 250 Hz)
 Frequency Response (tolerance field excluding measurement uncertainty):
 10 Hz to 10 kHz + 0.5 dB, - 3 dB
 7 Hz to 30 kHz + 0.5 dB, - 6 dB
 3 Hz to 80 kHz + 6 dB, - 10 dB

Horizontal Directivity 20 kHz: (radial XY-plane) ± 2 dB 
Vertical Directivity 20 kHz: (radial XZ-plane) ± 3 dB 

Note: All values are typical at 25°C (77°F), unless measurement uncertainty or tolerance limit is specified. All uncertainty values are specified at 2 σ (i.e. expanded uncertainty using a coverage factor of 2).

CE
 For further information, see Product Data Sheet BP 0317

Date 08 Feb 07 Signature 

Physical (mm)

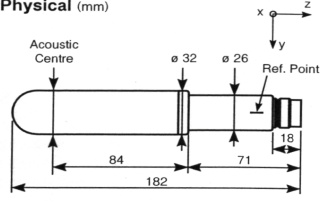

Acoustic Centre
 ø 32 ø 26 Ref. Point
 84 182 71 18

Weight (excluding cable): 382 g

Preamplifier
 Gain: 10 dB
Maximum Output Signal: 3.5 V or 28 mA for a 12 V supply; 7.0 or 28 mA for a 24 V supply
High-pass Filter: - 3 dB at 7 Hz (± 2 Hz)
Maximum Output Effect: 50 mW
Output Impedance: < 30 Ω
Caution: Do not exceed 12 V Insert-voltage calibration signal

Environmental
Operating Temperature Range: - 10° C to + 60° C
Storage Temperature Range: - 40° C to + 80° C
Change of Voltage Sensitivity with Temperature: 0 to 0.01 dB/°C
Change of Sensitivity with Static Pressure: 0 to - 1 x 10⁻⁷ dB/Pa (0 to - 0.01 dB/atm)
Maximum Operating Static Pressure: 9.8 x 10⁶ Pa (100 atm)
Allowable Total Radiation Dose: 5 x 10⁷ Rad

For further information see User Manual

* Sensitivity Traceable to:
 DPLA: Danish Primary Laboratory of Acoustics
 NIST: National Institute of Standards and Technology, USA
 ** 1 Pascal = 1N/m² = 10 μ bar

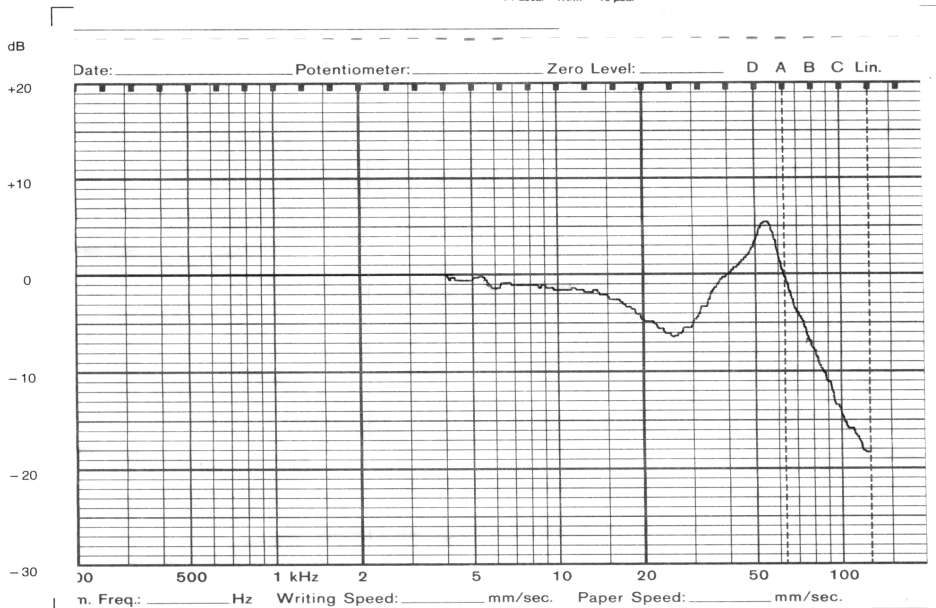



Calibration Chart for Hydrophone Type 8105

Serial No. *1461320*

Reference Sensitivity at *250* Hz* at *23* °C including 10m integral cable

Cable Capacitance 150 pF/m typical

Open Circuit Sensitivity:

Voltage Sensitivity:
2050 dB re 1 V/μPa** or *562* μV/Pa

Charge Sensitivity: *407 · 10⁻³* pC/Pa

Capacitance (including 10m cable) *2250* pF

Leakage Resistance: *> 1 · 10⁻⁴* MΩ at *23* °C

Frequency Response:
 Individual Free Field Frequency Response Curve attached

Date *90-02-05* Signature *OM*

Summarized Specifications:

Usable Frequency Range: 0,1 Hz to 160 kHz ^{+2 dB} _{-10 dB}

Linear Frequency Range: 0,1 Hz to 100 kHz ^{+0,5 dB} _{-4 dB}

Horizontal Directivity 100 kHz:
 (XY-plane) typical ± 2 dB

Vertical Directivity 100 kHz (270°):
 (XZ-plane) typical ± 2 dB

Physical (mm):

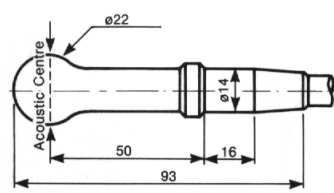

Operating Temperature Range:
 Short term -40°C to +120°C
 Continuous -40°C to + 80°C

Change of Sensitivity with Temperature:
 Charge 0 to 0,03 dB/°C
 Voltage 0 to -0,03 dB/°C

Change of Sensitivity with Static Pressure:
 0 to -3 × 10⁻⁷ dB/Pa
 (0 to -0,03 dB/atm)

Allowable Total Radiation Dose: 5 × 10⁷ Rad

Maximum Operating Static Pressure:
 9,8 × 10⁶ Pa (100 atm)

Cable:
 Two conductors shielded low noise
 Waterblocked to MIL-C-915

Weight including 10m cable: 1,6 kg

For further information see instruction manual

* Traceable to NBS
 ** 1 Pascal = 1 N/m² = 10 μbar

BC 0177-12

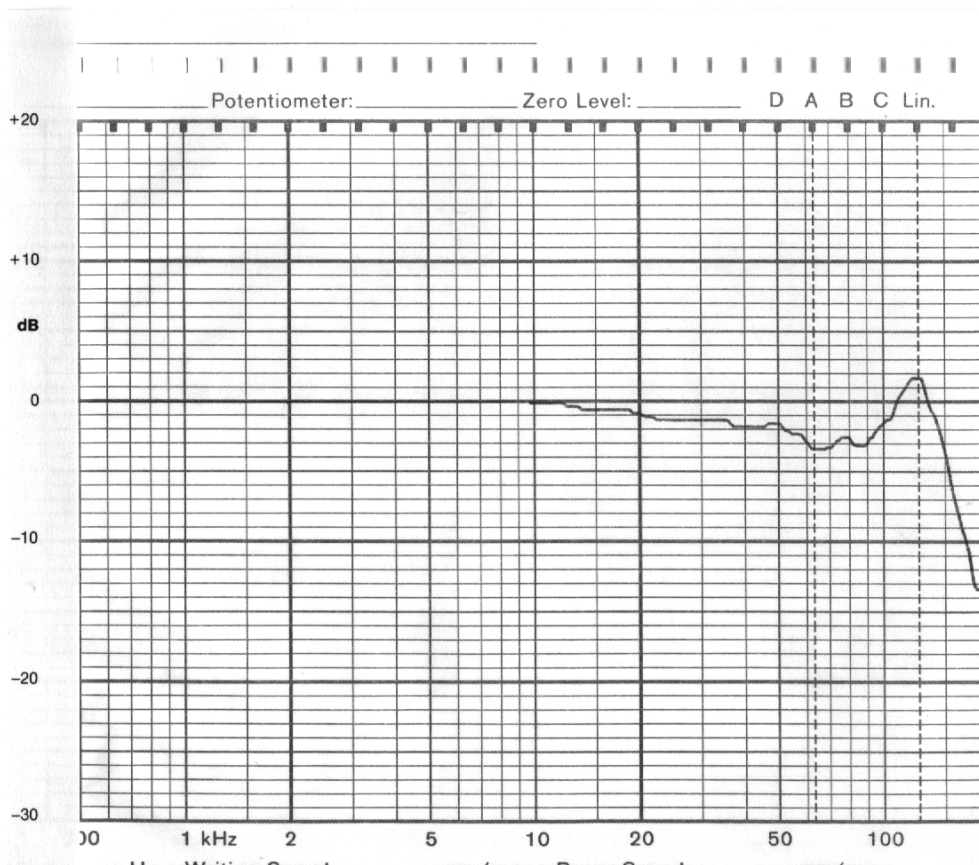



Certificate of Calibration

Board Information

Serial Number: C55869
NI Part Number: 186554E-01
Description: DAQCard-6062E

Certificate Information

Certificate Number: 222115
Date Printed: 05-FEB-2001
NI Part Number: 184632A-01

Calibration Date: 05-FEB-2001
Calibration Interval: 12 Months
Calibration Due: 05-FEB-2002

Ambient Temperature: 24 °C
Relative Humidity: 43 %

National Instruments certifies that at the time of manufacture, the above product was calibrated in accordance with applicable National Instruments procedures. These procedures are in compliance with relevant clauses of ISO 9002 and are designed to assure that the product listed above meets or exceeds National Instruments specifications.

National Instruments further certifies that the measurements standards and instruments used during the calibration of this product are traceable to the National Institute of Standards and Technology or are derived from accepted values of natural physical constants.

The environment in which this product was calibrated is maintained within the operating specifications of the instrument and the standards.

For questions or comments, please contact National Instruments Technical Support.

Signed,

Domingo Salcido
Operations Manager

National Instruments has been registered as compliant with the ISO 9002-1994 standard.



09/08/00
321722C-01

14 Appendix E - Record of changes.

1. This is a controlled document.
2. Additional copies should be obtained through the Subacoustech Librarian.
3. If copied locally, each document must be marked "Uncontrolled Copy".
4. Amendment shall be by whole document replacement.
5. Proposals for change to this document should be forwarded to Subacoustech.

Issue	Date	Details of changes
544R0401	4/12/03	Drafted JRN
544R0402	10/12/04	Internal review BE
544R0403	11/12/04	Redraft JRN
544R0404	16/12/03	Internal review BE
544R0405	17/12/03	Redraft JRN
544R0406	19/12/03	Internal review BE, JL
544R0407	5/1/04	Redraft JRN
544R0408	19/1/04	Internal review BE
544R0409	19/1/04	Redraft JRN, JL
544R0410	27/1/04	Extra information plus drawings JRN, JL
544R0411	13/2/04	Text and drawings altered JRN
544R0412	16/2/04	Alteration of report order JRN
544R0413	16/2/04	Internal review BE
544R0414	18/2/04	Modifications JRN
544R0415	20/2/04	Review DL and redraft JRN
544R0416		Draft issued
544R0417		
544R0418		

1. Originator's current report number	544R04
2. Originator's Name & Location	J.R.N., Subacoustech
3. Contract number & period covered	544; 1 st April 2003 – 30 th January 2004
4. Sponsor's name & location	COWRIE for Crown Estates
5. Report Classification & Caveats in use	UNCLASSIFIED; UNLIMITED DISTRIBUTION.
6a. Date written	Draft: Not for Public Information
6b. Pagination	
6c. References	
7a. Report Title	
7b. Translation / Conference details	
7c. Title classification	UNCLASSIFIED
8. Authors	
9. Descriptors / Key words	Underwater, noise, windfarm, piling, drilling.
10a Abstract	
10b. Abstract classification	UNCLASSIFIED; UNLIMITED DISTRIBUTION.

**Draft:
Not for Public Information**