

COWRIE-EM FIELD 2-06-2004

# **COWRIE 1.5 ELECTROMAGNETIC FIELDS REVIEW**

**The potential effects of electromagnetic fields generated  
by sub-sea power cables associated with offshore wind  
farm developments on electrically and magnetically  
sensitive marine organisms – a review**

FINAL REPORT

Prepared by:

Gill, A.B., Gloyne-Phillips, I., Neal, K.J. & Kimber, J.A.

July 2005

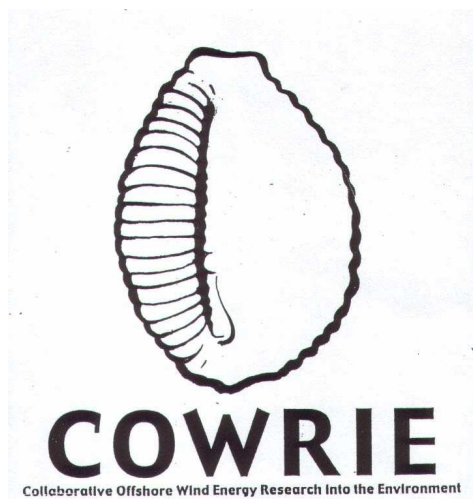

This report has been commissioned by COWRIE

*Cranfield*  
UNIVERSITY  
Silsoe



Centre for Marine and Coastal Studies Ltd

## Contact Details

Dr Andrew B. Gill  
Institute of Water & Environment  
Cranfield University  
Silsoe  
Bedfordshire, MK45 4DT

Tel: 44 (0)1525 863334  
Fax: 44 (0)1525 863344  
<http://www.silsoe.cranfield.ac.uk/iwe/>  
[a.b.gill@cranfield.ac.uk](mailto:a.b.gill@cranfield.ac.uk)  
CU@S ref: DB-1106-ABG

Dr Ian Gloyne-Phillips  
Centre for Marine and Coastal Studies Ltd  
Cammell Lairds Waterfront Park  
Campbeltown Road  
Birkenhead, Merseyside  
CH41 9HP

Tel: 44 (0)151 650 2275  
Fax: 44 (0)151 650 2274

[www.cmacsltd.co.uk](http://www.cmacsltd.co.uk)  
[info@cmacsltd.co.uk](mailto:info@cmacsltd.co.uk)  
CMACS ref: J3021

<b>Contents</b>	<b>Page</b>
<b>1 Executive summary</b>	<b>1</b>
<b>2 Project terminology</b>	<b>4</b>
2.1 Electromagnetic field terminology	4
2.2 Glossary	5
<b>3 Project background</b>	<b>6</b>
3.1 Outline Programme of Work	6
<b>4 Project partners and responsibilities</b>	<b>7</b>
<b>5 Report on Offshore Wind farm Conference</b>	<b>7</b>
<b>6 Collation of available information &amp; Literature review – Biology</b>	<b>10</b>
6.1 Overview of sources of information	10
6.2 General summary of information on electrically and/or magnetically sensitive species	10
6.3 Electrosensitive species review	11
6.3.1 Electric field detection	11
6.4 Magnetosensitive species review	15
6.4.1 Magnetic field detection	15
<b>7 Collation of available information &amp; literature review – Industry</b>	<b>19</b>
7.1 Consultation with Industry	19
7.1.1 Summary of Industry Information Reviewed	20
7.1.2 Sensitivity Assessment (distribution of electrically and magnetically sensitive species)	22
7.1.3 Cabling Strategies	25
7.2 Recent Advances in understanding of EMFs	26
7.2.1 EMF Modelling	26
7.3 Other Sources of Magnetic and Electrical Fields	28
7.3.1 Submarine telecommunications cables	28
7.3.2 Pipelines	30
7.3.3 Other Power Cables	30
7.4 Inferring effects of existing sub-sea cables on EM sensitive species	31
7.5 Summary and Information Gaps	31
<b>8 Update of COWRIE Phase 1 Offshore Wind Farm Cabling Strategy and EMF Modelling</b>	<b>34</b>
8.1 UK Offshore Wind Farm Design Strategy	34
8.1.1 Introduction	34
8.1.2 Summary of Econnect Report	34
8.2 Responses to Questions following COWRIE Phase 1 Report	35
<b>9 Identification and Assessment of Potential Impacts</b>	<b>36</b>
9.1 Overview of Available Information	36
9.2 Assessment of Electromagnetic Fields Impact	37
9.2.1 Induced Electrical Fields	37
9.2.2 Magnetic fields	38
9.2.3 Cumulative Impacts	38
9.3 Assessment of Priority species	38
<b>10 Priorities for further research</b>	<b>41</b>
10.1 COWRIE Phase 2	42
10.1.1 Stage 1 Experimental mesocosm study	42
10.1.2 Stage 1 <i>In situ</i> monitoring	43
10.1.3 Stage 2 <i>in situ</i> and experimental studies	44

## COWRIE 1.5 Electromagnetic Fields

<b>11</b>	<b><i>Monitoring at wind farm sites</i></b>	<b>45</b>
11.1	Introduction	45
11.2	Existing Monitoring	45
11.3	Potential survey methods for electrically and magnetically sensitive species	49
11.3.1	Electrically Sensitive Species	49
11.3.2	Magnetically Sensitive Species	51
11.4	Guidelines for Monitoring	53
<b>12</b>	<b><i>Acknowledgements</i></b>	<b>55</b>
<b>13</b>	<b><i>References</i></b>	<b>55</b>
<b>14</b>	<b><i>Appendices</i></b>	<b>58</b>



## 1 Executive summary

The COWRIE 1.5 Electromagnetic Fields Review specifically considers the potential effects of electromagnetic fields generated by sub-sea power cables associated with offshore wind farm developments on electrically and magnetically sensitive marine organisms. The review was conducted jointly by the Centre for Marine and Coastal Studies Ltd (CMACS) and Institute of Water and Environment, Cranfield University at Silsoe (CU@S). Additional input came from ECONNECT Ltd and the Centre for Intelligent Monitoring Systems (CIMS), University of Liverpool.

Throughout the course of the project there was some confusion about the term electromagnetic field and its present acronym, EMF, which has led to inconsistencies and mistakes in documentation and discussion. Here we suggest a set of unambiguous labels based on standard electrical nomenclature relating to the different components of an electromagnetic field (EMF) field for clarity in any future publication or communication.

The results of the COWRIE Phase 1 work demonstrated that the EMF emitted by industry standard AC offshore cables had a magnetic (B) field component and an induced electric (iE) field component. These EMF components were assessed as being within the range of detection by EM-sensitive aquatic species but whether any potential impact would result remained unknown. It was noted however that a number of monitoring studies for existing wind farms were underway and that these may assist in the determination of potential impact in the future. In addition, during 2003 further consents for development were issued for three strategic areas of the English/Welsh/Scottish coastal zone.

In light of the monitoring studies and the new plans for development, the report presented here provides a comprehensive review and analysis of all information currently available. The aim of the review was to allow COWRIE to prioritise Phase 2 research relating to EMFs associated with offshore wind farms and EM-sensitive species.

The review focussed first on collation of up to date information on the biology of EM-sensitive species and the information from the offshore wind farm industry via published material and consultation. In addition, information from the first international conference dedicated to assessing the environmental impact of offshore wind farms was incorporated. The information collation phase provided the material for the subject specific literature reviews presented in the report and these were used as the basis for a set of specific recommendations that are presented for future COWRIE research relating to EMFs.

A review of material on electrosensitive species showed that there are many fish species within the UK waters which are potentially capable of responding to anthropogenic sources of E field. However, it is not known whether the interaction between the fish and the artificial E field will have any consequences for the fish.

The information available on magnetosensitive species is limited, however it does suggest that potential interactions between EM emissions, of the order likely to be

## COWRIE 1.5 Electromagnetic Fields

associated with wind farm cables, and a number of UK coastal organisms could occur from the cellular through to the behavioural level.

The consultation and review of industry information showed that EM-sensitive species are present at a number of development sites however the present opinion is that whilst there could be an interaction between these species and the sub-sea cables used the result would not be of any significance. It was evident that the industry does try to take into consideration the environmental interaction of EMFs but it is hampered by a serious lack of information and understanding. Recent advances in modelling of cables confirm that EMFs are emitted but the intensity of emissions is location, cable and operation specific.

The offshore wind farm industry is a new and rapidly developing sector and needs to use very large amounts of electrical cabling. There are, however, other anthropogenic sources of electric and magnetic fields that have been present in the marine environment for many years. Whilst the existing E and B field sources (eg. offshore cables and pipelines) are more limited in their spatial extent they do have varying potential to produce electric and/or magnetic fields of comparable magnitude to those associated with the offshore wind farms.

It is clear from the review of industry based material that the issue of electromagnetic (both B and iE field) effects on electrically and magnetically sensitive species has not been addressed in a consistent manner and that there are a number of important misconceptions. The main reason for this is the lack of clear scientific guidance on the significance of effects on receptor species (if any).

Therefore for both B and E/iE fields associated with offshore wind farms we need to:

- Identify the species most likely to interact with the EMFs. This will vary between species according to their habits, conservation status and needs to consider different life stages
- Definitively determine whether these species will be affected
- Assess the potential significance of any effects
- Specifically consider the significance of larger (Round 2) offshore wind farm developments
- Specifically consider cumulative impacts of adjacent developments, not just wind farms.

For all the UK coastal species that are EM-sensitive it is evident that our knowledge of their interaction with anthropogenic EMFs is limited. In order to improve understanding and assist the offshore wind farm industry and regulators in appropriate management of EMFs in the environment we present a prioritised list of species that are most likely to interact with offshore wind farm generated EMFs. Species chosen are benthic species and those with specific life history stages that utilise inshore waters.

Owing to the lack of knowledge relating to EMF emissions and their environmental impact and the rapid pace of development of offshore wind farms it is evident that a fuller understanding of this subject area is urgently required. We envisage a two-stage research programme, with the first stage focussing on:

## COWRIE 1.5 Electromagnetic Fields

1. A one-off mesocosm study involving the enclosure of a suitable area of seabed within which to study the response of a benthic EM-sensitive test-species (e.g. an elasmobranch) to experimentally controlled B fields and induced electrical fields from a sub-sea cable.
2. Monitoring of electrically and magnetically sensitive species at individual wind farms, probably under FEPA conditions, as appropriate to site-specific conditions.

Within the first stage, study 1 aims to definitively determine if there is a response by an electromagnetic sensitive species to the EMF associated with an industry standard offshore wind farm electricity cable. We consider such a study to be the priority for the COWRIE Phase 2 study.

If the mesocosm study and/or the monitoring provide data to conclude that there are effects of EMFs on receptor species then stage 2 should be implemented. Stage 2 should address the following specific studies:

3. A collaborative study to monitor elasmobranch responses to submarine power cable emissions at one or more UK offshore wind farm sites.
4. Collaborative study/studies to follow up potential impacts on magnetically sensitive species and/or non-elasmobranch electrically sensitive species at UK offshore wind farm sites.
5. Specific research to investigate electric and magnetic field significance for UK fish species in controlled environments and *in situ*.

The environmental monitoring requirements for consented offshore wind farms are determined by FEPA licence conditions. The FEPA licence generally states the broad principals of monitoring but leaves the details of that monitoring open for discussions between the developer (and their scientific consultants) and statutory bodies. To assist in this process we have considered monitoring that would be appropriate to individual wind farms in light of the review undertaken. We then have endeavoured to suggest monitoring that would be suitable both for consented wind farms, should further monitoring be invoked, and for planned wind farms should future FEPA licence conditions specify such monitoring outright. We have included an overview of possible survey methods for electrically and magnetically sensitive species including advantages and disadvantages. Finally, we offer guidance for studies which seek to monitor fish at offshore wind farm sites in relation to E and B fields.

## 2 Project terminology

### 2.1 Electromagnetic field terminology

EMF (upper case letters) is standard nomenclature within the electrical engineering profession and electricity industry for the electromagnetic field. However, throughout the course of this project there has been some confusion about the term EMF. The electromagnetic field has been confused with the resultant (induced) electrical field and the fact that there are two fundamentally different fields (electric and magnetic fields) present has often been overlooked. In addition, emf (lower case letters) is also a fundamental electrical acronym, standing for electromotive force which is measured in Volts. This has resulted in some unnecessary confusion when communicating with electrical systems engineers and the like.

We suggest that for clarity any future COWRIE publication or communication should use EMF to describe only the direct electromagnetic field, in line with the standard electrical terminology. The two constituent fields of the EMF should be clearly defined as the E (Electric) field and the B (Magnetic) field, whilst the induced electric field should be labelled (iE field).

The following provides a highly simplified overview of the fields associated with industry-standard submarine power cables, highlighting the magnetic and induced electrical fields that are of interest to the present study:

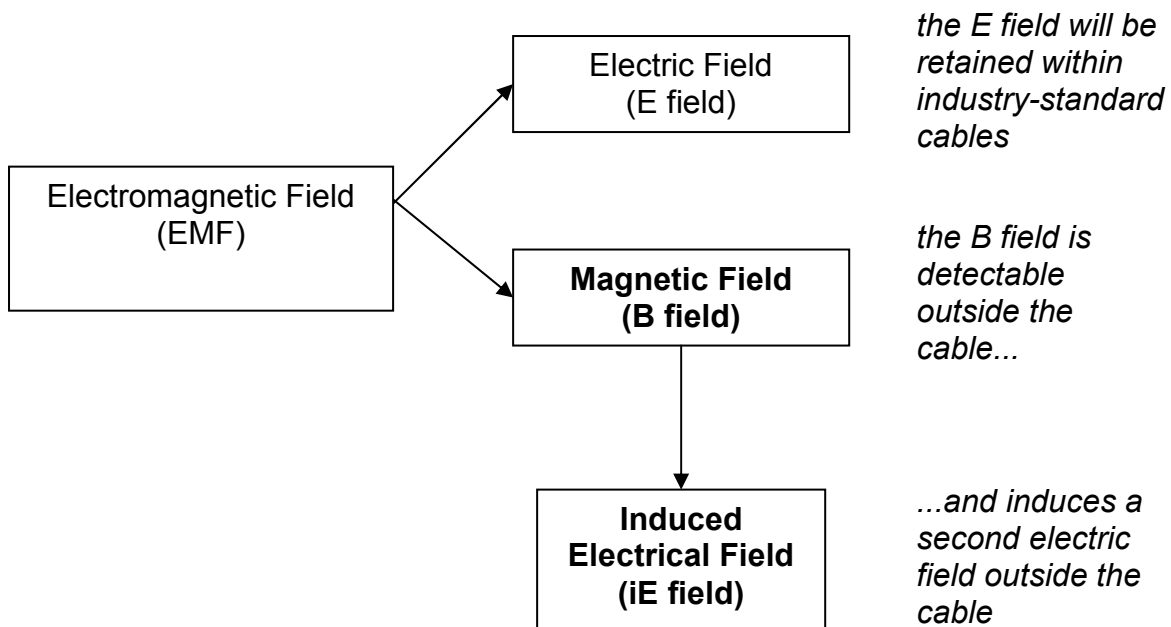

## 2.2 Glossary

A	- Ampere
AC	- Alternating Current
AoL	- Ampullae of Lorenzini
ASCOBANS	- Agreement on the Conservation of Small Cetaceans in the Baltic and North Seas
B field	- Magnetic field
CEFAS	- Centre for Environment, Fisheries and Aquaculture Science
CIMS	- Centre for Intelligent Monitoring Systems, University of Liverpool
CITES	- Control of Trade in Endangered Species
CMACS	- Centre for Marine and Coastal Studies Ltd
COWRIE	- Collaborative Offshore Wind Energy Research into the Environment
CU@S	- Cranfield University at Silsoe
DEFRA	- Department for Environment, Food and Rural Affairs
DTI	- Department of Trade and Industry
DC	- Direct Current
DGPS	- Differential Global Positioning System
E field	- Electric field
EC	- European Commission
EM	- Electromagnetic
EMF	- Electromagnetic field
ES	- Environmental Statement
FEPA	- Food and Environment Protection Act 1985
GIS	- Geographic Information System
GOV	- Grande Overture Verticale fishing gear
HVDC	- High Voltage Direct Current
Hz	- Hertz (frequency)
ICES	- International Council for the Exploration of the Seas
iE	- Induced electric field
IUCN	- International Union for the Conservation of Nature
kV	- kilovolt
$\mu\text{A}/\text{m}^2$	- micro amps per metre squared
$\mu\text{T}$	- micro tesla
$\mu\text{V}$	- micro volt
$\mu\text{V}/\text{m}$	- micro volt per metre
$\mu\text{V}/\text{cm}$	- micro volt per centimetre
WCA	- Wildlife and Countryside Act 1981
UKCPC	- UK Cable Protection Committee

### 3 Project background

In 2002 COWRIE identified as priority research an assessment of electromagnetic (EM) fields generated by offshore wind farm power cables and their possible effect on organisms that are sensitive to these fields. A consortium, led by Centre for Marine and Coastal Studies Ltd (CMACS), was contracted to carry out a Phase 1 investigation into the following:

- The likely EMF emitted from a subsea power cable.
- A suggested method to measure EMF *in situ*, which could be applied by wind farm developers or in future projects.
- Guidance on mitigation measures to reduce EMF.
- Consideration of the results for the next stage of investigation into the effects of EMF on electrosensitive species.

(for details see:

[http://www.thecrownestate.co.uk/1351\\_emf\\_research\\_report\\_04\\_05\\_06.pdf](http://www.thecrownestate.co.uk/1351_emf_research_report_04_05_06.pdf))

The results of the Phase 1 work demonstrated that the EMF emitted by industry standard AC offshore cables had a magnetic (B) field component and an induced electric (iE) field component. These EMF components were assessed as being within the range of detection by EMF sensitive aquatic species but whether any potential impact would result remained unknown. It was noted however that a number of monitoring studies for existing wind farms were underway and that these may assist in the determination of potential impact in the future. In addition, during 2003 further consents for development were issued for three strategic areas of the English/Welsh/Scottish coastal zone. This significant increase in development within specific coastal areas again raised the question of whether species that are electro- and/or magneto- receptive will be affected. Answering the question is important as many of the species known to be EM sensitive are currently of conservation concern or are vulnerable to the effects of human activity (see Gill, 2005) and developers are required to assess their impact on these species.

In light of the monitoring studies and the new plans for development, the report presented here provides a comprehensive review and analysis of all information currently available. The aim of the review was to allow COWRIE to prioritise Phase 2 research relating to EMFs associated with offshore wind farms and EM sensitive species.

#### 3.1 Outline Programme of Work

The project followed a two-stage approach of information collation followed by review and reporting as outlined below:

##### Information Collation

- An update of COWRIE Phase 1 information relating to electrically sensitive species

## COWRIE 1.5 Electromagnetic Fields

- A new collation of information relating to magnetically sensitive species
- Published and unpublished literature on EMF (including consultations)
- Development of a database of published literature

### Literature Review and Reporting

- Update COWRIE Phase 1 literature review
- Assessment of the significance of any interaction between offshore wind farms and EM-sensitive species
- Identification of priorities for further research
- Suggestions for monitoring at individual wind farms

## 4 Project partners and responsibilities

The project was conducted jointly by the Centre for Marine and Coastal Studies Ltd (CMACS) and the Institute of Water and Environment, Cranfield University at Silsoe (CU@S). CMACS undertook a consultation with offshore wind farm developers and associated industry partners, followed by collation, synthesis and review of information obtained and a review of published and unpublished industry based literature on electromagnetic fields (EMF). CU@S focussed on the collation of information, synthesis and review of academic publications and reports on electrically and magnetically sensitive species. Both partners worked together on the synthesis of the data collation, monitoring and recommendations for COWRIE 2.

The project also had input from ECONNECT Ltd and the Centre for Intelligent Monitoring Systems (CIMS), University of Liverpool. ECONNECT Ltd specifically provided an update on UK offshore wind farm cabling strategies, and CIMS provide updates for technical aspects of the COWRIE Phase 1 EMF study.

## 5 Report on Offshore Wind farm Conference

Scientific researchers and developers in Scandinavia have carried out and supported the only studies to date on the direct influences of EMF from offshore wind farm power cables on marine ecology. The results of these investigations were presented at the "Offshore Wind Farms and the Environment, Horns Rev and Nysted" Conference held in Billund, Denmark on 21-22 September 2004. This was the first conference globally to consider offshore wind farms and their interaction with the environment. The conference represented an important starting point for the COWRIE 1.5 review.

Both principle authors of the review attended the conference and presented a poster entitled "Ecological Significance of Electromagnetic Fields generated by the Offshore Wind Industry". The poster was based on findings from the COWRIE Phase 1 study.

## COWRIE 1.5 Electromagnetic Fields

In the context of the present report there were two main studies of interest reported at the conference. The first related to EMFs and fish migration and the second related to species colonisation of the wind farm sub-sea structures.

### *Electromagnetic fields*

A Danish study by Bio/consult as (2002) for SEAS at the Vindeby offshore wind farm cited evidence of the sensitivity of certain bony fish to B fields. The conclusion was that the magnetic fields around the cables may be of sufficient magnitude to affect sensitive fish but only up to one metre from the cable (when the field was 33.1  $\mu$ T), after which the field was predicted to be indistinguishable from the earth's field. These conclusions were based on desktop assessment for 10 kV three-phase, 50 Hz AC cables with maximum current in each of the three phases of the cable of 260 A.

Bio/consult as also conducted a study of fish response to the presence of the main power cable to shore at Nysted offshore wind farm in the southern Baltic Sea. The study only considered the magnetic component of the EMF. The electrical component was assumed to be contained within the cable shielding and there was no consideration of induced E fields. The project status report (Hvidt *et al.* 2003) details the investigation of changes in populations of six bony fish species around the cable route. The study utilised passive fishing gear on both sides of the cable and was designed to test whether fish would cross the cable. The six most abundant species were chosen for analysis; herring *Clupea harengus*, common eel *Anguilla anguilla*, Atlantic cod *Gadus morhua*, eelpout *Zoarces viviparous*, short-spined sea scorpion *Myoxocephalus scorpius* and flounder *Platichthyes flesus* representing a mixture of migratory and non-migratory fish species. The common eel was highlighted as being particularly sensitive to EMFs.

The methods used in the study did not reveal any effect of the cable on the species investigated. However, Hvidt *et al.* (2003) expressed some doubt over the methods. They considered the nets to have been employed at too great a distance from the cable to detect whether the EMF had repelled or attracted fish. In addition, the nets either side of the cable were parallel and could have shadowed one another. Nevertheless, no significant differences in catch numbers of fish were found either side of the net.

Given the lack of electrosensitive species in the study area (Hvidt, *pers. comm.*) the study is not of use in assessing the significance of induced electrical fields; however, despite the acknowledged methodological difficulties the study does represent the first direct attempt to monitor for any impact of electromagnetic field on fish at a wind farm site.

### *Colonisation of structures*

The species colonisation of the wind farm sub-sea structures was well illustrated by video sequences and a presentation of the results by Bio/consult as. The main importance in the context of EMFs is that the increased faunal activity provides a potential food source for predators, some of which are magnetically sensitive, some electrically sensitive and some that are both. Such indirect association between EM sensitive species and increased food availability around offshore wind farm structures needs to be considered further.



## COWRIE 1.5 Electromagnetic Fields

### *Conference summary outcome*

The overall message from the conference was that offshore wind farms do impact coastal fauna however whether these impacts are positive or negative or neutral remains to be determined. In terms of magnetic fields there was very little conclusive evidence of their effects, if any, on receptor species and no consideration of the induced electric fields associated with the sub-sea cables used by offshore wind farms.

## 6 Collation of available information & Literature review – Biology

### 6.1 Overview of sources of information

To determine the current state of knowledge regarding the importance of both electric and magnetic fields to receptor organisms an extensive search of academic library databases was conducted through Cranfield University. The main sources of information were Web of Knowledge (comprising, Science Citation Index, Social Sciences Citation Index, Arts & Humanities Citation Index; all 1981 to present), Cambridge Abstracts (Oceanic Abstracts; 1960 to present), and Scirus ([www.scirus.com](http://www.scirus.com) - the most comprehensive science-specific Internet search engine). The databases were searched for any information relating to aquatic species that are considered to be or have the potential to be sensitive to electromagnetic fields, i.e. either the electric field or the magnetic field or both. We also considered any information linking wind farms and EMFs, and other emission sources (both artificial and natural). A number of data sources were from outside the UK; in these cases we interpreted the information in the context of UK coastal water species where appropriate. The material obtained was categorised by core subject areas (shown in Table 1) and then specific information relating to electrosensitive species and magnetosensitive species was reviewed separately.

### 6.2 General summary of information on electrically and/or magnetically sensitive species

**Table 1.** Summary of articles and documents reviewed assigned to major subject categories. Full bibliographies for each category are in the Appendix specified.

Subject			Number of sources	Appendix
Offshore wind farms	General effects		12	1a
	Specific organisms		3	1b
Other artificial e-sources	General effects		5	1c
	Specific organisms		4	1d
Chondrichthyans (Sharks, skates & rays)	Electroreception	General	16	2a
		Physiology	83	2b
		Behaviour	12	2c
	Magnetoreception	General	27	3a
		Physiology	23	3b
		Behaviour	4	3c
Other organisms	Electroreception	General	9	4a
		Physiology	3	4b
		Behaviour	2	4c
	Magnetoreception	General	39	5a
		Physiology	26	5b
		Behaviour	38	5c
Natural E field sources			10	6
<b>Total</b>			<b>316</b>	

## **6.3 *Electrosensitive species review***

### **6.3.1 Electric field detection**

Electric fields in the marine environment are directly emitted either as a result of biochemical, physiological and neurological processes within an organism or via anthropogenic sources. Induced E fields can also occur as a result of the organism itself or oceanic waters interacting with geomagnetic flux lines. Electrosensitive organisms are known to be able to detect two types of E field: localised polar and larger scale uniform E fields.

The major group of organisms that are known to be electroreceptive are the Elasmobranchs and their relatives (collectively known as Chondrichthyes; see Table 2). They possess Ampullae of Lorenzini (AoL) which consist of a series of pores on the surface of the skin, leading to canals approximately 1 mm in diameter and up to 20 cm long (Murray 1974; Zakon 1986; Adair *et al* 1998; von der Emde 1998). The canals are filled with a conductive mucopolysaccharide jelly, which has a low resistance similar in magnitude to that of seawater (25 to 30 ohms per cm; 1974; Zakon 1986; Adair *et al* 1998; von der Emde 1998). At the end of the canals are clusters of ampullae (alveoli with ampullary receptor cells situated on their walls), which enable elasmobranchs to detect very weak voltage gradients (down to  $0.5\mu\text{V}/\text{m} = 5\text{nV}/\text{cm}$ ) in the environment around them (Kalmijn 1971; Murray 1974; Boord & Campbell 1997). On encounter with a polar E field an elasmobranch can locate the emission based on differential voltage potential at the pores with reference to the internal potential of the body. In a uniform E-field the different length and orientation of the AoL canals allows an elasmobranch to compare voltage gradient change.

In most sharks the pores are evenly distributed between the dorsal and ventral surfaces of the head (Bodznick & Boord 1986; Tricas 2001). In the dorso-ventrally flattened rays and skates the pore pattern is concentrated on the ventral surface particularly in association with the mouth (Raschi 1986; Tricas 2001). This permits accurate location of polar bioelectric fields of buried prey and ensures the mouth of the ray is brought close to the prey (Raschi 1978; Bodznick & Boord 1986; Tricas 2001). The ability to detect electrical fields starts in the embryonic and juvenile stages of life (Kaijura 2003) and is likely to vary through the life of an elasmobranch. Evidence for changes in sensitivity with age and size of individuals is a present inconclusive for polar E fields. However, within a uniform electrical field the AoL system becomes more sensitive in larger fish as the spaces between pores become wider and canals get longer (Raschi 1978; Tricas 2001).

The other species that are electrosensitive (see Table 2) do not possess specialized electroreceptors but are able to detect induced voltage gradients associated with water movement and geomagnetic emissions (see section 6.4.1). The actual sensory mechanism of detection is not yet properly understood. It is likely that the E fields that these species respond to is associated with peak tidal movements which can create fields in the range of  $8\text{-}25\mu\text{V}/\text{m}$  (Barber & Longuet-Higgins 1948; Pals *et al* 1982).

Species that have specialised electroreceptors naturally detect bioelectric emissions from prey, conspecifics and potential predators/competitors (the latter being more

## COWRIE 1.5 Electromagnetic Fields

likely for early life history stages). The E-sense is primarily used in close proximity to the E fields in the range detectable and other senses (such as hearing or smell) are used at distances of more than approximately 30cm from the E field. This means that the E-sense is highly tuned for the final stages of feeding or detecting others. Species with an E-sense have also been shown in experimental studies to respond to artificial sources of electric fields. It has been demonstrated that the response to DC dipole fields is similar to the behavioural response to bioelectric field emission. Limited studies have so far determined that DC and low frequency AC (0.5 – 20Hz) E fields are responded to the most (Brown *et al.* 1974; New & Tricas 1998).

### *Evidence from electric field studies*

The comprehensive search of information in the public domain revealed that there are very few studies that have considered the interactions between electrosensitive fish and anthropogenic sources of E field:

Marra (1989) reported that a major optical communication cable was found to be damaged by biting elasmobranchs (Carcharhinid species and *Pseudocarcharias kamoharai*). The cable emitted two forms of electric fields. The first was an induced 50 Hz E field (6.3 $\mu$ v/m @ 1m) caused by an induced AC Current through the power feed to the cable. The second E field (1 $\mu$ v/m @ 0.1m) was induced by the sharks crossing the magnetic field emitted by the cable. The damaged caused by the fish bites lead to sections of the cable being reinforced at depths where the species that bit them were most likely to occur. Subsequent behavioural tests in the laboratory and at sea were inconclusive, however the cable reinforcing reduced the incidence of shark bites damaging the cable.

Poddubny (1967) – observed that the electroreceptive sturgeon (*Acipenser gueldenstaedtii*) veered away from terrestrial high voltage overhead lines (110kV) crossing above the water. The sturgeon also swam slowly near to where the lines crossed and swam faster once past them.

Gill & Taylor (2001) – limited laboratory based evidence that the benthic elasmobranch (*Scyliorhinus canicula*) avoids DC E fields at emission intensities similar to those predicted from offshore wind farm AC cables. The same fish were attracted to DC emissions at levels predicted to emanate from their prey.

Walker (2001) specifically considered the behavioural interaction of sharks and other marine fauna with high voltage DC power cables and electrodes crossing between Australia and Tasmania. The conclusion of the study was that there would be no effect of the power cables and electrodes on the species considered. It was mentioned that the effects on benthic species should be determined, as they are more likely to come into close contact with any EMF emitted.

The study by Marra is most comparable with the results from COWRIE 1.0 which modelled and measured iE fields of 91 $\mu$ v/m emitted by industry standard 50 Hz three phase cables buried to 1m.

**Table 2. List of electrosensitive species in UK coastal waters.**

Species	Common name	Relative occurrence in UK waters	Evidence of response to E fields
<b>Elasmobranchii</b>	<b>Sharks</b>		
<i>Cetorhinus maximus</i>	Basking shark	Common	
<i>Galeorhinus galeus</i>	Tope	Common	
<i>Lamna nasus</i>	Porbeagle	Common	
<i>Mustelus asterias</i>	Starry smooth-hound	Common	
<i>Scyliorhinus canicula</i>	Small-spotted catshark	Common	✓
<i>Squalus acanthias</i>	Spurdog	Common	
<i>Alopias vulpinus</i>	Thintail thresher	Occasional	
<i>Chlamydoselachus anguineus</i>	Frilled shark	Occasional	
<i>Dalatias licha</i>	Kitefin shark	Occasional	
<i>Isurus oxyrinchus</i>	Shortfin mako	Occasional	
<i>Mustelus mustelus</i>	Smooth-hound	Occasional	
<i>Prionace glauca</i>	Blue shark	Occasional	✓
<i>Scyliorhinus stellaris</i>	Nursehound	Occasional	
<i>Centrophorus squamosus</i>	Leafscale gulper shark	Rare	
<i>Centroscyllium fabricii</i>	Black dogfish	Rare	
<i>Deania calcea</i>	Birdbeak dogfish	Rare	
<i>Echinorhinus brucus</i>	Bramble shark	Rare	
<i>Etmopterus spinax</i>	Velvet belly lantern shark	Rare	
<i>Galeus melastomus</i>	Blackmouth catshark	Rare	
<i>Heptranchias perlo</i>	Sharpnose sevengill shark	Rare	
<i>Hexanchus griseus</i>	Bluntnose sixgill shark	Rare	
<i>Oxynotus centrina</i>	Angular rough-shark	Rare	
<i>Scymnodon obscurus</i>	Smallmouth velvet dogfish	Rare	
<i>Scymnodon squamulosus</i>	Velvet dogfish	Rare	
<i>Somniosus microcephalus</i>	Greenland shark	Rare	
<i>Sphyrna zygaena</i>	Smooth hammerhead	Rare	
<i>Squatina squatina</i>	Angelshark	Rare	
<b>Elasmobranchii</b>	<b>Skates &amp; Rays</b>		
<i>Amblyraja radiata</i>	Starry ray	Common	
<i>Raja clavata</i>	Thornback ray	Common	✓

## COWRIE 1.5 Electromagnetic Fields

Species	Common name	Relative occurrence in UK waters	Evidence of response to E fields
<i>Dipturus nidarosiensis</i>	Norwegian skate	Occasional	
<i>Leucoraja circularis</i>	Sandy ray	Occasional	
<i>Leucoraja fullonica</i>	Shagreen ray	Occasional	
<i>Leucoraja naevus</i>	Cuckoo ray	Occasional	
<i>Raja brachyura</i>	Blonde ray	Occasional	
<i>Raja microocellata</i>	Small-eyed ray	Occasional	
<i>Raja montagui</i>	Spotted ray	Occasional	
<i>Raja undulata</i>	Undulate ray	Occasional	
<i>Amblyraja hyperborea</i>	Arctic skate	Rare	
<i>Bathyraja spinicauda</i>	Spinetail ray	Rare	
<i>Dasyatis pastinaca</i>	Common stingray	Rare	
<i>Dipturus batis</i>	Common skate	Rare	
<i>Dipturus oxyrinchus</i>	Long-nose skate	Rare	
<i>Mobula mobular</i>	Devil fish	Rare	
<i>Myliobatis aquila</i>	Common eagle ray	Rare	
<i>Rajella fyllae</i>	Round ray	Rare	✓
<i>Rostroraja alba</i>	White skate	Rare	
<i>Torpedo marmorata</i>	Spotted/marbled torpedo ray	Rare	
<i>Torpedo nobiliana</i>	Atlantic torpedo ray	Rare	
<b>Holocephali</b>	<b>Chimaeras</b>		
<i>Chimaera monstrosa</i>	Rabbit fish	Rare	✓
<b>Agnatha</b>	<b>Jawless fish</b>		
<i>Lampetra fluviatilis</i>	European river lamprey	Common	✓
<i>Petromyzon marinus</i>	Sea lamprey	Occasional	✓
<b>Teleostei</b>	<b>Bony fish</b>		
<i>Anguilla anguilla</i>	European eel	Common	✓
<i>Gadus morhua</i>	Cod	Common	✓
<i>Pleuronectes platessa</i>	Plaice	Common	✓
<i>Salmo salar</i>	Atlantic salmon	Common	✓

Note: All species shown have been recorded in UK coastal waters at depths less than 200m.

### Data sources

[In addition to sources from review]

Froese, R. and D. Pauly. eds. (2003). FishBase. World Wide Web electronic publication. [www.fishbase.org](http://www.fishbase.org), version 04 June 2003.

Vas, P. (1991). A field guide to the sharks of British coastal waters. Field Studies Council AIDGAP Publication No. 205.

### **Conclusion**

What is evident from this analysis is that there are many electrosensitive fish which are potentially capable of responding to anthropogenic sources of E field. However, we do not know whether the interaction between the fish and the artificial E field will result in a response or have any consequences for the fish.

## **6.4 Magnetosensitive species review**

### **6.4.1 Magnetic field detection**

Organisms that are known (or presumed) to be able to detect magnetic fields can be categorised into two groups based on their mode of B field detection: 1- induced electric field detection and 2- magnetite based detection.

#### **Induced E field Detection**

The first mode relates to species that are electroreceptive, the majority of which are the Elasmobranchs (Table 2). It is generally assumed that the induced E field mode of detection is used for navigation. The species that utilise this mode are considered to be either:

(a) *passive* - when the animal estimates its drift from the electrical fields produced by the interaction between tidal and wind-driven currents, and the vertical component of the Earth's magnetic field; or

(b) *active* - when the animal derives its magnetic compass heading from the electrical field it generates by its own interaction with the horizontal component of the Earth's magnetic field (Paulin 1995; von der Emde 1998).

The passive mode has been suggested to occur in the migrating flatfish *Pleuronectes platessa*, however this species may in fact use the magnetite-based mode (Metcalf *et al.* 1993).

#### **Magnetite based detection**

Magnetite deposits play an important role in geomagnetic field detection in a relatively large variety of organisms (such as birds, insects, fish and cetaceans; Kirshvink 1997). For many of these species of organism sensitivity to the geomagnetic field is associated with a direction finding ability.

Table 3 shows the magnetosensitive species that inhabit the UK coastal waters. This list is based on species that have been shown to respond directly to geomagnetic and/or magnetic fields or are close relatives in the case of some of the cetaceans and chelonians. Interestingly, no evidence was found to suggest that Pinnipeds (eg. Seals) are magnetoreceptive. Table 3 also includes reference to species not found in UK waters but which have close relatives that are native.

**Evidence from magnetic field studies**

The sandbar shark (*Carcharhinus plumbeus*) and the scalloped hammerhead (*Sphyrna lewini*) have been shown through behavioural experiments to respond to localised magnetic fields of 25 to 100  $\mu\text{T}$  (Meyer *et al* 2004). This study provides evidence that elasmobranchs can detect local changes in B field emissions against the earth's background geomagnetic field (approximately 36  $\mu\text{T}$  in this study).

The brown shrimp *Crangon crangon* has been recorded as being attracted to the B fields of the magnitude expected around wind farms (ICES 2003).

A study of the effects of exposure to static B fields on the crustaceans, *C. crangon*, *Rhithropanopeus harrisi* (round crab) and *Saduria entomon* (isopod), bivalve *Mytilus edulis* (mussel) and teleost fish *Plathichthys flesus* (flounder) showed no significant effect (Bochert & Zettler 2004). The study was conducted over several weeks and the authors note that there were suggestions of differential survival of the crustacea.

Through controlled experiments it has been shown that EMFs appear to disrupt the transport of calcium ions in cells, which may be of importance to developing embryos. B fields of 1-100  $\mu\text{T}$  have been found to delay embryonic development in sea urchins and fish (Cameron *et al.* 1985; Cameron *et al.* 1993; Zimmerman *et al.* 1990).

A high frequency AC EMF passed between two electrodes has been shown to cause significant cell damage to barnacle larvae and also caused them to retract their antennae, interfering with settlement (Leya *et al.* 1999).

**Conclusion**

Whilst the information available on magnetic fields is limited, it does suggest that potential interactions between B field emissions, of the order likely to be associated with wind farm cables, and coastal organisms could occur from the cellular through to the behavioural level.



**Table 3. List of magnetoreceptive species in UK coastal waters.**

Species	Common name	Relative occurrence in UK waters	Evidence of response to B fields
<b>Cetacea</b>	<b>Whales, dolphins &amp; porpoises</b>		
<i>Phocoena phocoena</i>	Harbour porpoise	Common	✓
<i>Tursiops truncatus</i>	Bottlenose dolphin	Common	✓
<i>Lagenorhynchus albirostris</i>	White-beaked dolphin	Common	
<i>Globicephala melas</i>	Long-finned pilot whale	Occasional	✓
<i>Lagenorhynchus acutus</i>	Atlantic white-sided dolphin	Occasional	✓
<i>Orcinus orca</i>	Killer whale	Occasional	
<i>Balaenoptera acutorostrata</i>	Minke whale		
<i>Delphinus delphis</i>	Short-beaked common dolphin	Occasional	✓
<i>Grampus griseus</i>	Risso's dolphin	Occasional	✓
<i>Physeter macrocephalus</i>	Sperm whale	Occasional	✓
<i>Megaptera novaengliae</i>	Humpback whale	Occasional	
<i>Balaenoptera physalus</i>	Fin whale	Occasional	✓
<i>Stenella coeruleoalba</i>	Striped dolphin	Rare	✓
<i>Monodon monoceros</i>	Narwhal	Rare	
<i>Delphinapterus leucas</i>	Beluga	Rare	
<i>Pseudorca crassidens</i>	False killer whale	Rare	
<i>Hyperdoon ampullatus</i>	Northern bottlenose whale	Rare	
<i>Ziphius cavirostris</i>	Cuvier's beaked whale	Rare	
<i>Mesoplodon bidens</i>	Sowerby's beaked whale	Rare	
<i>Balaenoptera borealis</i>	Sei whale	Rare	
<i>Balaenoptera musculus</i>	Blue whale	Rare	
<i>Eubalaena glacialis</i>	Northern right whale	Rare	
<i>Kogia breviceps</i>	Pygmy sperm whale	Rare	✓
<i>Lagenodelphis hosei</i>	Fraser's dolphin	Rare	
<i>Peponocephala electra</i>	Melon-headed whale	Rare	
<b>Chelonia</b>	<b>Turtles</b>		
<i>Caretta caretta</i>	Loggerhead	Common	✓
<i>Dermochelys coriacea</i>	Leatherback	Common	
<i>Chelonia mydas</i>	Green	Occasional	✓
<i>Eretmochelys imbricata</i>	Hawksbill	Rare	
<i>Lepidochelys kempi</i>	Kemp's Ridley	Rare	
<b>Teleostei</b>	<b>Bony fish</b>		
<i>Anguilla anguilla</i>	European eel	Common	✓
<i>Salmo salar</i>	Atlantic salmon	Common	✓
<b>Scombridae †</b>	Tunas & mackerels	Common	✓
<i>Pleuronectes platessa</i>	Plaice	Common	✓
<i>Salmo trutta</i>	Sea trout	Occasional	✓
<i>Thunnus albacares</i>	Yellowfin tuna	Occasional	✓

## COWRIE 1.5 Electromagnetic Fields

Species	Common name	Relative occurrence in UK waters	Evidence of response to B fields
<b>Elasmobranchii</b>	<b>Sharks, skates &amp; rays</b>	All Elasmobranchii, Holocephali and Agnathans possess the ability to detect magnetic fields (for species see Table 2. Electroreceptive species list)	
<b>Holocephali</b>	<b>Chimaeras</b>		
<b>Agnatha</b>	<b>Jawless fish</b>		
<b>Crustacea †</b>	<b>Lobsters, crabs, shrimps &amp; prawns</b>	<i>Specific cases non-UK</i> Decapoda: <i>Crangon crangon</i> (ICES 2003) Isopoda: <i>Idotea baltica</i> (Ugolini & Pezzani 1995) Amphipoda: <i>Talorchestia martensii</i> (Ugolini 1993); <i>Talitrus saltator</i> (Ugolini & Macchi 1988)	
<b>Molluscs †</b>	<b>Snails, bivalves &amp; squid</b>	<i>Specific case non-UK</i> Nudibranch: <i>Tritonia diomedea</i> (Willows 1999)	

† = evidence of magnetic response in species outside UK waters.

### Data Sources

[In addition to sources from review]

#### **Cetacea**

Atlas of cetacean distribution in north-west European waters. Eds Reid, J.B., Evans, P.G.H. & Northridge, S.P. (2003) Joint Nature Conservation Committee, Peterborough. Whale and Dolphin Conservation Society

<http://www.wdcs.org/dan/publishing.nsf/allweb/1C86991EC66F8D2C80256929003DEAAC>

Joint Nature Conservation Committee <http://www.jncc.gov.uk/page-2713>

Scottish Natural Heritage

[http://www.snh.org.uk/trends/trends\\_notes/pdf/Marine%20species/Cetaceans.pdf](http://www.snh.org.uk/trends/trends_notes/pdf/Marine%20species/Cetaceans.pdf)

North Sea Bird Club, University of Aberdeen

[http://www.abdn.ac.uk/nsbc/mar\\_mammals.hti](http://www.abdn.ac.uk/nsbc/mar_mammals.hti)

#### **Chelonia**

British Marine Life Study Society <http://www.glaucus.org.uk/turtles.htm>

Marine Conservation Society <http://www.mcsuk.org/Turtles/turtlesuk/turtleuk.htm>

Howson, C.M. & Picton, B.E. (1997) *The Species Directory of the Marine Fauna and Flora of the British Isles and Surrounding Seas*. Ulster Museum & The Marine Conservation Society

## **7 Collation of available information & literature review – Industry**

To address the review of electromagnetic fields in relation to industry we undertook a consultation exercise with developers throughout the UK, which was supported by consultation with scientists, consultants and developers in Europe. This section presents the results of these consultations and also provides information on recent developments in our understanding of electromagnetic fields, including EMF modelling undertaken on behalf of Kentish Flats offshore wind farm and other potential anthropogenic sources of EMFs in the marine environment. There is a brief assessment of the potential significance of these newly identified EMF sources for sensitive marine organisms and a summary of key gaps in our knowledge of EMFs in the marine environment.

### **7.1 Consultation with Industry**

There were four objectives of the consultation exercise:

1. To inform an assessment of the distribution of (potentially) electrically and magnetically sensitive species of interest within each of the main areas of offshore wind farm development (North West, Thames and Wash & East Coast, plus any Round 1 sites outside these areas) (i.e. a 'sensitivity assessment');
2. To support the separate review by Econnect Ltd of cabling strategies adopted by the various offshore wind farm developments;
3. To learn of any experiences concerning possible effects of sub-sea cables on fish around the first constructed wind farms;
4. To provide a central, up to date source of information on the position of the industry with respect to the environmental significance of electromagnetic and induced electrical field effects, including actual and planned monitoring.

A list of contacts for each developer of Round 1 and Round 2 offshore wind farms in the UK was obtained from the Crown Estate. A consultation request (Appendix 7) was sent on 19 November 2004. The information requested of developers was as follows:

- copies of scoping reports, environmental statements and, in particular, supporting studies (i.e. technical reports and data) by consultants on fish, fisheries and/or significance of electromagnetic fields;
- cabling specifications: maximum voltages and currents, including phase information; cable dimensions and total length of cabling; cable materials and properties (conductivity, dielectrical constant and permeability); burial depth and cable layout (including separation distances of cables to shore);
- details of any specific technical information on electromagnetic fields, including predicted magnetic and induced electric field strengths;

## COWRIE 1.5 Electromagnetic Fields

- details of any monitoring requirements relating to either fish or electromagnetic fields (e.g. FEPA conditions, if relevant) and current or anticipated approach to that monitoring.

Information received from individual developers was then reviewed and is summarised in Sections 7.1.1 to 7.1.3.

### **7.1.1 Summary of Industry Information Reviewed**

The following information was received through the consultation exercise (Table 4), which was targeted at all UK Round 1 and 2 offshore wind farm development.

**Table 4. Summary of responses to consultations requests.**

Site	Round 1/2	ES/ Scoping viewed	Additional Information Received/Available	NOTES
Barrow	1	no		
Burbo	1	ES		CMACS project- no additional info requested
Cromer	1	ES		
Gunfleet Sands	1	ES		
Inner Dowsing	1	ES		
Kentish Flats	1	ES		CMACS specialist EMF project- additional info on monitoring requested
Lynn	1	ES		Lynn was surveyed with Inner Dowsing as one project
North Hoyle	1	ES	<ul style="list-style-type: none"> <li>• monitoring programme</li> <li>• cable specifications</li> </ul>	CMACS project- no additional info requested
Ormonde	1	no		
Rhyl Flats	1	-		Project on hold
Robin Rigg	1	ES	<ul style="list-style-type: none"> <li>• Planned cable specifications</li> <li>• CPA consent conditions</li> <li>• Monitoring plan</li> </ul>	
Scarweather Sands	1	no		
Scroby Sands	1	ES		Received ES and inter-array cable layout arrangements
Shell Flats	1	no		
Teeside	1	ES		
Docking Shoal	2	S		
Dudgeon East	2	-		Not yet at scoping stage
Greater Gabbard	2	S		CMACS project- no additional info requested
Gunfleet Sands li	2	no		
Gwynt Y Mor	2	S		CMACS project- no additional info requested
Humber Gateway	2	no		
Lincs	2	S		
London Array	2	S		CMACS project- no additional info requested
Race Bank	2	-		Not yet at scoping stage
Sheringham Shoal	2	no		Requested that we sign a confidentiality agreement
Thanet	2	-		Not yet at scoping stage
Triton Knoll	2	-		Not yet at the scoping stage (stated that CEFAS iSEAS database was being used)
Walney	2	S		
West Duddon	2	-		
Westermost Rough	2	-		

### 7.1.2 Sensitivity Assessment (distribution of electrically and magnetically sensitive species)

The following Environmental Statements and Scoping Reports were reviewed:

**Table 5. Environmental Statements (ES) and Scoping Reports Reviewed in the Study**

<b>OWF (Round 1/2)</b>	<b>Scoping/ES</b>	<b>Date</b>
Scroby Sands (1)	ES	January 2001
North Hoyle (1)	ES	February 2002
Robin Rigg (1)	ES	May 2002
Kentish Flats (1)	ES	August 2002
Burbo Bank (1)	ES	September 2002
Cromer (1)	ES	October 2002
Gunfleet Sands (1)	ES	2002
Greater Gabbard (2)	Scoping	February 2004
Teeside (1)	ES	March 2004
Docking Shoal (2)	Scoping	August 2004
Walney (2)	Scoping	September 2004
Lincs (2)	Scoping	October 2004
GwyntyôMor (2)	Scoping	November 2004
London Array (2)	Scoping	March 2003
Inner Dowsing (1)	ES	2002
Codling Bank (Ireland)	ES	2003

A summary of the main aspects within the Environmental Statements or Scoping Reports for each of the three Round 2 strategic development areas follows:

#### **North West**

The Walney scoping report identified several species of fish of conservation importance: basking shark, angel shark, common skate (this species probably does not need consideration as it is recorded as extirpated in the Irish Sea). Also mentioned were species recorded in the area of the wind farm in the EIA: spurdog, thornback ray and basking shark. Electromagnetic effects were postulated to be insignificant for sensitive species.

The North Hoyle ES recognised thornback rays, spurdog, dogfish and tope as electrosensitive species likely to be found in the vicinity of the wind farm. The Burbo Flats ES highlighted the same species as the North Hoyle ES with the addition of

## COWRIE 1.5 Electromagnetic Fields

basking shark, blue shark, thresher shark, mako, porbeagle and electric rays as rare and vagrant species in the Irish Sea. The Gwynt-y-Môr scoping report also mentioned basking, blue, thresher sharks, mako and porbeagle but made no specific comment on the effect of wind farms on these fish. The presence of thornback rays in Liverpool Bay was acknowledged in this latter report but assessment of the effect of electromagnetic and induced electrical fields has been left until the environmental statement for that site.

The Robin Rigg ES listed the following elasmobranchs recorded from the Solway Firth: thornback ray, stingray, electric ray, dogfish, tope, basking, blue, thresher shark and porbeagle. Also considered were “the eight other species of ray” (probably blonde rays, spotted rays etc.), smooth hounds and angel sharks.

### **Wash & East Coast**

The Lincs Scoping Report considered elasmobranchs (no reference to particular species), salmonids and eels but did not attribute any specific impact to them nor did it discuss their specific biology in relation to wind farms.

The survey work (trawls) for the Inner Dowsing ES did not catch any elasmobranchs and therefore they were not discussed, likewise eels and salmonids were not caught and therefore not discussed. Basking shark was mentioned as a CITES and IUCN red data list species.

The Cromer ES (2002) identified thornback ray, nursehounds, dogfish, spurdog and tope as present in the region of the wind farm. Sea trout were also mentioned.

The Teesside ES (2004) assumed skates and rays to be present in the area as these fish are targeted in fisheries. Also present were dogfish, which are caught as bycatch in the longline fishery. Similarly, the Docking Shoal scoping report (2004) mentioned skates and rays as part of the local fisheries and the only specifically included elasmobranch was the basking shark.

The Scroby Sands ES (2002) referred to the CEFAS 1981-1997 young fish survey when considering species caught in that region. It appears that dogfish, thornback ray, blonde ray, small-eye ray, spotted ray, undulate ray, starry ray and smooth hounds are all present in this region.

### **Thames**

Gunfleet mentioned a thornback ray fishery on the sands and also cited the CEFAS young fish study of 1981-1997 which found thornback and starry rays in the Thames region.

Kentish Flats mentioned no specific elasmobranchs that may be affected by electromagnetic or induced electrical fields in the area of the wind farm. Both of these reports did mention the presence of salmonids and eels within the area of the wind farms but cited that salmon naturally avoid the wind farm site due to their migration route. It was postulated that eels and trout would avoid the wind farm during the construction period due to noise of construction.

## COWRIE 1.5 Electromagnetic Fields

Six species of elasmobranch were recorded in the region of the Greater Gabbard Bank and were also mentioned in the London Array scoping report: spurdog, tope, dogfish, angel shark, cuckoo ray and thornback ray. Also noted as occasionally present in the area were porbeagle, thresher and basking sharks.

### Industry Position on Magnetic and Induced Electrical Fields

#### General

Most of the environmental statements that considered magnetic and induced electrical fields suggested that the wind farm development would not influence the behaviour of sensitive species because cable burial would mitigate for any adverse effects<sup>1</sup>. One exception was the Gunfleet Sands ES (2002), which cited lack of evidence for a firm conclusion. Scroby Sands ES, (2001) and Codling Bank ES (2003) did not mention electromagnetic or induced electrical fields at all. Due to the position of the proposed wind farm in the Solway Firth, there was some concern in the associated ES (Robin Rigg ES, 2002) that the cable may be periodically exposed by shifting sandbanks. In such a situation it was postulated that the cable would repel thornback rays and possibly prevent their migration to Allonby Bay where this species is known to breed. However, the significance of electromagnetic and induced electrical fields was still considered to be low because cable exposure was considered very unlikely.

#### Induced Electrical Fields

There was some discrepancy in Environmental Statements concerning the magnitude of electrical field that may repel elasmobranchs, reports variously quote figures of 10 $\mu$ V/cm, 1000 $\mu$ V/cm and 1000  $\mu$ V (sic). This is most likely related to confusion over the units of measurement.

There was general agreement in environmental statements that a field of sufficient strength to cause avoidance behaviour in elasmobranchs will only occur within 10-20 cm of the cable and therefore burying the cable and covering with boulder armour is enough protection. One report reasoned the electromagnetic field present at the sediment surface to be less than background (Kentish Flats ES, 2002).

The Inner Dowsing ES (2002) contained the following statement on EMF:

“The cable will be a high voltage alternating current system with all three cores in one cable with an overall screen resulting in no electric or magnetic fields as the electric fields are contained within the cable (Pirelli email, 2002). As a consequence of the cable design, particularly the armoured insulation and depth to which it will be buried, the electrical field is expected to be zero.”

A similar statement can be found in the Robin Rigg ES (2002) which predicts that around the parts of the cable buried by directional drilling there will not be an electric field at the sediment surface.

---

<sup>1</sup> See comments in Section 7.5.



## COWRIE 1.5 Electromagnetic Fields

Other Environmental Statements (Burbo Flats ES, 2002; North Hoyle ES, 2002; Robin Rigg ES, 2002; Teesside ES, 2004) suggested burial of the cable as a mitigation for the electromagnetic field at the sediment surface. This was because of the possibility that sharks and rays could be attracted to the cable as the electric field might be similar to the field surrounding prey organisms. Subsequently, however, these reports cited insufficient evidence to confirm this as an issue. One report stated that an electromagnetic field or an induced electrical field will not affect the ability of a shark or ray to detect prey but made no mention of cable burial (Cromer ES, 2002).

The work of Gill & Taylor (2001) has been cited in most of the scoping reports and environmental statements. The results of this research are not always utilized effectively: Based on Gill & Taylor (2001) one environmental statement postulated that rays are less likely to be affected by electromagnetic and induced electrical fields than the dogfish used by Gill & Taylor because their electro-sensory pores are more spread out on their snout than on dogfish and therefore they are less sensitive (Cromer ES, 2002)<sup>2</sup>. The Teesside ES (2004) also summarized Gill & Taylor (2001) but did not use this information to postulate possible impacts of offshore wind farm cables on the species of elasmobranch found in that region.

### **Magnetic Fields**

Cetaceans, salmon and anguillid eels have received attention with respect to B fields around wind farms as all these organisms are widely considered to use the Earth's magnetic field to navigate during migration. The magnetic fields generated around wind farms are postulated to be a potential source of disruption to the migration of whales, salmon and eels. However, since migration generally occurs in open water and away from the seabed, wind farms are reported to be unlikely to have a detrimental effect on fish and whale migration.

Impacts of the wind farm cables on salmon, sea trout and European eels were considered in all of the environmental statements and scoping reports in the region of Liverpool Bay but focussed on cable burial and resulting suspended sediment impacts rather than magnetic fields. There are several buried cables in existence in that region (Dee estuary) that were considered not to have affected eel or salmonid migrations in the past. Salmonids and eels were also considered in the Robin Rigg ES (2002) but no effect of magnetic fields was predicted because they are assumed to use olfaction rather than the Earth's magnetic field to navigate once they are close inshore.

### **7.1.3 Cabling Strategies**

The conclusions of the Econnect study (cf. Section 8.1) are generally supported by the information supplied by industry consultees. There is widespread standardisation in cabling strategy across the industry and developers are selecting

---

<sup>2</sup> There is no biological basis to this statement; in fact the opposite is true. Species with greater spacing, such as skates and rays, have longer electrosensory canals which in a uniform E-field provides greater sensitivity.

## COWRIE 1.5 Electromagnetic Fields

three core 33kV cables for intra-array connections and 132 (or possibly 245kV) cables for grid connection to land.

One or two developers may consider use of 74kV intra-array cabling; however, our current understanding is that such an option is unlikely to be installed.

It is possible that Round 2 development will employ offshore sub-stations incorporating switchgear, transformers etc. to convert the voltage of the wind turbine collection array cabling to the array to shore sub-sea cable(s) voltage. This means it is likely that a number of cables will come together in relatively close proximity (less than 10m) at offshore sub-stations. This will have implications for EMFs which are considered further in Section 7.2.

## 7.2 Recent Advances in understanding of EMFs

### 7.2.1 EMF Modelling

EMF modelling has recently been undertaken by the University of Liverpool as part of a CMACS study at the Kentish Flats offshore wind farm site (CMACS 2004). The modelling was conducted in the same manner as the COWRIE Phase 1 work. The Kentish Flats model was for two 33 kV cables with contrasting conductor sizes, 500 mm<sup>2</sup> and 185 mm<sup>2</sup>, carrying maximum current loads of 530A and 265A respectively. The phase 1 COWRIE study (CMACS 2003) modelled a single 132kV XLPE three-phase submarine cable carrying 350A in each conductor. The only differences between the two models are the conductivity constant used for seawater (full seawater at 5 s/m for COWRIE 1, 4 s/m at Kentish Flats). Other differences (e.g. in sheath conductivity, operating voltage, current load etc.) relate to cable specification and operation. Tables 6 and 7 detail the relevant material electromagnetic properties and major parameters of the two cables.

**Table 6.** Material electromagnetic properties of both submarine cables at Kentish Flats.

	Relative Permittivity $\epsilon_r$	Conductivity $\sigma$ (s/m)	Relative Permeability $\mu_r$
Conductor (Copper)	1.0	58, 000, 000	1.0
XLPE	2.5	0.0	1.0
Sheath (Copper/Semi)	1.0	1, 000, 000	1.0
Armour (Steel wire)	1.0	1,100, 000	300
Seawater	81	4.0	1.0
Sea bed	25	1.0	1.0

## COWRIE 1.5 Electromagnetic Fields

**Table 7.** Major parameters of Cable 1 and Cable 2 at Kentish Flats.

	Cable 1	Cable 2	Note
Outer diameter (mm)	128.7	105.0	10 mm steel armour
Conductor size (mm <sup>2</sup> )	500	185	Copper
Conductor diameter (mm)	28.9	17.9	
Metallic Screen (mm)	47.2	36.2	Copper
Max Voltage (kV)	33	33	
Max Current (A)	530	265	Each cable

For Kentish Flats cable 1 the magnitude of the current density both on the 'skin' of the cable (i.e. within millimetres) and in the seabed directly above the cable is  $0.00004\text{A/m}^2 = 40\mu\text{A/m}^2$ . This can be approximated to E field strength of  $40\mu\text{V/m}$  (assuming a seabed conductivity of 1 Siemen per metre [S/m]). The E field in the seabed dissipates rapidly to only 1 or 2  $\mu\text{V/m}$  within a distance of approximately 10m from the cable.

The maximum magnitude of the current density at the interface between the seabed and seawater is about  $0.00001\text{A/m}^2 = 10\mu\text{A/m}^2$ . This means that the maximum E field strength generated by Cable 1 into the sea is  $2.5\mu\text{V/m}$  (assuming a seawater conductivity of 4 S/m, i.e. fully marine).

The same simulation was conducted for Cable 2. Table 8 summaries the major EMF parameters generated by Cable 1 and Cable 2 when they are buried 1.5m into the seabed.

**Table 8.** Major EMF parameters of Cable 1 and Cable 2 at Kentish Flats (cable buried at 1.5m depth).

	Cable 1	Cable 2	Note
Max B field in seabed ( $\mu\text{T}$ )	1.5	0.9	Assuming $\sigma = 1$
Max current density in seabed ( $\mu\text{A/m}^2$ )	40	25	
Max iE field in seabed ( $\mu\text{V/m}$ )	40	25	
Estimated average iE field in seabed ( $\mu\text{V/m}$ )	20	12.5	*1
Max B field in sea ( $\mu\text{T}$ )	0.03	0.02	Assuming $\sigma = 4$
Estimated average B field in sea ( $\mu\text{T}$ )	0.015	0.01	*1
Max current density in sea ( $\mu\text{A/m}^2$ )	10	6	
Max iE field in sea ( $\mu\text{V/m}$ )	2.5	1.5	

\*1 - assumes that average generating conditions load cables with 50% of current at maximum output.

This modelling provides for a useful comparison between two of the commonly considered cable specifications for offshore wind farms, 132kV and 33kV (cf. Section 8.1). The predicted maximum iE field in the water for either of the Kentish Flats cable (2.5  $\mu\text{V}/\text{m}$ ) is substantially lower than the maximum iE field predicted by modelling in the CMACS (2003) COWRIE 1.0 study for 132kV, 350 Ampere three phase cable buried at 1m which was 91 $\mu\text{V}/\text{m}$ . However, both values are within the range which may be detectable by elasmobranchs and potentially attractive to such species (0.5 – 100  $\mu\text{V}/\text{m}$ ).

The Kentish Flats modelling also provided the first assessment of the resultant B and iE fields when a wind farm was operating at below maximum capacity (i.e. at average wind speeds). There was a linear relationship between current load and resultant B and iE fields with both fields directly proportional to current load such that halving the current halved the resultant fields.

In addition to new information on EMFs from an alternative design of cable, there is now a recognition that cable networks with EMFs in close proximity to each other (e.g. as may be the case at sub-station gathering points where cable may be less than 10m apart) may need site specific analysis due to the interaction of the fields as a single system. Normally, the maximum magnitude of the EMF at any given point is inversely proportional to the distance from the power cable. However, 50Hz sub-sea cables have long wavelengths and when such cables are closely placed the fields may be combined constructively (in phase) resulting in larger fields in these areas. We understand that the effect for cables in close proximity will be to combine the fields additively (Yi Huang, pers. comm.). This could result in iE fields of several hundred  $\mu\text{V}/\text{m}$  if cables are not buried or fields otherwise dampened when cables come together at sub-stations.

### **7.3 Other Sources of Magnetic and Electrical Fields**

The offshore wind farm industry is a new and rapidly developing sector and needs to use very large amounts of electrical cabling. The recognition that this cabling has the potential to interact with EMF sensitive organisms has led to the requirement for an improved understanding of the interaction and the current review. There are, however, anthropogenic sources of electric and magnetic fields that have been present in the marine environment for many years. These include: telecommunication cables, fibre optic and coaxial; heated pipelines; and other power cables.

Such existing offshore cables and pipelines have varying potential to produce electrical and/or electromagnetic fields. The following provides a brief overview.

#### **7.3.1 Submarine telecommunications cables**

Early telecommunication cables were of a coaxial design, i.e. with an outer metallic return conductor surrounding an inner core conductor. Most modern long distance telecommunication cables consist of optical fibres rather than wires. Such cables may require a power supply to signal amplifiers (repeaters) which boost the signal at

## COWRIE 1.5 Electromagnetic Fields

various points along the length of the cables. It has already been noted (Section 6.3.1) that electric fields from a particular telecommunications cable were within the range 1 to 6.3 $\mu$ v/m at 1m, which were lower than, but comparable to, the iE field magnitudes predicted by modelling in the COWRIE 1 study).

Some recent telecommunication cables are understood to use optical amplification without the need for the electrical regenerator in the repeater. It is anticipated that this latter system and short length fibre optic cables without repeaters would have no associated electric or magnetic fields; all other designs of submarine telecommunication cable have the potential to produce magnetic and/or electric fields in the marine environment.

The most comprehensive information on existing UK/NE Atlantic sub-sea cables not specifically associated with wind farms is Geocable GIS which can be obtained through Global Marine Systems. The data belongs to The United Kingdom Cable Protection Committee (UKCPC), an international forum of administrations and commercial companies that own, operate or service submarine telecommunications cables in UK waters. The principal goal of the UKCPC is the promotion of marine safety and the safeguarding of submarine telecommunications cables from man-made and natural hazards.

The Geocable GIS database is a commercially available product the cost of which was outwith the scope of the present project. However, the UKCPC also provide a free set of the base data which is administered by Seafish Kingfisher through their KIS-CA project and cable awareness.

One of the communication media available through KIS-CA are charts which show major cable in-service routes and other physical details (e.g. repeaters, splices, etc.), together with emergency procedures and contact numbers. The charts are produced and distributed, free of charge to fishers, and are updated annually to improve cable awareness. In addition the data are also available in electronic format and include out-of-service analogue and telegraphy cables which still pose a threat to fishing safety (<http://www.kisca.org.uk/charts.htm>).

The waters covered by the KIS-CA project are extensive - the North Sea, English Channel (La Manche), Bristol Channel / Southwest Approaches, Irish Sea and West of Scotland (i.e. ICES Areas IV, VII and VI) - and therefore include cables between the coasts of Norway, Denmark, Germany, Netherlands, Belgium, France, Ireland and the UK (see Appendix 8).

Reviews of existing activities under the DTI SEAs (strategic environmental assessments) programme also provide a summary of locations of existing submarine telecommunications cables for the Thames and Wash & East Coast areas ([DTI SEAS](#)).

The Thames area has some cable infrastructure with five main cables crossing through the Thames Round 2 area into Margate and other cables present within or close to this area (Appendix 8). The North West area also has some major cable infrastructure within the Liverpool Bay Round 2 area (Appendix 8). This area also has a power line joining the Isle of Man with the mainland near Blackpool. There is

## COWRIE 1.5 Electromagnetic Fields

much less existing telecommunication cabling within the Wash & East Coast area (1 cable landing at Sheringham; Appendix 8). Other areas of the UK coast have a greater number of cable routes particularly the south west approaches and the eastern English Channel (See Appendix 8).

Long-haul telecommunications submarine cables are understood to be powered by high voltage DC power plants, or power feed equipment, at each end which furnishes 8 to 15 Kilovolts DC across the system at currents of up to 1.6 Amperes. This electricity powers the system's repeaters (from: [www.diveweb.com/offshore/features/uw-su97.02.htm](http://www.diveweb.com/offshore/features/uw-su97.02.htm)). We were not able to obtain any detailed information on the likely magnitude of electric or magnetic fields.

### 7.3.2 Pipelines

Oil and gas pipelines may be heated to prevent wax and hydrate formation which can reduce flow and potentially block pipelines. Various heating options are available, including chemical injection (where heat is given off by an exothermic reaction), small bore hot water pipes within the main pipeline and electrical heating.

Electrically heated pipelines operate either by direct heating or induction. With induction heating, a conductor is coiled around the pipeline, the current in the conductor sets up a magnetic field which induces a current directly into the wall of the (metallic) pipeline. The current flowing through the pipeline then has a heating effect due to the resistance of the pipe material.

With direct heating a voltage is applied directly to the pipeline, the resulting current returns to the source by flowing through either a combination of the seawater and the pipeline, or a separate cable.

Voltages and currents are understood to vary widely. In the majority of cases the cables are believed to be single phase, high current and unscreened/unarmoured. The magnitude of B and E fields produced is unknown but would likely be largest with directly heated cables.

The DTI Energy Report ([www.dbd-data.co.uk/bb2001/](http://www.dbd-data.co.uk/bb2001/)) provides a detailed database of the location of existing oil and gas pipes. We were not, however, able to obtain any information about how common electrically heated pipelines are, whether any such pipelines cross any of the wind farm development areas, and what environmental assessments and monitoring has been undertaken in respect of electric and magnetic field effects.

### 7.3.3 Other Power Cables

There are other existing power cables that run between oil and gas installations. In addition, cables are known to join islands to the mainland power network or run across estuaries and bays (cf. Phase 1 COWRIE EMF study where an unquantified electric field was noted in the Clwyd estuary, North Wales). No information was

found relating to these smaller and very localised cable sites, although some of the information may be available through the Geocable GIS database.

Future offshore renewable energy developments, including wind, wave and tidal power schemes, will also require submarine power cables which will add to the expanding length of cables in UK coastal waters.

### ***7.4 Inferring effects of existing sub-sea cables on EM sensitive species***

We have summarised the geographic information that was available. In order to assess whether there are any existing links between cables, pipelines and EM sensitive species we focussed on the elasmobranchs in coastal waters of England and Wales. We accessed the CEFAS fisheries database (<http://map2.cefasdirect.co.uk/isea/>), DEFRA data from the Irish Sea and catch data from the Isle of Man fisheries. We also consulted published fishery related studies to qualitatively assess whether there was any evidence for an association between E-sensitive elasmobranch species and the existing cable network around the England and Wales coast.

Data from early in the 20<sup>th</sup> century compared with catch data from the 1980s onwards show that elasmobranch populations have drastically declined. These data are limited and the only areas fished which also have known cable routes running through them are in the Irish Sea. We have no information on when the cables were installed but assumed that for most it was post-1910. Whilst the data show a decline in the elasmobranchs the main cause of this is attributed to fishing and habitat degradation. It is not possible to determine whether EMFs played any part in this decline.

The most recent fisheries data show that significant proportions of the English and Welsh ray population (see Appendix 9 – note species not defined) inhabit the eastern Irish Sea, the Bristol Channel and the Thames Estuary. These are areas that have major cables running through them (see Appendix 8). The same data show that there are also significant proportions of the ray population in Cardigan Bay where there are no cables.

We could find no suitable data for Scottish waters and the limited data available from English and Welsh waters demonstrated that it would be difficult to specifically show an association between EMFs and elasmobranch distribution and abundance without knowing the precise location of the fishing survey and the cables that run through the survey area. A more detailed and quantitative analysis was out side the scope of this review.

### ***7.5 Summary and Information Gaps***

It is clear from the information received from the offshore wind industry, and in particular following review of Environmental Statements, that the issue of electromagnetic (both B and iE field) effects on electrically and magnetically

## COWRIE 1.5 Electromagnetic Fields

sensitive species has not been addressed in a consistent manner and that there are a number of important misconceptions. Key misconceptions include the assertions that cable burial will work to mitigate iE and B field effects and that there will be no externally detectable electric fields generated by industry standard submarine power cables.

The actual conclusion of the Phase 1 COWRIE EMF study was that cable burial was ineffective in 'dampening' the B field (and resultant iE field); however cable burial to a depth of at least 1m is likely to provide some mitigation for the possible impacts of the strongest B field and induced E fields (that exist within millimeters of the cable) on sensitive fish species, owing to the physical barrier of the substratum. It is worth noting at this point that EMFs of a magnitude that could be detected by sensitive marine animals would be produced by industry standard power cabling, even if buried to several metres. It is possible that, for certain cable specifications, burial might result in maximum iE fields dropping below the threshold between attraction and repulsion for elasmobranchs (100  $\mu\text{V}/\text{m}$ ); however, this can not be known for specific cabling arrangements without appropriate modelling or field measurements.

The main reason for the inconsistency in approach, however, is the lack of clear scientific guidance on the significance of effects on receptor species (if any). The industry has, in general, made efforts to consider electromagnetic field effects and is to be applauded for doing so. Advances in scientific knowledge are clearly required and Sections 10 and 11 contain proposals for appropriate studies.

Following the review of industry information we have identified a number of significant gaps in knowledge regarding sources of electrical and magnetic fields in the marine environment. These relate to information on possible future cabling strategies for offshore wind farms (and other offshore renewable developments) and other (existing) sources of B and E fields and are summarised as follows:

- likely electric and magnetic field strengths associated with each existing source (i.e. telecommunication cables, non-wind farm power cables and pipelines);
- likely electric and magnetic field strengths associated with new-design 245kV submarine power cables that may be used at Round 2 offshore wind farm sites;
- likely electric and magnetic field strengths associated with offshore sub-stations planned for the larger Round 2 wind farms.
- frequency and duration of electrical heating of oil and gas pipelines;
- precise location of telecommunication cables;
- precise location of other submarine power cables.

These information gaps are significant not only because we need to understand the extent of anthropogenic B and E fields before attempting to plan and interpret studies to assess their ecological effects, but also because all anthropogenic sources of B and E fields should be considered as part of cumulative impact assessments for proposed offshore developments that may have electric and/or magnetic field effects.

The gaps need to be filled so that direct studies of E and B field effects (cf. Sections 10 and 11) may be fully interpreted in relation not only to offshore wind farm cabling but other sources of such fields.



## COWRIE 1.5 Electromagnetic Fields

It is believed that all these gaps can be relatively easily addressed through a combination of modelling (along the lines of that undertaken for the COWRIE Phase 1 project (CMACS 2003) and consultation/information searching to update our understanding of the design of other offshore electrical infrastructure.

## **8 Update of COWRIE Phase 1 Offshore Wind Farm Cabling Strategy and EMF Modelling**

In the Phase 1 COWRIE EMF study we provided a review of the cabling strategy adopted by the UK offshore wind farm developers. Modelling of likely EMFs was based on cable specification identified as likely to represent an industry-standard approach.

Here, we present an update on UK offshore wind farm design strategy and also summarise our response to questions received following release of the phase 1 report.

### ***8.1 UK Offshore Wind Farm Design Strategy***

#### **8.1.1 Introduction**

Econnect Ltd have updated their review of design strategy, as it relates to submarine power cables and associated power management systems. Econnect's remit was as follows:

- to update the phase 1 review, taking into account the larger scale wind farms planned under Round 2 and any advances in technology available to developers.

The full report is provided in Appendix 10. A summary of the main findings is provided in the following section.

#### **8.1.2 Summary of Econnect Report**

The main conclusions of the report were as follows:

- For many of the Round 2 wind farms, connection using an AC transmission system with 3-core 132kV sub-sea cable(s) with 200MW capacity may be the most cost-effective solution, despite the extra number of cables and offshore array collection platforms associated with these solutions.
- Cables within wind farm arrays will be 33kV.
- 3-core 245kV cables currently under development could be employed to maximise the power transfer capacity of AC shorelink transmission systems.
- The use of HVDC shorelink transmission only becomes cost effective where a project is a significant distance from the coastline and where large amounts of power need to be transferred.

Since receipt of the draft final Econnect report it has come to our attention that some developers are considering 72 kV cabling within offshore arrays (London Array

## COWRIE 1.5 Electromagnetic Fields

Environmental Statement June 2005). The Econnect report suggests that this is unlikely; Econnect have commented as follows:

*increasing the voltage level to 72kV within the array cabling system would increase the cost of the sub-sea cables, protection systems, and step-up turbine generator transformers with little advantage to the transferred power level since the array cabling system is normally arranged in strings and therefore the cable thermal loading of some part of the string would normally be low. (Adel Jawad, pers. comm.)*

### **8.2 Responses to Questions following COWRIE Phase 1 Report**

A number of questions were received relating to the modelling approach used by CIMS to predict electromagnetic and electrical fields associated with submarine power cables for offshore wind farms.

The questions raised are technical in nature and we do not consider that there need be any re-evaluation of the ultimate conclusions from the phase 1 EMF modelling work. The questions are summarised and responses detailed in Appendix 11.

## 9 Identification and Assessment of Potential Impacts

### 9.1 Overview of Available Information

Based on the review of available information it is clear that there is a significant gap in knowledge concerning EM sensitive species and undersea cables (in general). The evidence that does exist is summarised below and is based on studies that bear a direct relation to power cables. We have not included studies that may suggest some indirect relevance but acknowledge that they may become relevant in the future as our understanding is improved (see Gill, 2005). Using the information from the previous sections we present the main aspects to consider in relation to offshore wind farm related EMFs and potential impacts. We also provide a list of species that require priority consideration.

#### *Direct response to Electric fields*

Marra (1989) – evidence of shark bites on submarine optical telecommunications cable. The cable was associated with two forms of induced electric fields: a 50 Hz E field of  $6.3\mu\text{v}/\text{m}$  at 1m caused by the power feed to the cable and another of  $1\mu\text{v}/\text{m}$  at 0.1m resulting from the sharks crossing the B field emitted by the cable. Subsequent behavioural tests in the laboratory and at sea were inconclusive, however cable reinforcing reduced the incidence of shark bites damaging the cable. The E fields produced by this cable are comparable with the  $91\mu\text{v}/\text{m}$  at 1m modelled and measured for industry standard 50Hz high voltage offshore wind farm cable (see COWRIE 1 for details).

Gill & Taylor (2001) – limited laboratory based evidence that the benthic elasmobranch (*Scyliorhinus canicula*) avoids DC E fields at emission intensities similar to those predicted from offshore wind farm AC cables. The same fish were attracted to DC emissions at levels predicted to emanate from their prey.

Poddubny (1967) – observed that the electroreceptive sturgeon (*Acipenser gueldenstaedtii*) veered away from high voltage overhead lines (110kV) crossing above the water. The sturgeon also swam slowly near to the lines and swam faster once past them.

#### *Direct response to magnetic fields*

Meyer *et al.* (2004) – first demonstration that elasmobranchs can detect B fields in the range 25-100  $\mu\text{T}$  against the ambient geomagnetic field (approximately 36  $\mu\text{T}$ ).

Westerberg (2000) – demonstrated some response by European Eels (*Anguilla anguilla*) to magnetic emissions from HVDC cables.

ICES (2003) – prawn (*Crangon crangon*) showed some attraction to B fields associated with a wind farm cable.

Therefore for both B and E fields associated with offshore wind farms we need to:

- Identify the species most likely to interact with the EMFs. This will vary between species according to their habits, conservation status and needs to consider different life stages
- Definitively determine whether these species will be affected
- assess the potential significance of any effects
- specifically consider the significance of larger (Round 2) offshore wind farm developments;
- specifically consider cumulative impacts of adjacent developments, not just wind farms.

## **9.2 Assessment of Electromagnetic Fields Impact**

### **9.2.1 Induced Electrical Fields**

Benthic species such as skates/rays and catsharks/dogfish use electroreception as their principal sense for locating food. More open water (pelagic) species, such as tope, porbeagles or salmonids, may encounter E fields only during specific periods such as the reproductive season; early life stages in shallow water nurseries or migration. Hence, the potential for an impact is considered highest for species that depend on electric cues to detect benthic prey and mates, early life stages that use electroreception to detect predators or migratory routes which take them into shallow coastal waters.

As the potential significance for electrosensitive species of anthropogenic electrical fields associated with wind farms is uncertain we need to know:

- whether electrosensitive species can detect the induced fields emitted by the cables;
- the consequences, if any, for the species of concern;
- if any effects are similar for individuals (e.g. of different age or sex) within a species population;
- if an effect is demonstrated then it is important to determine whether the effect is attraction or avoidance of the EMF by the receptor species.

This last point is fundamental to any understanding of what a response to EMFs means to the organisms that respond. If attraction to iE fields from the cables results then we would predict indirect impacts for individual animals investigating the iE fields assuming that they are associating the fields with food and therefore actually wasting time and energy doing so. A repulsive field could have a direct impact by actively repelling animals, thereby interrupting normal behaviour and potentially excluding habitat from use. It should be noted, however, that there is currently no evidence that either attraction or repulsion due to anthropogenic electric fields will have an effect on fish or other receptor species.

## COWRIE 1.5 Electromagnetic Fields

We do not currently understand the relative significance of the cable route which cuts across a long length of seabed (30 km or more for the more offshore Round 2 sites) compared to the array with a network of cables over a wide area (>200km<sup>2</sup> for some Round 2 developments). If, as predicted in Section 7.2.1, an array of lower rating cables produces an additive E field then the electrical environment for electroreceptive species in spatial terms could be different to that associated with the main cable to shore.

### 9.2.2 Magnetic fields

A number of species are understood to use the earth's magnetic field to provide orientation during migrations. If the species perceive a different magnetic field to the earth's there is potential for them to react to local differences in the B field. Depending on the magnitude and persistence of the confounding magnetic field the impact could be a trivial temporary change in swimming direction, as seen with eels encountering a HVDC cable, or a more serious delay to the migration.

As with electric fields, we do not know the relative significance of the (relatively) narrow cable route compared to the network of cables within the array. It is likely that the B fields will be additive.

### 9.2.3 Cumulative Impacts

As the UK coastal zone becomes more developed there is a real need to consider offshore wind farms in the wider context of cumulative impacts. It will not be sufficient to consider a development on its own as the impact on the coastal electromagnetic environment may be added to be other offshore wind farm developments in the area or other developments adjacent to the site being considered.

In order to support cumulative assessments we need to understand the likely E and B fields generated by other offshore installations (cf. Section 7.3).

In terms of cumulative impact assessment the most pressing challenge is to improve our understanding of the actual significance of existing anthropogenic sources of E and B fields for receptor species. Until we can do this the assessment of cumulative impacts will only be possible by means of educated assumptions.

## 9.3 Assessment of Priority species

For all the UK coastal species that are electromagnetic-sensitive (see Tables 2 and 3) it is evident that our knowledge of their interaction with electromagnetic fields is limited. In Table 9 we have prioritised the species that are most likely to interact with offshore wind farm generated EMFs. Species chosen are benthic species and those with specific life history stages that utilise inshore waters.

The prioritisation was based on the review of existing knowledge (Sections 6 and 7), ecological importance, importance for other human activities (eg. fishing; recreation), the distribution and occurrence of the species within the areas of round 1 and 2

## COWRIE 1.5 Electromagnetic Fields

offshore wind farm developments, and the information gaps that exist within existing ESs and scoping studies for offshore wind farm developments. In addition, we took into consideration the existing conservation status of species at national and international levels. Although the conservation listings of threatened animals are valuable tools in creating a priority list it is important to note that they have several shortcomings in the context of EMFs. Fish species in general have not been evaluated for conservation status. Furthermore, many species (detailed in Tables 2 and 3), particularly the elasmobranchs, are not included in the listings but are suffering serious population declines. Hence, Table 9 will need to be updated as more information is obtained particularly relating to changes in UK conservation legislation.

**Table 9. Priority species for further investigation of significance of electromagnetic fields. Specific attributes that were used to include each species in the list are shown. All species are known to utilise near-shore waters at some stage of their life history.**

Species	E or B sensitive	Priority criteria
Angel shark ( <i>Squatina squatina</i> )	E B	Annex III Barcelona Convention; Annex III Bern Convention; biological and habitat vulnerability; Extirpated from some areas
Tope ( <i>Galeorhinus galeus</i> )	E B	UK BAP species; globally seriously depleted; vulnerable life stages
Spurdog ( <i>Squalus acanthias</i> )	E B	Endangered in NE Atlantic; biologically vulnerable
Thresher shark ( <i>Alopias vulpinus</i> )	E B	Severe population decline; vulnerable life stages
Porbeagle shark ( <i>Lamna nasus</i> )	E B	UK biodiversity priority list; vulnerable life stages
Common skate ( <i>Dipturus batis</i> )	E B	Endemic to NE Atlantic; biologically highly vulnerable; UK BAP species; IUCN Red List Endangered
White skate ( <i>Rostroraja alba</i> )	E B	Annex III Barcelona Convention; Annex III Bern Convention; biologically highly vulnerable
Long-nose skate ( <i>Dipturus oxyrinchus</i> )	E B	Biologically highly vulnerable; no conservation protection
Thornback ray ( <i>Raja clavata</i> )	E B	Severely depleted; heavy pressure from fishing; no conservation protection
European eel ( <i>Anguilla anguilla</i> )	E B	Severely depleted; biologically vulnerable; Annex II & IV EC Habitats Directive
Plaice ( <i>Pleuronectes platessa</i> )	E B	UK BAP; Fisheries species
European river lamprey ( <i>Lampetra fluviatilis</i> )	E B	Annex II & V EC Habitats Directive
Sea lamprey ( <i>Petromyzon marinus</i> )	E B	Annex II EC Habitats Directive
Atlantic salmon ( <i>Salmo salar</i> )	E B	Annex II & IV EC Habitats Directive
Cod ( <i>Gadus morhua</i> )	E	UK BAP; Fisheries species
Harbour porpoise ( <i>Phocoena phocoena</i> )	B	Annex II & IV EC Habitats Directive; ASCOBANS 1992; Appendix II Bern Convention; Appendix II CITES; Appendix II Bonn Convention; Schedule 5 WCA 1981; UK BAP species
Bottlenose dolphin ( <i>Tursiops truncatus</i> )	B	Annex II & IV EC Habitats Directive; ASCOBANS 1992; Appendix II Bonn Convention; UK BAP species
Loggerhead ( <i>Caretta caretta</i> )	B	CITES Appendix I; Appendix II Bern Convention; Appendices I & II Bonn Convention; Annex II & IV EC Habitats Directive; Schedule 5 WCA 1981
Leatherback ( <i>Dermochelys coriacea</i> )	B	CITES Appendix I; Appendix II Bern Convention; Appendices I & II Bonn Convention; Annex IV EC Habitats Directive; Schedule 5 WCA 1981
Decapod crustacea (lobster, crab, prawns)	B	Fisheries species



## 10 Priorities for further research

Owing to the lack of understanding of EMFs and their environmental impact the aim of this section of the report is to provide COWRIE with a specific set of research priorities and a statement of their benefits and limitations.

In order to do this we first defined a set of specific research questions, which we then prioritised using rationale based on the available information, the conservation status of UK EM sensitive species, the ecological importance of the species, any economic value (i.e. fisheries species), and the potential for obtaining definitive answers from the research within a timescale of a few years. We also considered the benefit to the wind farm industry of the research.

The phase 1 COWRIE study (CMACS 2003) highlighted that induced electrical fields generated by electromagnetic fields from industry standard cabling would potentially be detectable by electrosensitive fish species. The same study also demonstrated that cable burial did not provide full mitigation against such effects. There is still no conclusive evidence that either electromagnetic or induced electrical fields from submarine power cables associated with offshore wind farms have an impact on individual electrosensitive species or populations; however, the potential for impact is certainly present.

We believe that this uncertainty and potential environmental impact make the need for a fuller understanding of this subject area urgent. We envisage a two-stage approach:

1. A one-off mesocosm study involving the enclosure of a suitable area of seabed within which to study the response of a benthic EM sensitive test-species (e.g. an elasmobranch) to experimentally controlled B fields and induced electrical fields from a sub-sea cable.
2. Monitoring of electrically and magnetically sensitive species at individual wind farms, probably under FEPA conditions, as appropriate to site-specific conditions.

Within the first stage, study 1 aims to definitively determine if there is a response by an electromagnetic sensitive species to the EMF associated with a wind farm industry standard sub-sea electricity cable. We consider such a study to be the priority for the COWRIE Phase 2 study.

Monitoring (point 2 above) will be undertaken as part of the wind farm operators FEPA licence and will provide important data (which under FEPA conditions are to be public domain) from the actual wind farm sites. These data should be incorporated into the overall appraisal of electromagnetic and electric fields effects and ideally add to the COWRIE Phase 2 study. The monitoring programme for individual wind farms is dealt with in Section 11.

If the mesocosm study and/or the monitoring provide data to conclude that there are effects of EMFs on receptor species then stage 2 should be implemented. Stage 2 should address the following specific studies:

## COWRIE 1.5 Electromagnetic Fields

3. A collaborative study to monitor elasmobranch responses to submarine power cables at one or more UK offshore wind farm sites.
4. Collaborative study/studies to follow up potential impacts on magnetically sensitive species and/or non-elasmobranch electrically sensitive species at UK offshore wind farm sites.
5. Specific research to investigate electric and magnetic field significance for UK fish species in controlled environments and *in situ*.

Section 10.1 provides more detail on the likely scope of a COWRIE Stage 2 EMField study in particular and potential follow up work in general.

### **10.1 COWRIE Phase 2**

#### **10.1.1 Stage 1 Experimental mesocosm study**

As highlighted above, we recommend a one-off study involving the enclosure of a section of sub-sea cable within a suitable area of seabed to allow the response of an elasmobranch test species to experimentally controlled electrical fields to be assessed. This would provide the best opportunity to obtain sound scientifically based information on the primary question of interest: Do EM sensitive organisms respond to anthropogenic EMFs of the magnitude generated by offshore wind farms?

The study would be under controlled conditions but to improve its applicability to the actual situation the mesocosm experiment would take place in a shallow, sheltered coastal water location. The study should use ultrasonic telemetry technology, which will detect the real-time movements of individually identifiable fish in relation to an energised section of sub-sea electricity cable. This method is classed as passive as a set of telemetry receivers located within the mesocosm will automatically record the movements of the fish. The full record of each receiver can be downloaded remotely by a decoder at regular intervals.

It is expected that 40-50 adult elasmobranchs of the same species (eg. thornback ray) will need to be tagged externally and then released into one of two mesocosms. Half the fish will be released into a mesocosm with a cable running within it and the other half in a reference mesocosm (control).

Data on ambient environmental variables (e.g. temperature, state of tide, current, time of year), electric current in the cable and EMFs present throughout each mesocosm will be required to ensure that other potential influential factors are considered.

The advantage of this type of study is that it can be conducted in both good and poor conditions (eg. weather, turbidity) and the full movement of all fish within an enclosure would be recorded over a set period. The study should take place during the spring/summer period when temperatures are higher and elasmobranchs are more active. In addition, this is the time of year that many species move into shallower waters for reproductive activities; hence the fish are more likely to encounter any EMFs present as they will be searching for prey and mates.

A further advantage is that the data will be continuously recorded automatically reducing the amount of personnel time and effort.

The main disadvantage is that owing to the size of the study and the need to use an energised sub-sea cable system a significant investment of resources will be required. However, the investment would provide the evidence necessary to determine whether or not there are any effects of offshore wind farm cables on benthic elasmobranchs (the most likely receptor species to be affected).

### 10.1.2 Stage 1 *In situ* monitoring

COWRIE Phase 2 would therefore be primarily a biological study; however, it is important that the site-specific monitoring (cf. Section 11) is considered as part of the wider investigation of EMF effects and that this monitoring is supported by an appropriate level of knowledge about the spatial and temporal variability of EMFs at offshore wind farm sites. According to current understanding, wind farms will not produce a steady electromagnetic and induced electrical field over time owing to intermittency of winds. There will be periods during calm and very windy weather when no power will be generated and negligible electromagnetic fields are present. At North Hoyle, for example the minimum wind speed required is 4m/s and cut out occurs at speeds of 25m/s. The wind must then drop to 20m/s before power is again generated. However, even when no power is being generated, a small current will flow from the grid to the wind farm through the submarine cables to power auxiliary systems offshore. It is very important that the results of monitoring can be related to EMFs over the course of that monitoring. We therefore recommend that modelling of electromagnetic and induced electrical fields from outward base flow levels through to maximum generation conditions should be undertaken **for site-specific cabling arrangements** (where necessary) based on the approach adopted in the COWRIE Phase 1 EMF study (CMACS 2003). This would greatly assist in understanding changes in the electromagnetic field environment and to support biological monitoring provided records of power generation over the monitoring period were available to the monitoring team.

A major effort should continue the development of methods for directly measuring the electromagnetic fields such as the *in situ* probe developed through the COWRIE Phase 1 EMF study (CMACS 2003). A project of this nature can provide improvements in the quality of data collected at wind farm sites to further improve our understanding of the variability of EMF strength in relation to such environmental factors as wind, temperature and substratum type. Such data could then be used to develop probability scenarios for EMF emissions for a given set of environmental and engineering variables. The directly measured EMF data and these probabilistic scenarios could then be integrated with biological studies to provide comprehensive analysis of the interaction between OWFs and EM sensitive species, as detailed in section 10.1.3.

### **10.1.3 Stage 2 *in situ* and experimental studies**

Should the COWRIE Phase 2 stage 1 mesocosm study or monitoring at individual wind farm sites suggest that EMFs may indeed have effects there would be a need for the *in situ* significance of EM and iE fields for electrically and magnetically sensitive species at one or more UK offshore wind farm sites to be determined. Studies would aim to address the question of whether there is a consistent response within populations of EM sensitive species to the EMFs. Aspects such as spatial and temporal shifts in occurrence and changes in abundance relative to current understanding of the EMF would be addressed. The methods applied would depend to some extent on the resources available but tagging and tracking studies, using similar methods to those outlined for the mesocosm study, are recommended to assess spatial behaviour in real time. Such studies should be supplemented by data obtained from more traditional fisheries surveying which will be undertaken as part of the monitoring programme at a wind farm site. As with monitoring at individual wind farms, any project undertaken must quantify iE and B fields over the course of the study.

Further research will also be required to quantify habitat use by different life stages of EM sensitive species. A combination of field based surveys (as suggested above) and focused experimental study should aim to determine how and why species are attracted to or avoid particular wind farm locations or EMFs associated with wind farm specific cable configurations at any stage in the lifecycle or at specific times of the day/year. These data would be useful for future site location and cable laying routes and configuration and the timing of installation and operation. In addition, there is potential that there will be differential sensitivity with ontogenetic stage particularly in shallow nursery areas where the electric cables are likely to cross or be buried. Therefore studies of the most sensitive life stages would be important to link to the population based studies. These studies should also aim to consider the variability in response of different species to assist in the determination of species most affected (either positively or negatively) and try to determine if species can become habituated to the EMFs. Habituation studies will assist greatly in interpreting population level changes.

*Important note: experimental based studies may require UK Home Office licensing.*

## **11 Monitoring at wind farm sites**

### **11.1 Introduction**

Environmental monitoring requirements for consented offshore wind farms are determined by FEPA (Food and Environment Protection Act 1985) licence conditions. The FEPA licence generally states the broad principals of monitoring but leaves the details of that monitoring open for discussions between the developer (and their scientific consultants) and statutory bodies (English Nature; Countryside Council for Wales and CEFAS). The following, for example, is an extract from the FEPA licence for Barrow Offshore Wind Farm (FEPA Licence number 31744/03/3), equivalent paragraphs can be found in the FEPA licences for most of the consented offshore wind farms (Appendix 12 FEPA licences):

The Licence Holder must provide the Licensing Authority with information on attenuation of field strengths associated with the cables, shielding and burial described in the Method Statement and related to data from the Rødsand wind farm studies in Denmark and any outputs from the COWRIE tendered studies in the UK. This is to provide reassurance that the cable shielding and burial depth(s), both between the turbines and along the cable route to shore, given the sediment type(s) at the Barrow site are sufficient to ensure that the electromagnetic field generated is negligible. Should this study show that the field strengths associated with the cables are sufficient to have potential detrimental effect on electrosensitive species, further biological monitoring to that described in Section 7 of this Annex may be required to further investigate the effect.

Although it is now established, following the phase 1 COWRIE study (CMACS 2003) that cable burial does not provide sufficient mitigation for electromagnetic field effects, it is still not clear whether either magnetic or induced electrical fields from industry standard submarine cables have significant impacts on potentially sensitive species. Our suggested approach to further collaborative research is outlined in Section 10.1.

In this section we consider monitoring that would be appropriate to individual wind farms. We have endeavoured to suggest monitoring that would be suitable both for consented wind farms, should further monitoring be invoked, and for planned wind farms should it be decided that future FEPA licence conditions will specify such monitoring outright.

It is worth noting that existing monitoring has focused on electrically sensitive species and elasmobranchs in particular. We have considered magnetically sensitive species in Section 11.3.3 and provide guidance on suitable monitoring in Section 11.4.

### **11.2 Existing Monitoring**

Of the currently consented and/or constructed wind farms we obtained information about monitoring relevant to the investigation of electromagnetic and electrical field effects for 3 wind farms: North Hoyle, Robin Rigg and Lynn & Inner Dowsing (the latter considered under a single monitoring programme). All monitoring programmes

## COWRIE 1.5 Electromagnetic Fields

are geared towards electrosensitive species, even though the programmes are usually termed 'EMF monitoring'.

**North Hoyle** Limited data on fish populations are available from annual surveys using 2m scientific beam trawls. These trawls generally target benthic invertebrates but some elasmobranchs (various ray species) are typically caught. The main fish/fisheries monitoring makes use of data from routine CEFAS fisheries and consultations with local commercial fishermen. The CEFAS surveys use a 4m-beam trawls with a chain mat, flip up rope, and 40mm cod end liner to retain small fish. They cover the western seaboard of England and Wales and have taken place every autumn since 1988. Since 1993, a grid of 34 stations has been consistently fished in the eastern Irish Sea with one station in the vicinity of North Hoyle (approximately 2 km east). The most recently available monitoring report (2003-2004) covers the construction period; no information is yet available on monitoring of the operation period.

**Robin Rigg** Construction of this development is anticipated for 2006. The following is an extract from the monitoring plan for electroreceptive fish species submitted to the Scottish Executive:

### **Pre-construction**

*Reasons:* To gain an understanding of the abundance and distribution of electroreceptive fish in the vicinity of the cable route to shore prior to power being carried on the cable.

*Suggested survey type:* It is suggested that surveys cover all electrosensitive fish species but it acknowledged that the Thornback ray is the more commercially important of the electroreceptive fish in the Solway. The most appropriate survey would be a survey using a beam trawl along the cable route.

*Timing and Frequency:* Indicative frequency of quarterly for 1 year prior to the cable being energised. Timing may need to be seasonally adjusted to match behaviour of relevant species.

Note that these surveys can be carried out during the construction period provided the cable has not been energised and that there is no nearby impact piling activity at the time of the surveys.

### **During construction**

None considered necessary as a single season pre-commissioning of the wind farm should be sufficient.

Note that "pre-construction" surveys can be carried out during the construction provided the cable has not been energised and that there is no nearby impact piling activity at the time of the surveys.

### **Post-construction**

*Reasons:* To allow any changes in abundance/distribution of electroreceptive fish following powering of the cable.

*Suggested survey type:* As with pre-construction. Potential impact of changes in benthic food supply due to cable installation to be considered in detailed methodology.

## COWRIE 1.5 Electromagnetic Fields

*Timing and Frequency:* Timing may need to be seasonally adjusted to match behaviour of relevant species. Indicative frequency of quarterly for 1 year following the wind farm being fully operational, assuming benthic community has recovered.”

**Lynn & Inner Dowsing** A baseline fish survey has been agreed, the results of which will inform future monitoring. Details provided by the developer are as follows:

The aim of the fishing study is to gather baseline information on local fish communities against which data collected following construction of the Lynn and Inner Dowsing wind farms can be compared. Data will be collected using scientific methods to assess species diversity, numbers present and community structure. Data will also be collected using commercial methods to capture data for commercially viable species.

An outline fishing programme has been developed in consultation with local fishermen and fishing organisations. The programme will involve surveys using both standard scientific methods (2m beam trawl with a 4mm mesh size cod-end) and more traditional commercial fishing methods; otter trawls, shrimp trawls, mussel dredges, long-lines and pots. Scientific fishing will provide data on species diversity and community structure in a quantitative and repeatable manner, whilst the commercial fishing methods will provide data on specific commercially viable species and groups of species, present before and after construction of the wind farms. Commercial target groups include crab, lobster, cod, sole, roker, whiting, brill, brown and pink shrimps and mussels.

Commercial surveys will be carried out in a scientific manner; i.e. the same effort will be applied to all surveys within the Study Area, for each commercial gear-type used. Repeat surveys within-years and between-years can be carried out in the same locations used during the initial baseline surveys and indicative ‘catch per unit effort’ (CPUE) will be calculated wherever sufficient numbers of individual for a species are caught. Although CPUE of quarterly surveys will have little value in determining population size, it is likely to give an indication of relative changes in population size/use of an area by a species over time.

The following programme has been agreed:

### **Scientific beam trawling (standard 2m scientific beam):**

- 4 quarterly surveys over a 1-year period
- 11 sampling stations across the Lynn and inner Dowsing wind farms; 2 within each wind farm, 2 within the cable route and a number of controls.
- 3 replicate surveys undertake at each of the 11 sampling stations
- All fish measured and electro sensitive species sexed

### **Commercial otter trawls (15m wide):**

- 4 quarterly surveys over a 1-year period
- 11 sampling stations across the Lynn and inner Dowsing wind farms (using the same sampling stations as used for the scientific beam trawling); 2 within each wind farm, 2 within the cable route and a number of controls.
- A single 30-minute tow undertaken at each of the 11 sampling stations
- All fish measured and electro sensitive species sexed

**Commercial Potting (standard pots):**

- 6 surveys undertaken over a 1-year period with frequency/timing of surveys developed in consultation with local fishermen to include periods when the fishermen would be out after target species.
- Each of the 6 surveys comprises a 5 day period; pots are laid on the first day, left to soak for 3 days and retrieved on the 5 day.
- A biologist accompanies the fishermen on the 5<sup>th</sup> day to ID catch, measure carapace length and sex individuals.
- Ten sampling stations will be surveyed for crab and lobster. Each sampling station will be sampled by one string of 20 pots totalling 200 pots across the Study Area.
- The pots are baited with scad (*Trachurus trachurus*)

**Commercial Shrimp surveys:**

- 12 locations will be surveyed over a 2-day period on 6 occasions over 1-year. This includes sampling stations within each wind farm, the cable route and controls.
- Two (2) 10m commercial beam trawls will be deployed and towed with the current for a period of 10 minutes bottom time;
- The two 10m beam trawls will be towed at a distance of approximately 10–15m apart;
- A biologist will accompany the fishing vessel to identify and enumerate the shrimp caught;
- An average will be calculated for the two pseudo-replicates;
- Biometric data will be collected for a representative number of shrimp in each catch
- (commercial size classes for shrimp A, B, C or D)
- A species list for the by-catch will be compiled (and all electro sensitive species are ID, measured and sexed)

**Commercial Long Line Surveys:**

- 11 locations will be surveyed over a 2-day period on six occasions between October 2004 and March 2005 at a frequency of one survey per month. Sampling stations are located within the wind farms, cable route and a number of controls.
- 100 hooks will be deployed per fishing line;
- Lines will be worked on the tide during daylight
- The location of the in-shore end of the line will be recorded
- The fisherman will record the numbers of each species caught per line

**Commercial Mussel Dredging surveys:**

Anticipated that there will be 6 surveys of 2-days per survey across 10 to 12 sampling locations.

The above existing (North Hoyle) or planned (Robin Rigg/Lynn & Inner Dowsing) monitoring programmes all seek to monitor species of interest in an objective, scientific manner. The Lynn & Inner Dowsing programme is especially



comprehensive and will make heavy use of local commercial fishing vessels capabilities to provide monitoring for the wind farm.

All the programmes rely to a lesser or greater extent on beam trawls. Potential advantages and disadvantages of this method are considered further in Section 11.3 below.

None of the programmes specifically considers magnetically sensitive species and there is a heavy bias towards elasmobranchs, and particularly rays, in terms of electrically sensitive species. The bias towards elasmobranchs is understandable and to a degree justified given the commercial and conservation importance of many species in this group. There are other groups and species which ought to be considered and which could usefully be studied relatively easily, including plaice, dogfish and crustaceans (shrimp, prawn, crab and lobster). Suitable survey methods are considered in the following sections.

### ***11.3 Potential survey methods for electrically and magnetically sensitive species***

In the following section we seek to provide an overview of the potential survey methods for a range of electrically and magnetically sensitive species, prior to offering broad guidance on monitoring surveys in Section 11.4.

We have focused the review on electrically and magnetically sensitive species that are likely to be of most interest for monitoring and offer the best opportunity to obtain conclusive results, i.e. species occurring in reasonable numbers in areas of wind farm development. From the electrically sensitive species we have selected elasmobranchs, in particular dogfish and thornback ray, and European eel (all species also magnetically sensitive). From magnetically sensitive species we have considered suitable methods for salmonids, plaice and Crustacea (salmonids and plaice also potentially electrically sensitive).

Survey methods for less common (but potentially important species) such as turtles, basking shark etc. are reviewed briefly in Table 6 which also provide a summary of all methods considered.

#### **11.3.1 Electrically Sensitive Species**

Skates, rays and sharks are not commercially targeted fish, with the exception of a tangle-net fishery in the south-east of England, but are an important by catch of beam trawls, otter trawls and long-lines. As a result, dedicated fishing equipment for catching elasmobranchs has not been developed and there are various pros and cons to potential sampling methods as detailed below.

Skates, rays and sharks are relatively resilient to the fishing technique used to capture them and can survive being hauled from the seabed and landed on a boat as long as they are released within a few minutes.

## COWRIE 1.5 Electromagnetic Fields

Populations of large (commercially sized) rays can be monitored by examining landings at port and enquiring with fishermen where the rays were caught and how many were released at sea. Such an approach will not provide detailed site specific data but may provide useful supporting information to other surveys. A major drawback, however, is that commercial fishing is very much restricted within offshore wind farm arrays.

Standard scientific (2m) beam trawls will effectively target juvenile skates, rays and dogfish but will not sample larger individuals with any efficiency as many are able to evade capture. A 4m beam trawl would be more appropriate where mature skates and rays are the species of interest.

At some sites a GOV trawl (Grande Overture Verticale- a high-headline demersal trawl with 16 to 18 m wide opening) may be an appropriate monitoring technique in place of beam trawling. This is used by CEFAS for routine ground fish surveys (e.g. Irish Sea) and will catch adult skates and rays in addition to a limited ability to catch pelagic species present near the sea bed at the time of survey (e.g. mackerel); however, it does have similar drawbacks to standard scientific and commercial beam trawls (cf. Table 6). The GOV specification is defined by ICES and is used in surveys in the west of Scotland and the eastern English Channel, and has recently been adopted as the main trawl for surveys in the Irish Sea and Celtic Sea. A clear disadvantage is the extra size and consequent lack of manoeuvrability in and around wind farms and increased damage to seabed habitats. However, such an approach may be suitable for monitoring along cable routes to shore if adult skates and rays are of interest.

Other electrically sensitive species (eels, salmonids and plaice) that may be present round offshore wind farm sites may require different survey methods. Whilst 2 or 4m beam trawls may be appropriate for plaice, salmonids and eels present a different proposition. In general, it is difficult to envisage how migratory species that only pass through a wind farm area or across a cable route could be monitored effectively in offshore environments. There may be opportunities where power cables to shore cross known migratory routes close inshore to set up fish traps for salmonids or eels (cf. Hvidt *et al.* 2003); however, opportunities for this type of study in the UK are very limited and Robin Rigg and Teeside offshore wind farms are probably the only UK sites where such a study could be envisaged.

A number of other potential monitoring techniques exist, some of which have advantages over beam trawls in particular as they are non-destructive. These are considered in Table 6, below; however, it is worth commenting on non-destructive techniques in more detail.

Towed video, diver and baited video surveys all potentially offer opportunity to survey populations of target species with no (or in the case of towed video very limited) damage to either seabed habitat or target species.

There is a fundamental drawback to towed video surveys in that the limited width of the survey transects coupled with the poor (to negligible) visibility that can be expected at many coastal sites mean that very high survey effort would be required to obtain significant data. It would be unlikely that species could be identified with any confidence and individuals certainly could not be sexed. Towed video may be

able to discriminate if submarine power cables have a significant aggregating effect on target species, but are otherwise unlikely to be of practical use.

Diver surveys suffer similar drawbacks to towed video surveys in that intensive effort would be required to obtain sufficient data. There is also the additional complication of working around limited tidal windows at most sites. Again, diver surveys would only be able to detect gross aggregating effects of cables or, perhaps, responses of individual animals to E fields.

Baited video is a proven technique in certain habitats, notably reefs and other areas of high visibility. It is less commonly applied in shallow UK coastal sites where wind farms are built. We are not aware of the efficacy of this technique for species such as rays, dogfish, crabs and plaice; however, provided appropriate bait is selected it may be successful. It would be very important to establish suitable controls away from cables since it is unclear whether the presence of bait (and olfactory cues) may override E field effects. It may be worthwhile investigating baited video in situations where beam trawling is not possible.

### **11.3.2 Magnetically Sensitive Species**

Methods for salmonids and plaice have already been considered in Section 11.3.1. Crustacea, in particular lobster, crab, shrimp and prawn, may be of interest at certain wind farm sites. Shrimp and prawn may be sampled by beam trawling methods already mentioned. Crab and lobster<sup>3</sup> may readily be surveyed by pot sampling; however, there are similar drawbacks to the baited video approach discussed above in that it may be difficult to differentiate B field effects from olfactory cues resulting from bait in the pots.

Pots are also likely to sample dogfish which should be counted, measured and sexed if present.

Shrimp and prawn will also be captured in pots; however, crab and lobster will predate on them within pots and it may therefore be difficult to generate reliable data on these groups.

---

<sup>3</sup> although lobster are unlikely to be important species prior to wind farm construction (due to the non-rocky nature of seabed habitat) they may become important once monopiles and associated scour protection is present.

**Table 6. Advantages and disadvantages of various sampling methods for electrically and magnetically sensitive species.**

<b>Method</b>	<b>Advantages</b>	<b>Disadvantages</b>
<b>Generic Methods</b>		
Beam trawl	Animals can be released alive. Low effort. Individuals of all sizes caught. Semi-quantitative Mesh size can be adjusted to suit target species	Dedicated vessel required. Unsuitable on rocky ground/ near underwater obstacles. Does not target rays which can easily evade Slower trawls (especially smaller 2 m scientific trawl). Damages seabed. High bycatch. Low and fixed headline height.
GOV Trawl	As beam trawl Plus samples some demersal species and large size leads to higher catches	As beam trawl Plus large size means more seabed damage and less manoeuvrable around wind farm arrays
Otter Trawl	Animals can be released alive. Low effort. Individuals of all sizes caught. Semi-quantitative Variable headline height Mesh size can be adjusted to suit target species	Dedicated vessel required. Unsuitable on rocky ground/ near underwater obstacles. Damages seabed. High bycatch.
Gill & Tangle nets	Can be deployed anywhere in a tidal stream. Low effort. Semi-quantitative	High bycatch. Animals usually brought up dead. Only samples larger individuals. Gill nets target specific size and age classes
Long-lining	Can be deployed anywhere and rigged to catch benthic/demersal fish. Low effort. Does not damage seabed. May be semi-quantitative.	Animals often brought up dead. Samples large individuals only.
Angling	Animals generally released alive. Low bycatch. Can be rigged to target sharks and rays. Does not damage seabed.	Only samples large individuals (typically). High effort. Likely to be only qualitative Animals could be damaged.
Baited Video	No damage to animals or seabed.	Unknown efficacy for interest species. Not clear how quantitative this method would be. Design needs to ensure the presence of bait does not mask B/E field effects.
Tagging	High spatial resolution of fish movements and (potentially) directional response to cables. Quantitative data obtained. Target species can be assessed.	Animals must be caught first by angling or trawling. Very high effort and expensive. Only possible to tag large individuals.
Traps and Pots	Likely to be effective for dogfish and Crustacea (crabs and lobster) if standard baited lobster pots are used. Accurate positioning of pots in relation to cables is possible. Animals can be returned alive	Not effective for skates, rays or other species of interest (e.g. plaice, salmonids). Presence of bait would possibly mask electric field effects.

## COWRIE 1.5 Electromagnetic Fields

Method	Advantages	Disadvantages
<b>Other Specialist Surveys</b>		
<b>Cetacea</b>		
Boat surveys	Can cover a large area None intrusive	Time consuming Spatially and temporally limited information
Spotter plane	Can cover a large area None intrusive	Expensive Temporally limited information
Photo surveys	Identify individuals Give population level information Spatial information over time	Highly time consuming Needs several years of data to provide useful data on population distribution Impractical with low density populations and unlikely to provide sufficient site-specific data to assess a wind farm site.
		Disadvantage with all cetacean surveys is that observations will be made at the surface when animals are not close to cables. Only gross assessments possible, e.g. avoidance of an area of increased numbers in an area-very difficult to relate to B/E field effects.
<b>Chelonia</b>		
Tagging	Animals can be released alive. Low effort. Individuals of all sizes caught. Semi-quantitative	Dedicated vessel required. Low numbers (UK)
Tagging	High spatial resolution of fish movements and (potentially) directional response to cables. Quantitative data obtained. Target species can be assessed.	Animals must be caught first by angling or trawling. Very high effort and expensive. Only possible to tag large individuals.

### 11.4 Guidelines for Monitoring

The choice of survey method(s) depends heavily on the objective of the study, the site, the nature of the seabed and target species. The proposed monitoring for Lynn & Inner Dowsing provides a very good example of the range of surveys that may be required to cover fish/fisheries assemblages of interest; however, it may be appropriate for specific target groups or species to be monitored at other wind farms. We offer the following guidance for studies which seek to monitor fish at offshore wind farm sites in relation to E and B fields:

- The methods most likely to be applicable to UK offshore wind farms are 4 m beam trawls (adult demersal electrosensitive species such as thornback ray and dogfish and plaice), 2 or 4m beam trawls (juvenile rays, shrimp and prawns) and pot surveys (crab and lobster).
- The above methods, in particular beam trawls, should complement routine epibenthic biological monitoring at most wind farms but sample locations will need to be carefully considered in relation to cabling infrastructure (see below).
- At individual wind farms there may be a need to consider other methods if there are different species of interest, such as salmonids or eels.
- Studies should adopt a BACI (Before, After, Control and Impact) approach. For wind farms this means a baseline survey of control (reference) and impact sites

## COWRIE 1.5 Electromagnetic Fields

and repeat monitoring of the same sites during the operational phase. This would not be possible for existing wind farms should monitoring begin after construction; in this case comparison of impact and control sites is the only approach available.

- Control sites should be carefully located so that they represent comparable habitat to impact sites and are not subject to interference from other electric fields (e.g. other power or telecommunication cables). If such sources are in the vicinity of the wind farm their EMF effects should be researched and understood.
- Impact sites should be precisely located so that, for example, trawls along cable routes follow the cable as closely as possible (or cross several buried cables within an array), or live traps are placed within known distances of the cable. This will require use of DGPS equipment and good information on installed position of cables. The Geocable GIS database should be used to obtain the required information for non-wind farm infrastructure; it is assumed that developers will be fully aware of the exact location of cables relating to their wind farm.
- During studies data should be gathered on power generating activity of the wind farm and related to modelled or measured B and E fields. Information on the spatial and temporal variability of E and B fields then needs to be carefully related to biological data from monitoring.
- Where possible individual animals captured during survey should be both measured and sexed. This should be simple for elasmobranchs and will assist in the identification of any age/sex related difference in behaviour in relation to E and B fields.

## 12 Acknowledgements

Gero Vella; Carolyn Heeps; Cathryn Hooper; members of COWRIE; all the offshore wind farm developers who responded to the consultation; Cranfield University Library staff; KISCA Charts: Submarine Cable Location and Route Information; Brian Perratt and Global Marine Systems.

## 13 References

Adair R.K., Astumian R.D. & Weaver J.C. (1998) Detection of weak electric fields by sharks, rays, and skates, *Chaos*, **8** (3): 576-587.

Barber, N. & Longuet-Higgins, M.S. (1948) Water movements and earth currents: electrical and magnetic effects. *Nature*, **161**: 192-193.

Bochert, R. & Zettler, M.L. (2004) Long-term exposure of several marine benthic animals to static magnetic fields. *Bioelectromagnetics* **25**: 498-502.

Bodznick, D. & Boord, R.L. (1986) Electroreception in Chondrichthyes: central anatomy and physiology, In *Electroreception*, (ed. T.H. Bullock & W. Heiligenberg): 225-256, John Wiley and Sons, New York.

Boord, R.L. & Campbell, C.B.G. (1997) Structural and functional organisation of the lateral line system of sharks. *American Zoologist*, **17**: 431-441.

Bio/consult as (2002) Possible effects of the offshore wind farm at Vindeby on the outcome of fishing. SEAS Vindeby. Electromagnetic Fields and Noise. Document No. 1920-003-001-rev.2.

Brown, H.R., Andrianov, G.N. & Ilyinsky, O.B. (1974) Magnetic field perception by electroreceptors in Black Sea skates, *Nature*, **249**: 178-179.

Cameron, I.L., Hunter, K.E. & Winters, W.D. (1985) Retardation of embryogenesis by extremely low frequency 60 Hz electromagnetic fields, *Physiological chemistry and physics and medical NMR*, **17**: 135-138.

Cameron, I.L., Hardman, W.E., Winters, W.D., Zimmerman, S. & Zimmerman, A.M. (1993) Environmental magnetic fields: influences on early embryogenesis, *Journal of Cell Biochemistry*, **51**: 417-425.

CMACS (2003) *A baseline assessment of electromagnetic fields generated by offshore wind farm cables*. Rep. No. COWRIE EMF-01-2002 66. Centre for Marine & Coastal Studies.

Gill, A. B. (2005) Offshore renewable energy - ecological implications of generating electricity in the coastal zone, *Journal of Applied Ecology*, **42**: 605-615

## COWRIE 1.5 Electromagnetic Fields

Gill, A.B. & Taylor, H. (2001) The potential effects of electromagnetic fields generated by cabling between offshore wind turbines upon elasmobranch fishes, Countryside Council for Wales, Contract Science Report 488.

Hvidt CB, Bech M & Klaustrup M (2003) Monitoring Programme- status Report 2003. Fish at the cable trace. Nysetd offshore wind farm at Rodsand.

ICES (2003) <http://www.ices.dk/products/CMdocs/2003/E/E0903.PDF>

Kajiura, S.M. (2003) Electroreception in neonatal bonnethead sharks, *Sphyrna tiburo*, *Marine Biology*, **143** (3): 603-611.

Kalmijn, A.J. (1971) The electric sense of sharks and rays, *Journal of Experimental Biology*, **55** (2): 371-383.

Kirschvink, J.L. (1997) Magnetoreception: homing in on vertebrates, *Nature*, **390**: 339-340.

Leya, T., Rother, A., Müller, T., Fuhr, G., Gropius, M. & Watermann, B. (1999) Electromagnetic antifouling shield (EMAS) – a promising novel antifouling technique for optical systems, *10<sup>th</sup> International Congress on Marine Corrosion and Fouling*, University of Melbourne, February 1999.

Marra, L.J. (1989) Sharkbite on the SL submarine lightwave cable system: history, causes and resolution, *IEEE Journal of Oceanic Engineering*, **14** (3): 230-237.

Metcalf, J.D., Holford, B.H. & Arnold, G.P. (1993) Orientation of plaice (*Pleuronectes platessa*) in the open sea - evidence for the use of external directional clues, *Marine Biology*, **117** (4): 559-566.

Meyer, C.G., Holland, K.N. & Papastamatiou, Y.P. (2004) Sharks can detect changes in the geomagnetic field, *Journal of the Royal Society Interface*, (DOI: 10.1098/rsif.2004.0021 FirstCite): 2pp.

Murray, R.W. (1974) The ampullae of Lorenzini, In *Electroreceptors and other specialized organs in lower vertebrates*, (ed. A. Fessard): 125-146, Springer-Verlag, New York.

New, J.G. & Tricas, T.C. (1998) Electroreceptors and magnetoreceptors: morphology and function. In: *Cell Physiology Source Book* (ed. N. Sperlakis) 2<sup>nd</sup> ed.: 741-758, Academic Press, San Diego.

Pals, N., Valentijn, P. & Verwey, D. (1982) Orientation reactions of the dogfish, *Scyliorhinus canicula*, to local electric fields, *Netherlands Journal of Zoology*, **32** (4): 495-512.

Paulin, M.G. (1995) Electroreception and the compass sense of sharks, *Journal of Theoretical Biology*, **174** (3): 325-339.

Poddubny, A.G. (1967) Sonic tags and floats as a means of studying fish response to natural environmental changes to fishing gears, In *Conference on fish behaviour in relation to fishing techniques and tactics*, Bergen, Norway: 793-802, FAO, Rome.



## COWRIE 1.5 Electromagnetic Fields

Raschi, W. (1978) Notes on the gross functional morphology of the ampullary system in two similar species of skates, *Raja erinacea* and *R. ocellata*, *Copeia*, **1**: 48-53.

Raschi, W. (1986) A morphological analysis of the ampullae of Lorenzini in selected skates (Pisces, Rajoidei), *Journal of Morphology*, **189** (3): 225-247.

Tricas, T.C. (2001) The neuroecology of the elasmobranch electrosensory world: Why peripheral morphology shapes behavior, *Environmental Biology of Fishes*, **60** (1-3): 77-92.

Ugolini, A. & Pezzani, A. (1995) Magnetic compass and learning of the Y-axis (sea-land) direction in the marine isopod *Idotea baltica basteri*. *Animal Behaviour*, **50**: 295-300.

Ugolini, A. (1993) Solar and magnetic compass in equatorial sandhoppers: equinoctial experiments. In: *Orientation and Navigation. Birds, Humans and Other Animals*. Oxford: The Royal Institute of navigation.

Ugolini, A. & Macchi, T. (1988). Learned component in the solar orientation of *Talitrus saltator* Montagu (Amphipoda, Talitridae). *Journal of Experimental Marine Biology and Ecology*, **121**: 79-87.

von der Emde, G. (1998) Electoreception, In *The Physiology of Fishes*, (ed. D.H. Evans): 313-343, CRC press.

Walker, T.I. (2001) Basslink project review of impacts of high voltage direct current sea cables and electrodes on Chondrichthyan fauna and other marine life, *Basslink Supporting Study No. 29, Marine and Freshwater Resources Institute*, **No. 20**: 68pp.

Westerberg, H. (2000) Effect of HVDC cables on eel orientation, In *Technische Eingriffe in Marine Lebensraume* (ed. T. Merck & H. von Nordheim),: 70-76, Bundesamt fur Naturschutz.

Willows, A.O.D. (1999) Shoreward orientation involving geomagnetic cues in the nudibranch mollusc *Tritonia diomedea*. *Marine and Freshwater Behavioural Physiology*, **32**: 181-192.

Zakon, H.H. (1986) The electroreceptive periphery, In *Electroreception*, (ed. T.H. Bullock & W. Heiligenberg): 103-156, John Wiley and Sons, New York.

Zimmermann, S., Zimmermann, A.M., Winters, W.D. & Cameron, I.L. (1990) Influence of 60-Hz magnetic fields on sea urchin development, *Bioelectromagnetics*, **11**: 37-45.

## 14 Appendices

Appendix 1 – 6 Bibliography collated by subject category:

- 1a) Offshore wind farms - general
- 1b) Offshore wind farms - specific
- 1c) Other e-sources - general
- 1d) Other e-sources - specific
- 2a) Chondrichthyans - electroreception - general
- 2b) Chondrichthyans - electroreception - physiology
- 2c) Chondrichthyans - electroreception – behaviour
- 3a) Chondrichthyans - magnetoreception - general
- 3b) Chondrichthyans - magnetoreception - physiology
- 3c) Chondrichthyans - magnetoreception - behaviour
- 4a) Other organisms - electroreception - general
- 4b) Other organisms - electroreception - physiology
- 4c) Other organisms - electroreception - behaviour
- 5a) Other organisms - magnetoreception - general
- 5b) Other organisms - magnetoreception - physiology
- 5c) Other organisms - magnetoreception - behaviour
- 6) Natural e-field sources

Appendix 7 Consultation Request sent to Offshore Wind Farm Developers

Appendix 8. KIS-CA cable awareness charts.

Appendix 9. CEFAS Fisheries data for ray species

Appendix 10. Report by EConnect Ltd.

Appendix 11. Questions and responses regarding the report COWRIE-EMF-01-2002  
“A Baseline study of electromagnetic fields generated by offshore  
windfarm cables.

Appendix 12 FEPA licence conditions for UK offshore wind farms relating to fish and  
electromagnetic/electrical fields

## COWRIE 1.5 Electromagnetic Fields

### Appendix 1a) Offshore wind farms - general

Centre for Marine and Coastal Studies (CMACS) (2003) A baseline assessment of electromagnetic fields generated by offshore wind farm cables, COWRIE-EMF-01-2002: 71pp.

Doyle, F. (2000) The implications of offshore renewable energy to fisheries around the Irish Sea, *Seminar on Offshore Renewable Energy*, Irish Sea Forum, No. 23.

Ecoserve (2000) Assessment of impact of offshore wind energy structures on the marine environment, Volumes I & II, The Marine Institute, Ireland.

Engell-Sorensen, K. (2002) Possible effects of the offshore wind farm at Vindeby on the outcome of fishing: the possible effects of electromagnetic fields and noise, Bio/consult as report prepared for SEAS, Doc. No. 1920-003-001-rev.2: 23pp.

ETSU (2000) An assessment of the environmental effects of offshore wind farms, Department of Trade and Industry, W/35/00543/REP.

Farrier, D. (1997) Wind energy in the coastal environment - prospects for a nearshore wind farm off East Anglia, In *Marine environmental management review of 1996 and future trends* (ed. R.C. Earll): 85-88, Kempley, Gloucestershire, UK.

Gill, A. B. (in press) Offshore renewable energy - ecological implications of generating electricity in the coastal zone, *Journal of Applied Ecology*.

Innogy Plc. (2002) North Hoyle Environmental Impact Statement, NWP Offshore Energy.

RSK Environment Ltd (2002) Barrow Offshore Wind Farm Environmental Impact Statement, Warwick Energy.

Russell, A. (2002) Appraisal of the impact assessment procedure for offshore wind farm development and the potential role of GIS as a strategic planning tool, Unpublished thesis, University of Liverpool.

US Army Corps of Engineers (2004) Electrical and magnetic fields, *Cape Wind Energy Project Draft Environmental Impact Statement: 5-238 to 5-250*, Cape Wind Associates, New England District.

Warneke, R.M. (2001) Marine Mammals in Bass Strait, with reference to the Basslink Project, Prepared for NSR Environmental Consultants Pty Ltd: 32pp., Warneke Marine Mammal Services, Tasmania, Australia.

**Appendix 1b) Offshore wind farms - specific**

Dolman, S.J., Simmonds, M.P. & Keith, S. (2003) Marine wind farms and cetaceans, *A WDCS Science Report*, Whale and Dolphin Conservation Society.

Gill, A.B. & Taylor, H. (2001) The potential effects of electromagnetic fields generated by cabling between offshore wind turbines upon elasmobranch fishes, Countryside Council for Wales, Contract Science Report 488.

Hoffman, E., Astrup, J., Larsen, F., Munch-Petersen, S. & Strottrup, J. (2000) Effects of marine wind farms on the distribution of fish, shellfish and marine mammals in the Horns Rev area, Danish Institute for Fisheries Research: 42pp.

**Appendix 1c) Other e-sources - general**

Andrulewicz, E., Napierska, D. & Otremba, Z. (2003) The Environmental effects of the installation and functioning of the submarine *SwePol* HVDC transmission line: a case study of the Polish Marine Area of the Baltic Sea, *Journal of Sea Research*, **49**: 337-345.

Coffen-Smout, S. & Herbert, G.J. (2000) Submarine cables: a challenge for ocean management, *Marine Policy*, **24**: 441-448.

International Commission on Non-ionizing Radiation Protection (ICNIRP) (2000) Effects of electromagnetic fields on the living environment, In *Proceedings of the International Seminar on Effects of Electromagnetic Fields on the Living Environment*, Ismaning, Germany, (ed. R. Matthes, J.H. Bernhardt & M.H. Repacholi).

Poleo, A.B.S., Johannessen, H.F. & Harboe Jr, M. (2001) High voltage direct current (HVDC) sea cables and sea electrodes: effects on marine life. First revision of the literature study: 42pp., Institute of Biology, University of Oslo, Norway.

Volpe National Transportation Systems Centre (VNTSC) (1994) Northeast corridor improvement project electrification - New Haven, CT to Boston, MA: final environmental impact statement/report, US Dept of Transportation, Federal Railroad Administration, Office of Railroad Development (Washington, DC): 478pp., National Technical Information Service, Springfield, VA.

**Appendix 1d) Other e-sources - specific**

Mackenzie, D. (1986) Shark bites halt trans-Atlantic cable, *New Scientist*, **111** (1517): 18.

Marra, L.J. (1989) Sharkbite on the SL submarine lightwave cable system: history, causes and resolution, *IEEE Journal of Oceanic Engineering*, **14** (3): 230-237.

Walker, T.I. (2001) Basslink project review of impacts of high voltage direct current sea cables and electrodes on Chondrichthyan fauna and other marine life, *Basslink Supporting Study No. 29, Marine and Freshwater Resources Institute*, **No. 20**: 68pp.

Westerberg, H. (2000) Effect of HVDC cables on eel orientation, In *Technische Eingriffe in Marine Lebensraume* (ed. T. Merck & H. von Nordheim): 70-76, Bundesamt für Naturschutz.

**Appendix 2a) Chondrichthyans - electroreception - general**

Adair R.K., Astumian R.D. & Weaver J.C. (1998) Detection of weak electric fields by sharks, rays, and skates, *Chaos*, **8** (3): 576-587.

Bleckmann, H. & Hofmann, M.H. (1999) Special senses, In *Sharks, skates and rays: the biology of elasmobranch fishes* (ed. W.C. Hamlet): 300-328, John Hopkins University Press, Baltimore.

Collin, S.P. & Whitehead, D. (2004) The functional roles of passive electroreception in non electric fishes, *Animal Biology*, **54** (1): 1-25.

Dijkgraaf, S. (1964) Electroreception and the ampullae of Lorenzini in elasmobranchs, *Nature*, **1**: 201-523.

Fields, R.D., Bullock, T.H. & Lange, G.D. (1993) Ampullary sense-organs, peripheral, central and behavioural electroreception in chimeras (*Hydrolagus*, Holocephali, Chondrichthyes), *Brain Behaviour and Evolution*, **41** (6): 269-289.

Fields, R.D. & Lange, G.D. (1980) Electroreception in ratfish (*Hydrolagus colliciei*), *Science*, **207**: 547-548.

Kalmijn, A.J. (1982) Electric and magnetic field detection in elasmobranch fishes, *Science*, **218** (4575): 916-918.

Kalmijn, A.J. (1977) The electric and magnetic field sense of sharks, skates and rays, *Science*, **218**: 916-918.

Kalmijn, A.J. (1978a) Electric and magnetic sensory world of sharks, skates and rays, *Sensory biology of sharks, skates and rays*, (ed. E.S. Hodgson & R.F. Mathewson), US Government, Arlington, US.

Kalmijn, A.J. (1966) Electro-perception in sharks and rays, *Nature*, **212**: 1232-1233.

Musick, J.A. & McMillan, B. (2002) Eye, Ear, Nose and Snout, In *The Shark Chronicles: A scientist Tracks the Consummate Predator*: 103-124, Times Books, New York.

Smith, E.D. (1973) Electric anti-shark cable, *Civil Engineering and Public Works Review*, **68**: 174-176.

Smith, E.D. (1966) Electrical shark barrier research, *Geo-marine Technology*, **2**: 10-14.

Smith, E.D. (1974) Electro-physiology of the electrical shark repellent, *Transactions of the South African Institute of Electrical Engineers*, **68**: 166-180.

Smith, E.D. (1990) A new perspective on electrical shark barriers, *South African Shipping News and Fishing Industry Review*, **45**: 40-41.

Tricas, T.C. (2001) The neuroecology of the elasmobranch electrosensory world: Why peripheral morphology shapes behavior, *Environmental Biology of Fishes*, **60** (1-3): 77-92.

**Appendix 2b) Chondrichthyan - electroreception - physiology**

Akeov, G.N., Volpe, N.O. & Zhadan, G.G. (1980) Analysis of effects of chemical and thermal stimuli on the ampulla of Lorenzini of skates, *Comparative Biochemical physiology*, **65**: 193-201.

Akoev, G.N., Avelev, V.D. & Semjenkov, P.G. (1995) Reception of Low-intensity Millimeter-wave Electromagnetic Radiation by the Electroreceptors in Skates, *Neuroscience*, **66** (1): 15-17.

Akoev, G.N., Ilyinisky, O.B. & Zadan, P.M. (1976) Physiological properties of electroreceptors of marine skates, *Comparative Biochemical Physiology*, **53** (A): 201-209.

Akoev, G.N., Ilyinsky, O.B. & Zadan, P.M. (1976) Responses of Electroreceptors (Ampullae of Lorenzini) of Skates to Electric and Magnetic Fields, *Journal of Comparative Physiology*, **106** : 127-136.

Andrianov, Y.N., Broun, G.R., Ilinskii, O.B. & Muraveiko, V.M. (1984) Frequency characteristics of skate electroreceptive central neurons responding to electrical and magnetic stimulation, *Neurophysiology*, **16** (4): 364-369.

Aradedda, R.C. & Bennet, M.V.L. (1993) Electrical properties of electroreceptor cells isolated from skate ampullae of Lorenzini, *Biological Bulletin*, **185**: 310-311.

Bennet, M.V. & Clusin, W.T. (1978) Physiology of the ampulla of Lorenzini, the electroreceptor of elasmobranchs, In *Sensory Biology of Sharks, Skates and Rays*, (ed. E.S. Hodgson & R. W. Mathewson): 483-505, Government Printing Office, Washington, DC.

Berquist, R.M. & Paulin, M.G. (2001) The virtual dogfish: an environment for modelling neural computations in cerebellar-like circuitry of the elasmobranch electrosensory system, *Neurocomputing*, **38**: 1107-1112.

Bodznick, D. & Boord, R.L. (1986) Electroreception in Chondrichthyes: central anatomy and physiology, In *Electroreception*, (ed. T.H. Bullock & W. Heiligenberg): 225-256, John Wiley and Sons, New York.

Bodznick, D., Hjelmstad, G. & Bennet, M.V. (1993) Accommodation to maintained stimuli in the ampullae of Lorenzini; how an electroreceptive fish achieves sensitivity in a noisy world, *Japanese Journal of Physiology*, **43** (231-237)

Bodznick, D., Montgomery, J.C. & Bradley, D.J. (1992) Suppression of common mode signals within the electrosensory system of the little skate *Raja erinacea*, *Journal of Experimental Biology*, **202**: 1349-1355.

Bodznick, D., Montgomery, J.C. & Tricas, T.C. (2003) Electroreception: extracting behaviourally important signals from noise, In *Sensory processing in aquatic environments*, (ed. S.P. Collin & N. J. Marshall): 389-403, Springer-Verlag, New York.

Bodznick, D. & Northcutt, R.G. (1984) An electrosensory area in the telencephalon of the little skate, *Raja erinacea*, *Brain Research*, **298**: 117-124.

Bodznick, D. & Schmidt, A.W. (1984) Somatotopy within the medullary electrosensory nucleus of the little skate, *Raja erinacea*, *Journal of Comparative Neurology*, **225** (4): 581-



## COWRIE 1.5 Electromagnetic Fields

590.

Braun, H.A., Wissing, H., Schafer, K. & Hirsch, M.C. (1994) Oscillation and noise determine signal transduction in shark multimodal sensory cells, *Nature*, **367**: 270-273.

Bromm, B., Hensel, H. & Nier, K. (1975) Response of the Ampullae of Lorenzini to Static Combined Electric and Thermal Stimuli in *Scyliorhinus canicula*, *Experientia*, **31**: 615-618.

Broun, G.R., Il'inski, O.B. & Muraveiko, V.M. (1978) Perception of telluric currents due to geomagnetic variations by electroreceptors of the ampullae of Lorenzini of sharks, *Dokl. Akad. Nauk SSSR*, **241** (5): 1228.

Broun, G.R., Il'inskii, O.B. & Muraveiko, V.M. (1979) Perception of electric fields of sea waves by electroreceptors of the ampullae of Lorenzini, *Dokl. Akad. Nauk. SSSR*, **248** (2): 252.

Brown, B.R. (2002) Modeling an electrosensory landscape: behavioral and morphological optimization in elasmobranch prey capture, *Journal of Experimental Biology*, **205** (7): 999-1007.

Brown, B.R., Hutchison, J.C., Hughes, M.E., Kellogg, D.R. & Murray, R.W. (2002) Electrical characterization of gel collected from shark electrosensors, *Physical Review E*, **65** (6): art. no. 061903.

Bruner, L.J. & Harvey, J.R. (1995) The spike generation zone of the ampullary electroreceptor 1. Stimulus-response characteristics of a relaxation oscillator circuit model, *Biological Cybernetics*, **72** (5): 371-378.

Chu, Y.T. & Wen, M.C. (1963) A study of the lateral-line canals system and that of Lorenzini ampullae and tubules of Chondrichthyes fishes of China, In *Monograph of Fishes of China*, Science and Technology Press, Shanghai.

Clusin, W.T. & Bennet, M.V. (1979) The ionic basis of oscillatory responses of skate electroreceptors, *Journal of General Physiology*, **73**: 703-723.

Clusin, W.T. & Bennet, M.V. (1979) The oscillatory responses of skate electroreceptors to small voltage stimuli, *Journal of General Physiology*, **73**: 685-702.

Conley, R.A. & Bodznick, D. (1994) The cerebellar dorsal granular ridge in an elasmobranch has proprioceptive and electroreceptive representations and projects homotopically to the medullary electrosensory nucleus, *Journal of Comparative Physiology A-Sensory Neural and Behavioural Physiology*, **174** (6): 707-721.

Coombs, S., New, J.G. & Nelson, M. (2002) Information processing demands in electrosensory and mechanosensory lateral line systems, *Journal of Physiology Paris*, **96** (5-6): 341-354.

Duman CH & Bodznick D (1996) A role for GABAergic inhibition in electrosensory processing and common mode rejection in the dorsal nucleus of the little skate, *Raja erinacea*, *Journal of Comparative Physiology A-Sensory Neural and Behavioural Physiology*, **179** (6): 797-807.

Fields, R.D., Ellisman, M.H. & Waxman, S.G. (1987) Changes in synaptic morphology

## COWRIE 1.5 Electromagnetic Fields

associated with presynaptic and postsynaptic activity - an in vitro study of the electrosensory organ of the thornback ray, *Synapse*, **1** (4): 335-346.

Fishelson, L. & Baranes, A. (1998) Distribution, morphology, and cytology of ampullae of Lorenzini in the Omen shark, *Iago omanensis* (Triakidae), from the Gulf of Aqaba, Red Sea, *Anatomical Record*, **251** (4): 417-430.

Fishelson, L. & Baranes, A. (1998) Morphological and cytological ontogenesis of the ampullae of Lorenzini and lateral line canals in the Oman Shark, *Iago omanensis* Norman 1939 (Triakidae), from the Gulf of Aqaba, Red Sea, *Anatomical Record*, **252** (4): 532-545.

Gusev, V.M., Krylov, B.V. & Suvorova, T.P. (1986) An analysis of the spatial mechanisms responsible for electrosensitivity in rays - modelling results, *Biological Cybernetics*, **54**: 263-268.

Haine, O.S., Ridd, P.V. & Rowe, R.J. (2001) Range of electrosensory detection of prey by *Carcharhinus melanopterus* and *Himantura granulata*, *Marine and Freshwater Research*, **52** (3): 291-296.

Harvey, J.R. & Bruner, L.J. (1995) The spike generation zone of the ampullary electroreceptor 2. Oscillator period noise and the limits of sensitivity, *Biological Cybernetics*, **72** (5): 379-387.

Heijmen, P.S., Boele, A. & Peters, R.C. (1996) The effect of hyperosmotic treatment on the functioning of ampullary electroreceptor organs, *Neuroscience*, **72**: 1107-1115.

Hjelmstad, G., Parks, G. & Bodznick, D. (1996) Motor corollary discharge activity and sensory responses related to ventilation in the skate vestibulolateral cerebellum; implications for electrosensory processing, *Journal of Experimental Biology*, **199**: 673-681.

Hodgson, E.S. & Mathewson, R.F. (1978) Electrophysiological studies of chemoreception in elasmobranchs, *Sensory Biology of Sharks, Skates, and Rays*, US Government: 227-267, Washington.

Johnson, C.S., Scronce, B.L. & McManus, M.W. (1984) Detection of DC electric dipoles in background fields by the nurse shark, *Journal of Comparative Physiology*, **155** (5): 681-687.

Kajiura, S.M. (2001) Head morphology and electrosensory pore distribution of carcharhinid and sphyrnid sharks, *Environmental Biology of Fishes*, **61** (2): 125-133.

Kalmijn, A.J. (2000) Detection and processing of electromagnetic and near-field acoustic signals in elasmobranch fish, *Philosophical Transactions of the Royal Society of London*, **355**: 1135-1141.

Kalmijn, A.J. (1974) The detection of electric fields from inanimate and animate sources other than electric organs, In *Electroreceptors and other Specialized Receptors in Lower Vertebrates*, (ed. A. Fessard), Springer-Verlag, New York.

Kalmijn, A.J. (1988) Detection of weak electric fields, In, (ed. J. Atema, R. R. Fay, A. N. Popper & W. N. Tavolga): 151-186, Springer-Verlag, New York.

Kalmijn, A.J. (1997) Electric and near-field acoustic detection, a comparative study, *Acta physiologica scandinavica*, **161**: 25-38.

## COWRIE 1.5 Electromagnetic Fields

- Kalmijn, A.J. (1971) The electric sense of sharks and rays, *Journal of Experimental Biology*, **55** (2): 371-383.
- Kalmijn, A.J., Gonzalez, I.F. & McClune, M.C. (2002) The physical nature of life, *Journal of Physiology-Paris*, **96** (5-6): 355-362.
- Lu, J. & Fishman, H.M. (1994) Interaction of apical and basal membrane ion channels underlies electroreception in ampullary epithelia of skates, *Biophysical Journal*, **67** (4): 1525-1533.
- Lu, J. & Fishman, H.M. (1995a) Ion channels and transporters in the electroreceptive ampullary epithelium from skates, *Biophysical Journal*, **69**: 2467-2475.
- Lu, J. & Fishman, H.M. (1995b) Localization and function of the electrical oscillation in electroreceptive ampullary epithelium from skates, *Biophysical Journal*, **69**: 2458-2466.
- Montgomery, J.C. (1984b) Frequency response characteristics of primary and secondary neurons in the electrosensory system of the thornback ray, *Comparative Biochemistry and Physiology*, **79** (1): 189-195.
- Montgomery, J.C. (1984a) Noise cancellation in the electrosensory system of the thornback ray; common mode rejection of input produced by the animal's own ventilatory movement, *Journal of Comparative Physiology*, **155**: 103-111.
- Montgomery, J.C. & Bodznick, D. (1994) An adaptive filter that cancels self-induced noise in the electrosensory and lateral line mechanosensory systems of fish, *Neuroscience Letters*, **174**: 145-148.
- Montgomery, J.C. & Bodznick, D. (1993) Hindbrain circuitry mediating common mode suppression of ventilatory reafference in the electrosensory system of the little skate *rajá erinacea*, *Journal of Experimental Biology*, **183**: 203-215.
- Montgomery, J.C. & Bodznick, D. (1999) Signals and noise in the elasmobranch electrosensory system, *Journal of Experimental Biology*, **202** (10): 1349-1355.
- Murray, R.W. (1974) The ampullae of Lorenzini, In *Electroreceptors and other specialized organs in lower vertebrates*, (ed. A. Fessard): 125-146, Springer-Verlag, New York.
- Murray, R.W. (1960) Electrical sensitivity of the ampullae of Lorenzini, *Nature*, **187**: 957.
- Murray, R.W. (1962) The response of the Ampullae of Lorenzini of elasmobranchs to electrical stimulation, *Journal of Experimental Biology*, **39**: 119-128.
- Nelson, M.E. & Paulin, M.G. (1995) Neural simulations of adaptive reafference suppression in the elasmobranch electrosensory system, *Journal of Comparative Physiology*, **177**: 723-736.
- New, J.G. (1994) Electric organ discharge and electrosensory reafference in skates, *Biological Bulletin*, **187** (1): 64-75.
- New, J.G. (1990) Medullary electrosensory processing the little skate 1. Response characteristics of neurons in the dorsal octavolateralis nucleus, *Journal of Comparative Physiology A-Sensory Neural and Behavioural Physiology*, **167** (2): 285-294.

## COWRIE 1.5 Electromagnetic Fields

- New, J.G. & Bodznick, D. (1990) Medullary electrosensory processing the little skate 2. Suppression of self-generated electrosensory interference during respiration, *Journal of Comparative Physiology A-Sensory Neural and Behavioural Physiology*, **167** (2): 295-307.
- Obara, S. & Bennet, M.V.C. (1972) Mode of operation of Ampullae of Lorenzini of the skate, *Raja*, *Journal of General Physiology*, **60**: 534-557.
- Peters, R.C. & Evers, H.P. (1985) Frequency-selectivity in the ampullary system of an elasmobranch fish (*Scyliorhinus canicula*), *Journal of Experimental Biology*, **118**: 99-109.
- Petracchi, D. & Cerignani, G. (1998) A comment on the sensitivity of fish to low electric fields, *Biophysical Journal*, **75** (4): 2117-2118.
- Pickard, W.F. (1988) A model for the acute electrosensitivity of cartilaginous fishes, *IEEE Transactions on Biomedical Engineering*, **35** (4): 243-250.
- Raschi, W. (1986) A morphological analysis of the ampullae of Lorenzini in selected skates (Pisces, Rajoidei), *Journal of Morphology*, **189** (3): 225-247.
- Raschi, W. (1978) Notes on the gross functional morphology of the ampullary system in two similar species of skates, *Raja erinacea* and *R. ocellata*, *Copeia*, **1**: 48-53.
- Raschi, W., Aadlond, C. & Keithar, E.D. (2001) A morphological and functional analysis of the ampullae of Lorenzini in selected Galeoid sharks, In *Sensory Biology of Jawed Fishes - New Insights*, (ed. B.G. Kapoor & T. J. Hara): 297-316, Science Publishers Inc., Enfield, NH, USA.
- Raschi, W. & Adams, W.H. (1988) Depth-related modifications in the electroreceptive system of the eurybathic skate, *Raja radiata* (Chondrichthyes, Rajidae), *Copeia*, **1**: 116-123.
- Raschi, W. & Mackanos, L.A. (1987) Evolutionary trends in the peripheral component of chondrichthyan electroreceptors - a morphological review, *Archives of Biology*, **98** (2): 163-186.
- Salypongse, A., Hjelmstad, G. & Bodznick, D. (1992) Second order electroreceptive cells in skates have response properties dependent on the configuration of their inhibitory receptive fields, *Biological Bulletin*, **183**: 349.
- Schweitzer, J. (1986) Functional organisation of the electroreceptive midbrain in an elasmobranch (*Platyrrhinoidis triseriata*) - a single unit study, *Journal of Comparative Physiology A-Sensory Neural and Behavioural Physiology*, **158** (1): 43-58.
- Schweitzer, J. (1983) The physiological and anatomical localization of two electroreceptive diencephalic nuclei in the thornback ray, *Platyrrhinoidis triseriata*, *Journal of Comparative Physiology*, **153** (3): 331-341.
- Sisneros, J.A. & Tricas, T.C. (2000) Androgen-induced changes in the response dynamics of ampullary electrosensory primary afferent neurons, *Journal of Neuroscience*, **20** (22): 8586.
- Sisneros, J.A. & Tricas, T.C. (2002) Neuroethology and life history adaptations of the elasmobranch electric sense, *Journal of Physiology-Paris*, **96** (5-6): 379-389.
- Sisneros, J.A. & Tricas, T.C. (2002) Ontogenic changes in the response properties of the

## COWRIE 1.5 Electromagnetic Fields

peripheral electrosensory system in the Atlantic stingray (*Dasyatis sabina*), *Brain Behaviour and Evolution*, **59** (3): 130-140.

Sisneros, J.A., Tricas, T.C. & Luer, C.A. (1998) Response properties and biological function of the skate electrosensory system during ontogeny, *Journal of Comparative Physiology A*, **183** (1): 87-99.

Szabo, T. (1974) Anatomy of the specialized lateral line organs of electroreception, In *Electroreceptors and other specialized receptors of lower vertebrates*, (ed. A. Fessard): 13-58, Springer-Verlag, New York.

Tricas, T.C. (1982) Bioelectric mediated predation by swell sharks, *Cephaloscyllium ventriosum*, *Copeia*, **4**: 948-952.

Tricas, T.C., Michael, S.W. & Sisneros, J.A. (1995) Electrosensory optimization to conspecific phasic signals for mating, *Neuro-science Letters*, **202**: 129-132.

Tricas, T.C. & New, J.G. (1998) Sensitivity and response dynamics of elasmobranch electrosensory primary afferent neurons to near threshold fields, *Journal of Comparative Physiology A*, **182** (1): 89-101.

Tsong, T.Y. (1994) Exquisite sensitivity of electroreceptor in skates, *Biophysical Journal*, **67**: 1367-1368.

Waltman, B. (1966) Electrical properties and fine structure of the ampullary canals of Lorenzini, *Acta Physiologica Scandinavica*, **264**: 1-60.

Whitehead, D.L. (2002) Ampullary organs and electroreception in freshwater *Carcharhinus leucas*, *Journal of Physiology-Paris*, **96** (5-6): 391-395.

Wissing, H., Braun, H.A. & Schafer, K. (1988) Dynamic response characteristics of the ampullae of Lorenzini to thermal and electrical stimuli, *Progresses in Brain Research*, **74**: 99-110.

**Appendix 2c) Chondrichthyans - electroreception - behaviour**

Blonder, B.I. & Alevizon, W.S. (1988) Prey discrimination and electroreception in the stingray *Dasyatis sabina*, *Copeia*, **1**: 33-36.

Chung, P. (2001) Ontogenic changes in electroreception by rays, Unpublished BSc thesis, University of Liverpool.

Dawson, B.G., Heyes, G.W., Eppi, R.E. & Kalmijn, A.J. (1980) Field experiments on electrically evoked feeding responses in the dogfish shark, *Mustelus canis*, *Biological Bulletin*, **159** (2): 482.

Heyer, G.W., Fields, M.C., Fields, R.D. & Kalmijn, A.J. (1981) Field experiments on electrically evoked feeding responses in the pelagic blue shark, *Prionace glauca*, *Biological Bulletin*, **161**: 345-346.

Kajiura, S.M. (2003) Electroreception in neonatal bonnethead sharks, *Sphyrna tiburo*, *Marine Biology*, **143** (3): 603-611.

Kajiura, S.M. & Holland, K.N. (2002) Electroreception in juvenile scalloped hammerhead and sandbar sharks, *Journal of Experimental Biology*, **205** (23): 3609-3621.

Kalmijn, A.J. & Kalmijn, V. (1981) Orientation to uniform electric fields in the stringray *Urolophus halleri*: Sensitivity of response, *Biological Bulletin*, **161**: 347.

Kalmijn, A.J. & Weinger, M.B. (1981) An electrical Simulator of moving prey for the study of feeding strategies in sharks, skates and rays, *Annals of Biomedical Engineering*, **9** (4): 363-367.

Linsey, T. (99) Electroreception and foraging behaviour in captive bonnethead sharks, *Sphyrna tiburo* (L.), Unpublished BSc thesis, University of Liverpool.

Pals, N., Valentijn, P. & Verwey, D. (1982) Orientation reactions of the dogfish, *Scyliorhinus canicula*, to local electric fields, *Netherlands Journal of Zoology*, **32** (4): 495-512.

Ryan, P.R. (1981) Electroreception in blue sharks, *Oceanus*, **24** (4): 42-44.

Whitworth, L. (2000) Electroreception in elasmobranchs, Unpublished BSc thesis, University of Liverpool.

**Appendix 3a) Chondrichthyans - magnetoreception - general**

Brown, H.R., Andrianov, G.N. & Ilyinsky, O.B. (1974) Magnetic field perception by electroreceptors in Black Sea skates, *Nature*, **249**: 178-179.

Clermont, S.M. & Gruber, S.H. (1998) Experimental homing in juvenile lemon sharks, *Negaprion brevirostris*, at Bimini, Bahamas, In *American Elasmobranch Society Meeting Program and Abstracts*, Abstract No. 369, Ontario, Canada.

Clermont S. M., Gruber S. H., and Lund, A. (In press) Young lemon sharks (*Negaprion brevirostris*) possess homing ability, *Marine Biology*.

Kalmijn, A.J. (1988) Electromagnetic orientation: a relativistic approach, In *Electromagnetic fields and neurobehavioural function*, (ed. M. O'Connor & R. H. Lovely): 23-45, Liss, New York.

Meyer, C.G., Holland, K.N. & Papastamatiou, Y.P. (2004) Sharks can detect changes in the geomagnetic field, *Journal of the Royal Society Interface*, (DOI: 10.1098/rsif.2004.0021 FirstCite): 2pp.

Montgomery, J.C. & Walker, M.M. (2001) Orientation and navigation in elasmobranchs: which way forward?, *Environmental Biology of Fishes*, **60**: 109-116.

Paulin, M.G. (1995) Electroreception and the compass sense of sharks, *Journal of Theoretical Biology*, **174** (3): 325-339.

Quinn, T.P. (1994) How do sharks orient at sea? *Trends in Ecology and Evolution*, **9** (8): 277-278.

**Appendix 3b) Chondrichthyans - magnetoreception - physiology**

Brown, H.R. & Ilyinsky, O.B. (1978) The ampullae of Lorenzini in the magnetic field, *Journal of Comparative Physiology*, **126**: 333-341.

Kalmijn, A.J. (1981) Biophysics of geomagnetic field detection, *IEEE Trans Magn*, **17**: 1113-1124.

Kalmijn, A.J. (1984) Theory of electromagnetic orientation: A further analysis, *Comparative Physiology of Sensory Systems*: 525-560.



**Appendix 3c) Chondrichthyans - magnetoreception - behaviour**

Kalmijn, A.J. (1978b) Experimental evidence of geomagnetic orientation in elasmobranch fishes, In *Animal migration, navigation and homing*, (ed. K. Schmidt-Koenig & W. T. Keeton): 347-353, Springer-Verlag, New York.

Klimley, A.P. (1993) Highly directional swimming by scalloped hammerhead sharks, *Sphyrna lewini*, and subsurface irradiance, temperature, bathymetry and geomagnetic field, *Marine Biology*, **117** (1): 1-22.

**Appendix 4a) Other organisms - electroreception - general**

Adair, R.K. (1991) Constraints on biological effects of weak extremely low frequency electromagnetic fields, *Physical Review A*, **43** (2): 1039-1048.

Adair, R.K. (1993) Constraints on biological effects of weak extremely low frequency electromagnetic fields, *Physical Review E*, **47** (5): 3803-3803.

Adair, R.K. (1992) Reply to comments on Constraints on biological effects of weak extremely low frequency electromagnetic fields, *Physical Review A*, **46** (4): 2185-2187.

Bemis, W.E., Findeis, E.K. & Grande, L. (1997) An overview of Acipenseriformes, *Environmental Biology of Fishes*, **48**: 25-71.

Bullock, T.H. (1982) Electroreception, *Annual Review of Neuroscience*, **5**: 121-170.

Bullock, T.H. (1999) The Future of Research on Electroreception and Electrocommunication, *Journal of Experimental Biology*, **202**: 1455-1458.

Bullock, T.H. (1973) Seeing the world through a new sense: electroreception in fish, *Am Science*, **63**: 316-325.

Bullock, T.H., Bodznick, D.A. & Northcutt, R.G. (1983) The phylogenetic distribution of electroreception: evidence for convergent evolution of a sense modality, *Brain Research*, **287**: 25-46.

Collin, S.P. & Whitehead, D. (2004) The functional roles of passive electroreception in non electric fishes, *Animal Biology*, **54** (1): 1-25.

Francis, J.T., Gluckman, B.J. & Schiff, S.J. (2003) Sensitivity of neurons to weak electric fields, *The Journal of Neuroscience*, **23** (19): 7255-7261.

Holliman, F.M. & Reynolds, J.B. (2002) Electroshock injury in juvenile white sturgeon, *North American Journal of Fisheries Management*, **22** (2): 494-499.

Kirschvink, J.L. (1992) Comment on 'Constraints on biological effects of weak extremely low frequency electromagnetic fields', *Phys Rev A*, **46** (4): 2178-2184.

Kirschvink, J.L. (1993) Comment on 'Constraints on biological effects of weak extremely low frequency electromagnetic fields', *Phys Rev E*, **47** (5): 3803-3803.

Letovanec, P. (2001) The impact of electromagnetic fields on living organisms and their communities, *Ekologia-Bratislava*, **20** (4): 382-386.

Leya, T., Rother, A., Müller, T., Fuhr, G., Gropius, M. & Watermann, B. (1999) Electromagnetic antifouling shield (EMAS) – a promising novel antifouling technique for optical systems, *10<sup>th</sup> International Congress on Marine Corrosion and Fouling*, University of Melbourne, February 1999.

Lovely, R.H. (1988) Recent studies in the behavioural toxicology of ELF fields and magnetic fields, *Prog Clin Biol Res*, **257**: 327-347.

## COWRIE 1.5 Electromagnetic Fields

McCleave, J.D., Rommel, S.A. & Cathcart, C.J. (1971) Weak electric and magnetic fields in fish orientation, *Ann. N.Y. Acad. Sci.*, **188**: 270-282.

Miller, M.W. (1986) Extremely low frequency electric fields: experimental work on biological effects, In *CRC Handbook of Biological Effects of Electromagnetic Fields*, (ed. C. Polk & E. Postow): 139-168.

New, J.G. (1997) The evolution of vertebrate electrosensory systems, *Brain Behaviour and Evolution*, **50** (4): 244-252.

Northcutt, R.G. (1986) Electroreception in nonteleost bony fishes, In *Electroreception*, (ed. T.H. Bullock & W. Heiligenberg): 257-285, Wiley Interscience, New York.

Pals, N., Peters, R.C. & Schoenhage, A.A.C. (1982) Local geo-electric fields at the bottom of the sea and their relevance for electrosensitive fish, *Netherlands Journal of Zoology*, **32** (4): 479-494.

Regnart, H.C. (1931) The lower limits of perception of electric currents by fish, *Journal of the Marine Biological Association UK*, **17**: 415-420.

Rommel, S.A. & McCleave, J.D. (1972) Oceanic electric fields: perception by American Eels? *Science*, **176** (4040): 1233-1235.

Tenforde, T.S. (1989) Electroreception and magnetoreception in simple and complex organisms, *Bioelectromagnetics*, **10** (3): 215-221.

von der Emde, G. (1998) Electroreception, In *The Physiology of Fishes*, (ed. D.H. Evans): 313-343, CRC press.

Weaver, J.C., Vaughan, T.E. & Martin, G.T. (1999) Biological effects due to weak electric and magnetic fields: the temperature variation threshold, *Biophysical Journal*, **76** (6): 3026-3030.

Zakon, H.H. (1986) The electroreceptive periphery, In *Electroreception*, (ed. T.H. Bullock & W. Heiligenberg): 103-156, John Wiley and Sons, New York.

Zakon, H.H. (1988) The electroreceptors: diversity in structure and function, In *Sensory Biology of Aquatic Animals*, (ed. J. Atema, R. R. Fay, A. N. Popper & W. N. Tavolga): 813-850, Springer-Verlag, New York.

**Appendix 4b) Other organisms - electroreception - physiology**

- Adair, R.K. (2001) Simple neural networks for the amplification and utilization of small changes in neural firing rates, In *Proceedings National Academy Sciences USA*: 7253-7258.
- Akeov, G.N. & Muraveiko, V.M. (1984) Physiological properties of lateral line receptors of the lamprey, *Neuroscience Letters*, **49** (1-2): 171-173.
- Bennett, M.V.L. (1971b) Electroreception, In *Fish Physiology: sensory systems and electric organs*, (ed. W.S. Hoar & Randall. D.J.): 493-574, Academic Press, New York.
- Berge, J.A. (1979) The perception of weak electric AC currents by the European eel, *Anguilla anguilla*, *Comparative Biochemistry and Physiology*, **62A**: 915-919.
- Bodznick, D. & Northcutt, R.G. (1981) Electroreception in lampreys - evidence that the earliest vertebrates were electroreceptive, *Science*, **212** (4493): 465-467.
- Bodznick, D. & Preston, D.G. (1983) Physiological characterization of electroreceptors in the lampreys *Ichthyomyzon unicuspis* and *Petromyzon marinus*, *Journal of Comparative Physiology A*, **152** (2A): 209-217.
- Bullock, T.H., Northcutt, R.G. & Bodznick, D.A. (1982) Evolution of electroreception, *Trends in Neuroscience*, **5**: 50-53.
- Chung-Davidson, Y.W., Yun, S.S., Teeter, J. & Li, W.M. (2004) Brain pathways and behavioral responses to weak electric fields in parasitic sea lampreys (*Petromyzon marinus*), *Behavioural Neuroscience*, **118** (3): 611-619.
- Enger, P.S. (1992) Electroreception, In *Fish Physiology*, (ed. K. Daving & E. Reimers), John Grieg Publishing, Bergen, Norway.
- Enger, P.S., Kristensen, L. & Sand, O. (1976) The perception of weak electric D.C. currents by the European eel (*Anguilla anguilla*), *Comparative Biochemistry and Physiology*, **54A**: 101-103.
- Frey, A.H. & Eichert, E.S. (1988) An analytical model of the electrosensory system of the fish, *Journal of Bioelectricity*, **7** (1): 1-32.
- Fritsch, B., Decaprona, M.D.C., Wachtler, K. & Kortje, K.H. (1984) Neuroanatomical evidence for electroreception in lampreys, *Zeitschrift Fur Naturforschung C-A Journal of Biosciences*, **39** (7-8): 856-858.
- Gibbs, M.A. (2004) Lateral line receptors: Where do they come from developmentally and where is our research going? *Brain Behaviour and Evolution*, **64** (3): 163-181.
- Jorgensen, J.M. (1980) The morphology of the Lorenzinian ampullae of the sturgeon *Acipenser ruthenus* (PiscesL Chondros-tei), *Acta Zool*, **61** (87-92)
- Kishida, R., Koyama, H. & Goris, R.C. (1988) Giant lateral-line terminals in the electroreceptive dorsal nucleus of lampreys, *Neuroscience Research*, **6** (1): 83-87.
- Koyama, H., Kishida, R., Goris, R. & Kusunoki, T. (1993) Giant Terminals in the dorsal octavolateralis nucleus of lampreys, *Journal of Comparative Neurology*, **335** (2): 245-251.

## COWRIE 1.5 Electromagnetic Fields

- Moller, P. & Fritzschn, B. (1993) History of electroreception. From electroreception to electroreception: the problem of understanding a non-human sense, *Journal of Comparative Physiology*, **173**: 734-737.
- New, J.G. & Bodznick, D. (1985) Segregation of electroreceptive and mechanoreceptive lateral line afferents in the hindbrain of chondrosteian fishes, *Brain Research*, **336** (1): 89-98.
- Ronan, M. (1988) Anatomical physiological evidence for electroreception in larval lampreys, *Brain Research*, **448** (1): 173-177.
- Ronan, M.C. & Bodznick, D. (1986) End buds: non-ampullary electroreceptors in adult lampreys, *Journal of Comparative Physiology A*, **158** (1): 9-15.
- Valberg, P.A., Kavet, R. & Rafferty, C.N. (1997) Can low level 50/60 Hz electric and magnetic fields cause biological effects, *Radiation Research*, **148** (1): 2-21.
- Vriens, A.M. & Bretschneider, F. (1979) The electrosensitivity of the lateral line of the European eel, *Anguilla anguilla*, *Journal of Physiology Paris*, **75**: 341-342.
- Weaver, J.C., Vaughan, T.E., Adair, R.K. & Astumian, R.D. (1998) Theoretical limits on the threshold for the response of long cells to weak extremely low frequency electric fields due to ionic and molecular flux rectification, *Biophysical Journal*, **75** (5): 2251-2254.

**Appendix 4c) Other organisms - electroreception - behaviour**

Bowen, A.K., Weisser, J.W., Bergstedt, R.A. & Famoye, F. (2003) Response of larval sea lampreys (*Petromyzon marinus*) to pulsed DC electrical stimuli in laboratory experiments, *Journal of Great Lakes Research*, **29**: 174-182.

Gertseva, V.V. & Gertsev, V.I. (2001) A model of fish population distribution in the space of inhabitation, *Ecological Modelling*, **147**: 161-170.

Poddubny, A.G. (1967) Sonic tags and floats as a means of studying fish response to natural environmental changes to fishing gears, In *Conference on fish behaviour in relation to fishing techniques and tactics*, Bergen, Norway: 793-802, FAO, Rome.

Zimmerman, M.A. & McCleave, J.D. (1975) Orientation of elvers of American eels (*Anguilla rostrata*) in weak magnetic and electric fields, *Helgolander wiss. Meeresunters*, **27**: 175-189.

**Appendix 5a) Other organisms - magnetoreception - general**

- Able, K.P. (1991) Common themes and variations in animal orientation systems, *Am Zool*, **31**: 157-167.
- Akesson, S., Luschi, P., Papi, F., Broderick, A.C., Glen, F., Godley, B.J. & Hays, G.C. (2001) Oceanic long-distance navigation: Do experienced migrants use the Earth's magnetic field? *Journal of Navigation*, **54** (3): 419-427.
- Anon (1984) Magnetic attraction behind whale migration, *New Scientist*, **104** (1434): 7.
- Arnold, G.P. & Metcalf, J.D. (1989) Fish migration: orientation and navigation or environmental transport? *Journal of Navigation*, **42**: 367-374.
- Becker, R.O. (1985) A theory of the interaction between DC and ELF electromagnetic fields and living organisms, *Journal of Bioelectricity*, **4** (1): 133-140.
- Bochert, R. & Zettler, M.L. (2004) Long-term exposure of several marine benthic animals to static magnetic fields, *Bioelectromagnetics*, **25**: 498-502.
- Cameron, I.L., Hunter, K.E. & Winters, W.D. (1985) Retardation of embryogenesis by extremely low frequency 60 Hz electromagnetic fields, *Physiological chemistry and physics and medical NMR*, **17**: 135-138.
- Cameron, I.L., Hardman, W.E., Winters, W.D., Zimmerman, S. & Zimmerman, A.M. (1993) Environmental magnetic fields: influences on early embryogenesis, *Journal of Cell Biochemistry*, **51**: 417-425.
- Courtillot, V., Hulot, G., Alexandrescu, M., le Mouel, J.L. & Kirschvink, J.L. (1997) Sensitivity and evolution of sea-turtle magnetoreception: observations, modelling and constraints from secular variation, *Terra Nova*, **9**: 203-207.
- Frankel, R.B. (1984) Magnetic guidance of organisms, *Annual Review of Biophysics and Bioengineering*, **13** (85-103)
- Gould, J.L. (1998) Sensory bases of navigation, *Current Biology*, **8** (20): 731-738.
- Griffin, D.R. (1982) Ecology of migration; is magnetic orientation a reality? *Quart Rev Biol*, **57**: 292-295.
- Herrnkind, W.F. (1983) Movement patterns and orientation, In *The biology of Crustaceans: Behaviour and Ecology*, (ed. F.J. Vernberg & W. B. Vernberg): 41-105, Academic Press, New York.
- Hui, C.A. (1994) Lack of association between magnetic patterns and the distribution of free-ranging dolphins, *Journal of Mammalogy*, **75** (2): 399-405.
- Kirschvink, J.L. (1990) Geomagnetic sensitivity in cetaceans: an update with live stranding records in the United States, In *Sensory Abilities of Cetaceans Laboratory and Field Evidence*, (ed. J.A. Thomas & R. A. Kastelein): 639-649, Plenum Publishing Corporation, New York.

## COWRIE 1.5 Electromagnetic Fields

- Kirschvink, J.L. (1997) Magnetoreception: homing in on vertebrates, *Nature*, **390**: 339-340.
- Kirschvink, J.L., Dizon, A.E. & Westphal, J.A. (1986) Evidence from strandings for geomagnetic sensitivity in cetaceans, *Journal of Experimental Biology*, **120**: 1-24.
- Klinowska, M. (1985) Cetacean live stranding dates relate to geomagnetic field disturbances, *Aquatic Mammals*, **11** (3): 109-119.
- Klinowska, M. (1985) Cetacean live stranding sites relate to geomagnetic topography, *Aquatic Mammals*, **11** (1): 27-32.
- Klinowska, M. (1986) Cetacean magnetic sense - evidence from stranding, In *Research on dolphins*, (ed. M.M. Bryden & R. Harrison): 401-432, Clarendon Press, Oxford.
- Klinowska, M. (1988) Cetacean 'navigation' and the geomagnetic field, *Journal of Navigation*, **41** (1): 52-71.
- Klinowska, M. (1985a) Is the cetacean map geomagnetic? *Aquatic Mammals*, **10**: 15.
- Kobayashi, A. & Kirschvink, J.L. (1995) Magnetoreception and electromagnetic field effects: Sensory perception of the geomagnetic field in animals and humans, *Electromagnetic Fields*, **250**: 367-394.
- Limpus, C.J., Miller, J.D., Parmenter, C.J., Reimer, D., McLachland, N. & Webb, R. (1992) Migration of green (*Chelonia mydas*) and loggerhead (*Caretta caretta*) turtles to and from eastern Australian rookeries, *Wildlife Research*, **19**: 347-358.
- Lohmann, K.J. (1993) Magnetic compass orientation, *Nature*, **362**: 703.
- Lohmann, K.J., Caine, S.D., Dodge, S.A. & Lohmann, C.M.F. (2001) Regional magnetic fields as navigational markers for sea turtles, *Science*, **294** (5541): 364-366.
- Lohmann, K.J., Hester, J.T. & Lohmann, C.M.F. (1999) Long-distance navigation in sea turtles, *Ethol Ecol Evol*, **11**: 1-23.
- Lohmann, K.J. & Lohmann, C.M.F. (1996) Detection of magnetic field intensity by sea turtles, *Nature*, **380**: 59-61.
- Lohmann, K.J. & Lohmann, C.M.F. (1993) A light-independent magnetic compass in the leatherback sea turtles, *Biological Bulletin*, **185**: 149-151.
- Papi, F. (2001) Animal navigation at the end of the century: a retrospect and a look forward, *Italian Journal of Zoology*, **68** (3): 171-180.
- Quinn, T.P. (1984) An experimental approach to fish compass and map orientation, In *Mechanisms of Migration in Fishes*, (ed. J.D. McCleave, G. P. Arnold, J. J. Dodson & W. H. Neill): 113-123, Plenum Publishing Corporation, New York.
- Roitblat, H.L. (1990) Concluding comments on other sensory abilities, In *Sensory Abilities of Cetaceans*, (ed. J.A. Thomas & R. A. Kastelein): 699-702, Plenum Publishing Corporation, New York.



## COWRIE 1.5 Electromagnetic Fields

Skiles, D.D. (1982) The geomagnetic field: its nature, history and biological relevance, In *Magnetite Biomineralisation and Magnetoreception in Organisms*, (ed. J.L. Kirschvink *et al.*): 43-102, Plenum Press Corporation, New York.

Strand, J.A., Abernethy, C.S., Skalski, J.R. & Genoway, R.G. (1983) Effects of magnetic field exposure on fertilisation success in rainbow trout *Salmo gairdneri*, *Bioelectromagnetics*, **4**: 295.

Walker, M.M., Dennis, T.E. & Kirschvink, J.L. (2002) The magnetic sense and its use in long-distance navigation by animals, *Current Opinion in Neurobiology*, **12**: 735-744.

Walker, M.M., Diebel, C.E., Haugh, C.V., Pankhurst, P.M., Montgomery, J.C. & Green, C.R. (1997) Structure and function of the vertebrate magnetic sense, *Nature*, **390**: 371-376.

Walker, M.M., Diebel, C.E. & Kirschvink, J.L. (2001) Detection and use of the earth's magnetic field by aquatic vertebrates, In *Proceedings SPAE Conference*.

Weisburd, S. (1984) Whales and dolphins use magnetic roads, *Science News*, **126** (25-2): 391-391.

Zimmermann, S., Zimmermann, A.M., Winters, W.D. & Cameron, I.L. (1990) Influence of 60-Hz magnetic fields on sea urchin development, *Bioelectromagnetics*, **11**: 37-45.

**Appendix 5b) Other organisms - magnetoreception - physiology**

- Azana, M.J. & Delmoral, A. (1994) Cell-membrane biochemistry and neurobiological approach to biomagnetism, *Progress in Neurobiology*, **44** (6): 517-601.
- Diebel, C.E., Proksch, R., Green, C.R., Neilson, P. & Walker, M.M. (2000) Magnetite defines a vertebrate magnetoreceptor, *Nature*, **406** (6793): 299-302.
- Gould, J.L. (1980) Magnetic field sensitivity in animals, *Annual Reviews in Physiology*, **46**: 585-598.
- Kirschvink, J.L. (1983) Biomagnetic geomagnetism, *Reviews of Geophysics*, **21** (3): 672-675.
- Kirschvink, J.L. (1989) Magnetite biomineralisation and geomagnetic sensitivity in animals; an update and recommendations for future studies, *Bioelectromagnetics*, **10**: 239-259.
- Kirschvink, J.L., Brassart, J. & Nesson, M.H. (1998) Magnetite-based biological effects in animals, (ed. C. Rafferty & C.A. Palo Alto), Electrical Power Research Institute, TR-111901.
- Kirschvink, J.L. & Gould, J.L. (1981) Biogenic magnetite as a basis for magnetic field detection in animals, *Biosystems*, **13**: 181-201.
- Kirschvink, J.L., Walker, M.M. & Diebel, C.E. (2001) Magnetite-based magnetoreception, *Current Opinion in Neurobiology*, **11**: 462-467.
- Levin, M. & Ernst, S.G. (1997) Applied DC magnetic fields cause alterations in the time of cell divisions and developmental abnormalities in early sea urchin embryos, *Bioelectromagnetics*, **18**: 255-263.
- Lohmann, K.J. (1985) Geomagnetic field detection by the western Atlantic spiny lobster, *Panulirus argus*, *Marine Behaviour and Physiology*, **12** (1): 1-17.
- Lohmann, K.J. & Johnsen, S. (2000) The neurobiology of magnetoreception in vertebrate animals, *Trends in Neuroscience*, **23**: 153-159.
- Lohmann, K.J., Willows, A.O. & Pinter, R.B. (1991) An identifiable molluscan neuron responds to changes in earth-strength magnetic fields, *Journal of Experimental Biology*, **161**: 1-24.
- Mann, S., Sparks, N.H.C., Walker, M.M. & Kirschvink, J.L. (1988) Ultrastructure, morphology and organisation of biogenic magnetite from sockeye salmon, *Oncorhynchus nerka*; implications for magnetoreception, *Journal of Experimental Biology*, **140**: 35-49.
- Moore, A., Freake, S.M. & Thomas, I.M. (1990) Magnetic particles in the lateral line of Atlantic salmon (*Salmo salar* L.), *Philosophical Transactions of the Royal Society B*, **329**: 11-15.
- Mora, C.V., Davison, M.J., Wild, M. & Walker, M.M. (2004) Magnetoreception and its trogeminal mediation in the homing pigeon, *Nature*, **432**: 508-511.
- Pagnac, C., Genevriere, A.M., Moreau, J.M., Picard, A., Jousset-Dubien, J. & Veyret, B. (1998) No effects of DC and 60-Hz AC magnetic fields on the first mitosis of two species of sea urchin embryos, *Bioelectromagnetics*, **19**: 494-497.

## COWRIE 1.5 Electromagnetic Fields

Peplow, M. (2004) Magnetic field benefits bacteria: weak magnetism shown to affect chemical reactions inside cells, *Nature News*, (doi:10.1038/news041122-13 ): 1.

Rosenblum, B.e.a. (1985) Limits to induction-based magnetoreception, In *Magnetite Biomineralisation and Magnetoreception in organisms*, (ed. J.L. Kirschvink *et al.*): 365-384, Plenum Press Corporation, New York.

Schulten, K. & Windemuth, A. (1986) Model for a physiological magnetic compass, In *Biophysical effects of steady magnetic fields*, (ed. G. Maret): 99-106, Springer-Verlag.

Ueda, K., Maeda, Y., Koyama, M., Yaskawa, K. & Tokui, T. (1986) Magnetic remanences in salmonid fish, *Bulletin of the Japanese Society of Scientific Fisheries*, **52** (2): 193-198.

Walker, M.M. (1984) Learned magnetic field discrimination in yellowfin tuna, *Thunnus albacares*, *Journal of Comparative Physiology*, **155** (5): 673-679.

Walker, M.M., Kirschvink, J.L., Chang, S.B.T. & Dizon, A.E. (1984) A candidate magnetic sense organ in the yellowfin tuna, *Thunnus albacares*, *Science*, **224**: 751-753.

Walker, M.M., Quinn, T.P., Kirschvink, J.L. & Groot, T. (1988) Production of single-domain magnetite throughout life by sockeye salmon, *Oncorhynchus nerka*, *Journal of Experimental Biology*, **140** (51-63)

Wang, J.H., Cain, S.D. & Lohmann, K.J. (2004) The identification and characterization of magnetically sensitive neurons in the marine mollusc *Tritonia diomedea*, *Journal of Experimental Biology*, **206**: 381-388.

Weaver, J.C., Vaughan, T.E. & Astumain, R.D. (2000) Biological sensing of small field differences by magnetically sensitive chemical reactions, *Nature*, **405**: 707-709.

Zoeger, J., Dunn, J.R. & Fuller, M. (1981) Magnetic material in the head of a common Pacific dolphin, *Science*, **213**: 892-894.

**Appendix 5c) Other organisms - magnetoreception - behaviour**

Akesson, S., Broderick, A.C., Glen, F., Godley, B.J., Luschi, P., Papi, F. & Rays, G.C. (2003) Navigation by green turtles; which strategy do displaced adults use to find Ascension Island? *Oikos*, **103** (2): 363-372.

Alerstam, T. (2003) Animal behaviour - The lobster navigators, *Nature*, **421** (6918): 27-28.

Avens, L. & Lohmann, K.J. (2004) Navigation and seasonal migratory orientation in juvenile sea turtles, *Journal of Experimental Biology*, **207** (11): 1771-1778.

Avens L. & Lohmann K.J. (2003) Use of multiple orientation cues by juvenile loggerhead sea turtles *Caretta caretta*, *Journal of Experimental Biology*, **206** (23): 4317-4325.

Boles L.C. & Lohmann K.J. (2003) True navigation and magnetic maps in spiny lobsters, *Nature*, **421** (6918): 60-63.

Branover, G.G., Vasiliev, A.S., Gleiser, S.I. & Tsinober, A.B. (1971) A study of the behaviour of eel in artificial and natural magnetic fields and the analysis of their mechanism of reception (In Russian), *Vop. Ikhtiol.*, **11**: 720-727.

Chew, G.L. & Brown, G.E. (1989) Orientation of rainbow trout (*Salmo gairdneri*) in normal and null magnetic fields, *Canadian Journal of Zoology*, **67** (3): 641-643.

Formicki, K., Sadowski, M., Tanski, A., Korzelecka-Orkisz, A. & Winnicki, A. (2004) Behaviour of trout (*Salmo trutta* L.) larvae and fry in a constant magnetic field, *Journal of Applied Ichthyology*, **20** (4): 290-294.

Haug, C.V. & Walker, M.M. (1998) Magnetic discrimination learning in rainbow trout (*Oncorhynchus mykiss*), *Journal of Navigation*, **51** (1): 35-45.

Hays, G.C., Broderick, A.C., Godley, B.J., Lovell, P., Martin, C., McConnell, B.J. & Richardson, S. (2002) Biphasal long-distance migration in green turtles, *Animal Behaviour*, **64** (895): 898.

Irwin, W.P., Horner, A.J. & Lohmann, K.J. (2004) Magnetic field distortions produced by protective cages around sea turtle nests: unintended consequences for orientation navigation?, *Biological Conservation*, **118** (1): 117-120.

Irwin, W.P. & Lohmann, K.J. (2003) Magnet-induced disorientation in hatchling loggerhead sea turtles, *Journal of Experimental Biology*, **206** (3): 497-501.

Karlsson, L. (1985) Behavioural responses of European silver eels (*Anguilla anguilla*) to the geomagnetic field, *Helgolander Meeresuntersuchungen*, **39** (1): 71-81.

Klinowska, M. (1990) Geomagnetic orientation in cetaceans: behavioural evidence, In *Sensory abilities of cetaceans laboratory and field evidence*, (ed. J.A. Thomas & R. A. Kastelein): 651-663, Plenum Press Corporation, New York.

Kuzhetsov, V.I. (1999) Vegetative responses of dolphin to changes in permanent magnetic field, *Biofizika*, **44** (3): 496-502.

## COWRIE 1.5 Electromagnetic Fields

- Lohmann, K.J. (1991) Magnetic orientation by hatchling loggerhead sea turtles (*Caretta caretta*), *Journal of Experimental Biology*, **155**: 37-49.
- Lohmann, K.J. (1984) Magnetic remanence in the western Atlantic spiny lobster, *Panulirus argus*, *Journal of Experimental Biology*, **113** (Nov): 29-41.
- Lohmann, K.J., Lohmann, C.M., Ehrhart, L.M., Bagley, D.A. & Swing, T. (2004) Geomagnetic map used in sea-turtle navigation, *Nature*, **428** (6986): 909-910.
- Lohmann, K.J. & Lohmann, C.M.F. (1994) Acquisition of magnetic directional preference in hatchling loggerhead sea turtles, *Journal of Experimental Biology*, **190**: 1-8.
- Lohmann, K.J. & Lohmann, C.M.F. (1994) Detection of magnetic inclination angle by sea turtles: a possible mechanism for determining latitude, *Journal of Experimental Biology*, **194**: 23-32.
- Lohmann, K.J. & Lohmann, C.M.F. (1998) Migratory guidance mechanisms in marine turtles, *Journal of Avian Biology*, **29** (4): 585-596.
- Lohmann, K.J. & Lohmann, C.M.F. (1996) Orientation and open-sea navigation in sea turtles, *Journal of Experimental Biology*, **199**: 73-81.
- Lohmann, K.J. & Lohmann, C.M.F. (1998) Sea turtle navigation and the detection of geomagnetic features, *Journal of Navigation*, **51** (1): 10-22.
- Lohmann, K.J., Pentcheff, N.D., Nevitt, G.A., Stetten, G.D., Zimmer-faust, R.K., Jarrard, H.E. & Boles, L.C. (1995) Magnetic orientation of spiny lobsters in the ocean: Experiments with undersea coil systems, *Journal of Experimental Biology*, **198** (10): 2041-2048.
- Lohmann, K.J. & Willows, A.O.D. (1987) Lunar-modulated geomagnetic orientation by a marine mollusc, *Science*, **235**: 331-334.
- Mathis, A. & Moore, F.R. (1988) Geomagnetism and the homeward orientation of the box turtle, *Terrapene carolina*, *Ethology*, **78**: 265-274.
- Metcalf, J.D., Holford, B.H. & Arnold, G.P. (1993) Orientation of plaice (*Pleuronectes platessa*) in the open sea - evidence for the use of external directional clues, *Marine Biology*, **117** (4): 559-566.
- Papi, F., Luschi, P., Akesson, S., Capogrossi, S. & Hays, G.C. (2000) Open-sea migration of magnetically disturbed sea turtles, *Journal of Experimental Biology*, **203** (22): 3435-3443.
- Quinn, T.P. & Groot, C. (1983) Orientation of chum salmon (*Oncorhynchus keta*) after internal and external magnetic field alteration, *Canadian Journal of Fisheries and Aquatic Sciences*, **40** (10): 1598-1606.
- Quinn, T.P., Merrill, R.T. & Brannon, E.L. (1981) Magnetic field detection in sockeye salmon, *Journal of Experimental Zoology*, **217**: 137-142.
- Rommel, S.A. & McCleave, J.D. (1973) Sensitivity of American eels (*Anguilla rostrata*) and Atlantic salmon (*Salmo salar*) to weak electric and magnetic fields, *Journal of Fisheries Research Board of Canada*, **30**: 657-663.

## COWRIE 1.5 Electromagnetic Fields

- Taylor, P.B. (1986) Experimental evidence for geomagnetic orientation in juvenile salmon, *Oncorhynchus tshawytscha*, *Journal of Fish Biology*, **28**: 607-623.
- Tesch, F.W., Wendt, T. & Karlsson, L. (1992) Influence of geomagnetism on the activity and orientation of eel, *Anguilla anguilla*, as evident from laboratory experiment, *The Ecology of Freshwater Fish*, **1**: 52-60.
- Ugolini, A. & Pezzani, A. (1995) Magnetic compass and learning of the Y-axis (sea-land) direction in the marine isopod *Idotea baltica basteri*, *Animal Behaviour*, **50** (2): 295-300.
- Walker, M.M., Kirschvink, J.L., Ahmed, G. & Dizon, A.E. (1992) Evidence that fin whales (*Balaenoptera physalus*) respond to the geomagnetic field during migration, *Journal of Experimental Biology*, **171**: 67-78.
- Westerberg, H. & Begout-Anras, M.L. (1999) Orientation of silver eel (*Anguilla anguilla*) in a disturbed geomagnetic field, In *Third Conference in Fish Telemetry in Europe*, Norwich, UK.
- Willows, A.O.D. (1999) Shoreward orientation involving geomagnetic cues in the nudibranch mollusc *Tritonia diomedea*, *Marine and Freshwater Behaviour and Physiology*, **32** (2-3): 181-192.
- Yano, A., Ogura, M., Sato, A., Sakaki, Y., Shimizu, Y., Baba, N. & Nagasawa, K. (1997) Effect of modified magnetic field on the ocean migration of maturing chum salmon, *Oncorhynchus keta*, *Marine Biology*, **129** (3): 523-530.

**Appendix 6) Natural e-field sources**

Barham, E.G., Huckabay, W.B., Gowdy, R. & Burns, B. (1969) Microvolt Electric Signals from Fishes and the Environment, *Science*, **164**: 965-968.

Bullock, T.H. (1973) Seeing the world through a new sense: electroreception in fish, *Am Science*, **63**: 316-325.

Kalmijn, A.J. (1974) The detection of electric fields from inanimate and animate sources other than electric organs, In *Electroreceptors and other Specialized Receptors in Lower Vertebrates*, (ed. A. Fessard), Springer-Verlag, New York.

Kalmijn, A.J. (1988) Detection of weak electric fields, In, (ed. J. Atema, R. R. Fay, A. N. Popper & W. N. Tavolga): 151-186, Springer-Verlag, New York.

Lilley, F.E.M., Filloux, J.H., Mulhearn, P.J. & Ferguson, I.J. (1993) Magnetic signals from an ocean eddy, *Journal of Geomagnetism and Geoelectricity*, **45** (5): 403-422.

Nomura, K. & Akiyama, I. (1984) New method for measurement of electrocardiograms in unrestrained fish swimming free of electrodes, *Bulletin of the Japanese Society of Scientific Fisheries*, **50** (6): 959-967.

Potts, W.T.W. & Hedges, A.J. (1991) Gill potentials in marine teleosts, *Journal of Comparative Physiology B*, **161** (4): 401-405.

Roberts, M.G., Wright, D.E. & Savage, G.E. (1973) A technique for obtaining the electrocardiogram of fish, *Comparative Biochemistry and Physiology A*, **44** (2): 665-658.

Stephenson, D. & Bryan, K. (1992) Large-scale electric and magnetic fields generated by the oceans, *Journal of Geophysical Research - Oceans*, **97** (C10): 15467-15480.

von der Emde, G. (1998) Electroreception, In *The Physiology of Fishes*, (ed. D.H. Evans): 313-343, CRC Press.

**Appendix 7** Consultation Request sent to Offshore Wind Farm Developers

Date: 19 November 2004

Our Ref: J3031

Your Ref:

<<ADDRESS>>

Dear Developer

**RE: COWRIE ELECTROMAGNETIC FIELD STUDY**

<<SITE>>

Centre for Marine and Coastal Studies Ltd (CMACS), together with Cranfield University, has been commissioned by COWRIE to undertake a review of information relating to the ecological significance of electromagnetic fields generated by sub sea power cables associated with offshore wind farm developments. This desk-based project will inform the next major phase of work.

I understand that Dr Carolyn Heaps from the Crown Estate has been in contact with you recently to explain that CMACS might request information to support the study. We are looking to collate as much information as possible on fish in wind farm development areas so that we can identify potential sensitivities to electric and magnetic fields. We also wish to provide a comprehensive overview of actual/planned cabling arrangements and to develop suggestions for appropriate environmental monitoring.

We are therefore requesting the following:

- copies of scoping reports, environmental statements and, in particular, supporting studies (i.e. technical reports and data) by consultants on fish, fisheries and/or significance of electromagnetic fields;
- cabling specifications: maximum voltages and currents, including phase information; cable dimensions and total length of cabling; cable materials and properties (conductivity, dielectrical constant and permeability); burial depth and cable layout (including separation distances of cables to shore);
- details of any specific technical information on electromagnetic fields, including predicted magnetic and induced electric field strengths;
- details of any monitoring requirements relating to either fish or electromagnetic fields (e.g. FEPA conditions, if relevant) and your current or anticipated approach to that monitoring.



## COWRIE 1.5 Electromagnetic Fields

Our timeframe for this project is tight, we need to report by the end of January. I would therefore be most grateful if you could provide information that you might have by 17 December.

Please feel free to contact me directly, or to request appropriate persons from your organisation or your consultants to do so. We will be grateful to receive reports etc. electronically on CD or by email or in hard copy otherwise.

Yours sincerely

Dr Ian Gloyne-Phillips  
Director

[ian@cmacsltd.co.uk](mailto:ian@cmacsltd.co.uk)

**Appendix 8.** KIS-CA cable awareness charts.

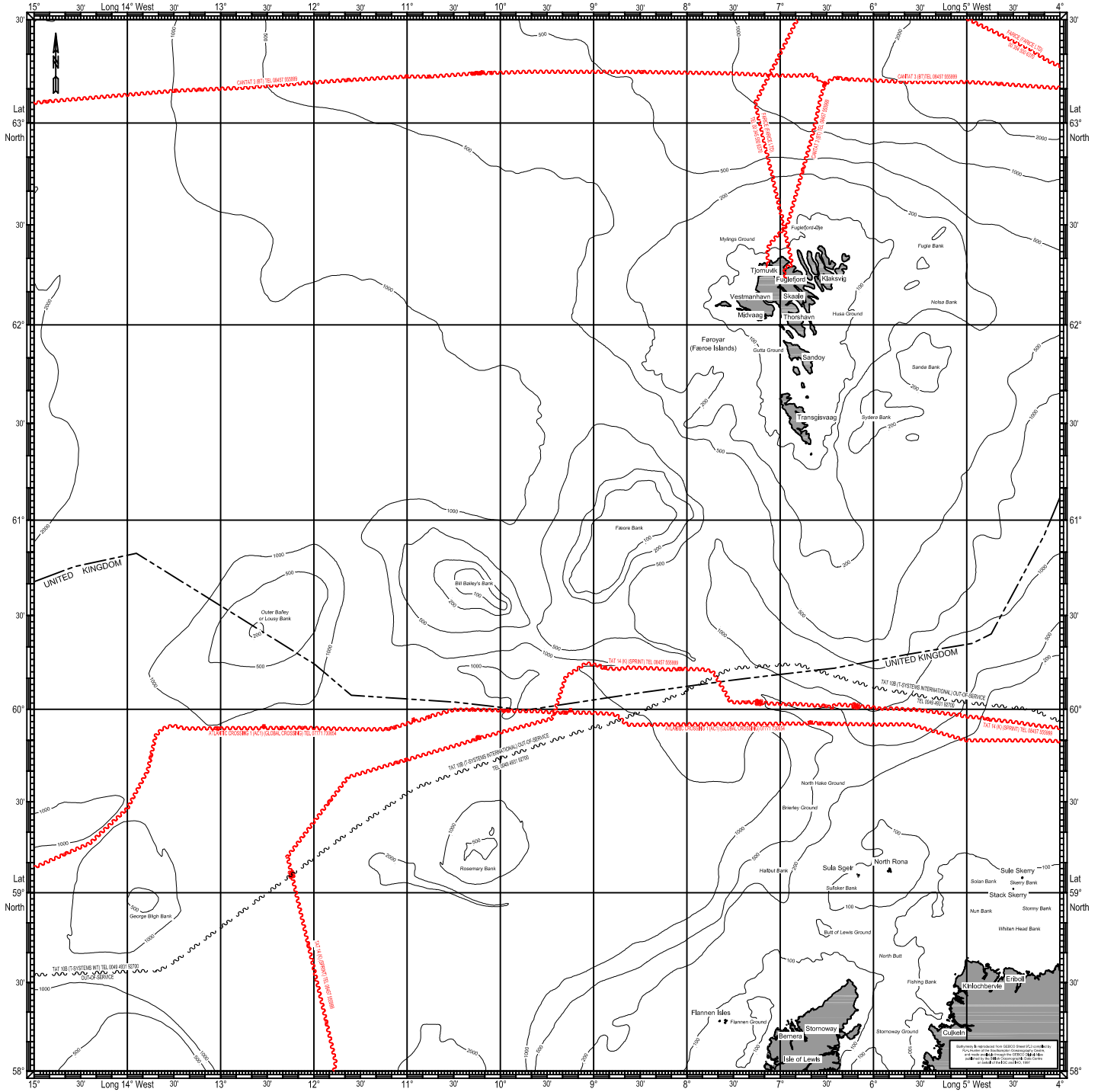

NOT TO BE USED FOR NAVIGATION

Scale 1:1,400,000

PLEASE KEEP CLEAR OF AND DO NOT DAMAGE SUBMARINE TELEPHONE CABLES

THESE CABLES CARRY HIGH VOLTAGE AND CAN BE DANGEROUS TO LIFE

YOU RISK LOSS OF GEAR AND

**KINGFISHER  
CABLE AWARENESS CHART  
IRISH SEA**

- In Use Submarine Telecommunications Cable
- Out of Service Submarine Telecommunications Cable
- Proposed Submarine Telecommunications Cable
- In Use Submarine Telecoms/Power Cable
- Repeater (RP) or Branch Unit (BU)
- Initial Splice (IS) or Final Splice (FS)
- Pipeline Crossing (PK)

WGS 84 Spheroid - Satellite Datum  
 WOULD SKIPPERS PLEASE PLOT COORDINATES INTO  
 THEIR FILING PLOTTERS OR ELECTRONIC CHARTS  
 COORDINATE COMPATIBLE WITH GPS SYSTEMS

**CONTACT NUMBERS**

CYC HIBERNA ATLANTIC	07771 730654
BT	08437 559989 / 01223 390120
CABLE & WIRELESS	020 7 528 2058
ESAT	08437 559989 / 01223 390120
GLOBAL CROSSING	07771 730654
IRISH ELECTRICITY COMPANY	08437 559989 / 01223 390120
N. IRELAND ELECTRICITY	028 99 857864
NTL	01483 875200

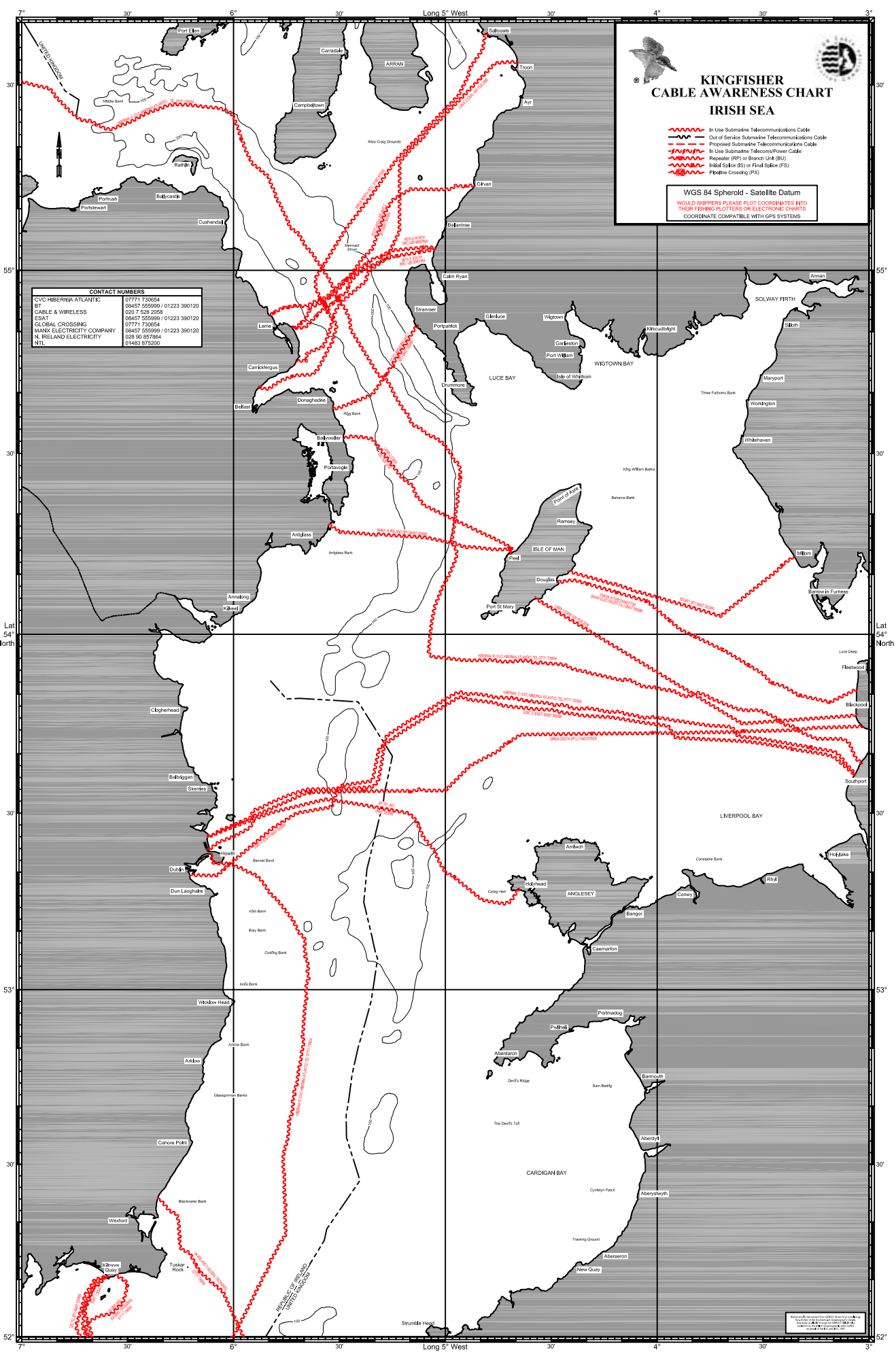

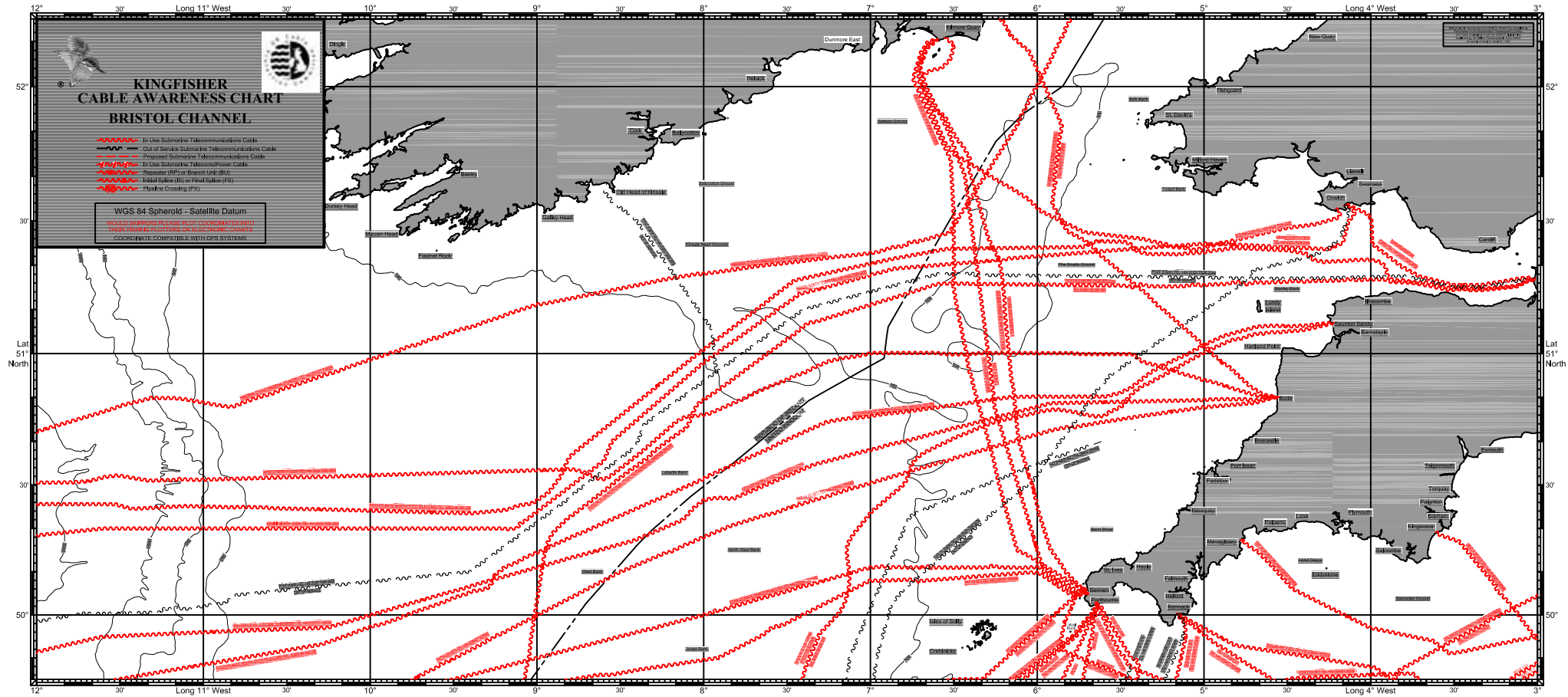

NOT TO BE USED FOR NAVIGATION

Scale 1:825,000

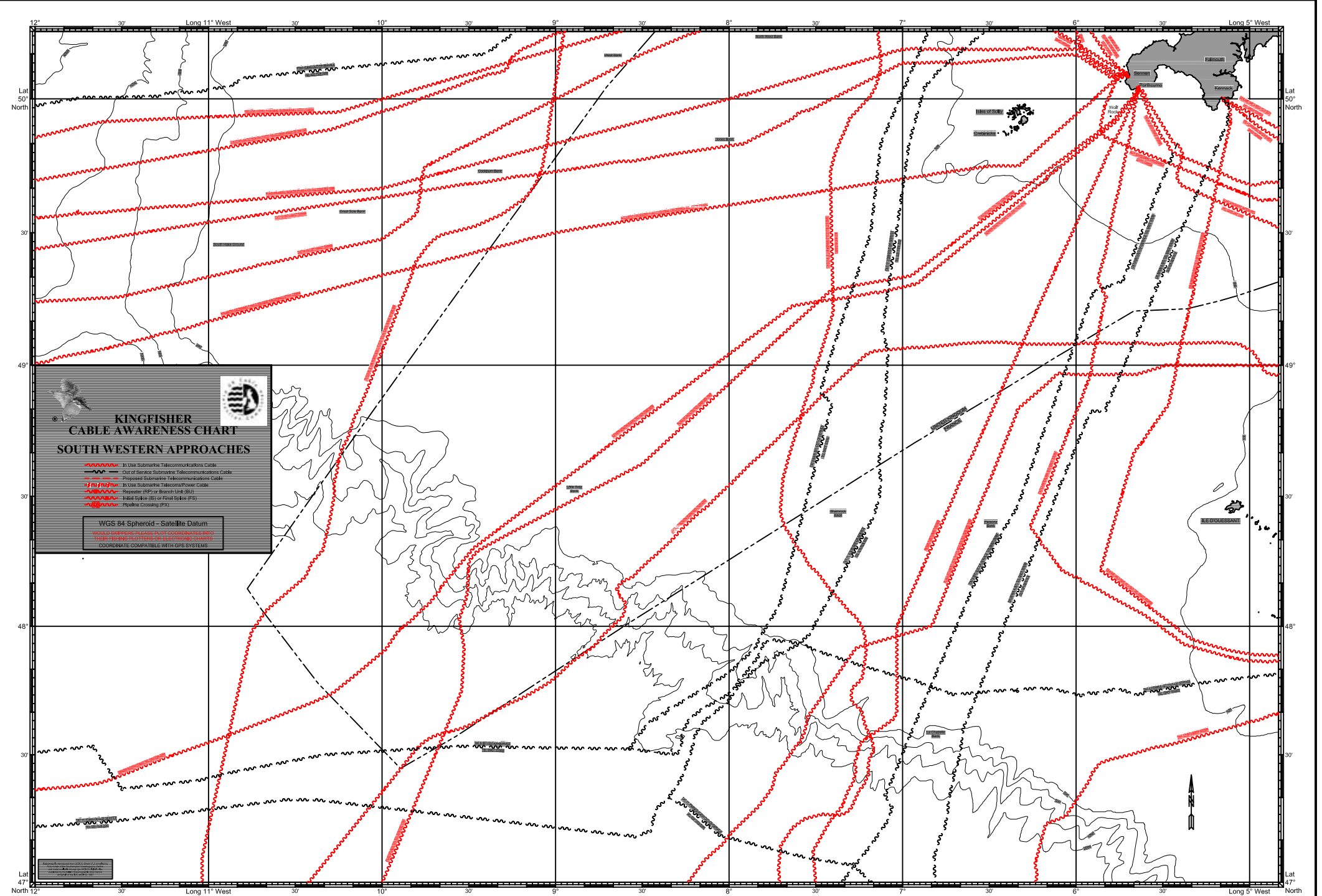

**KINGFISHER  
CABLE AWARENESS CHART  
SOUTH WESTERN APPROACHES**

- In Use Submarine Telecommunications Cable
- Out of Service Submarine Telecommunications Cable
- Proposed Submarine Telecommunications Cable
- In Use Submarine Telecoms/Power Cable
- Repairer (R) or Branch Link (BL)
- Initial Sinker (IS) or Final Sinker (FS)
- Pipeline Crossing (PC)

WGS 84 Spheroid - Satellite Datum  
 World coordinates are given in WGS 84 datum  
 WGS 84 datum is compatible with GPS systems  
 COORDINATE COMPATIBLE WITH GPS SYSTEMS

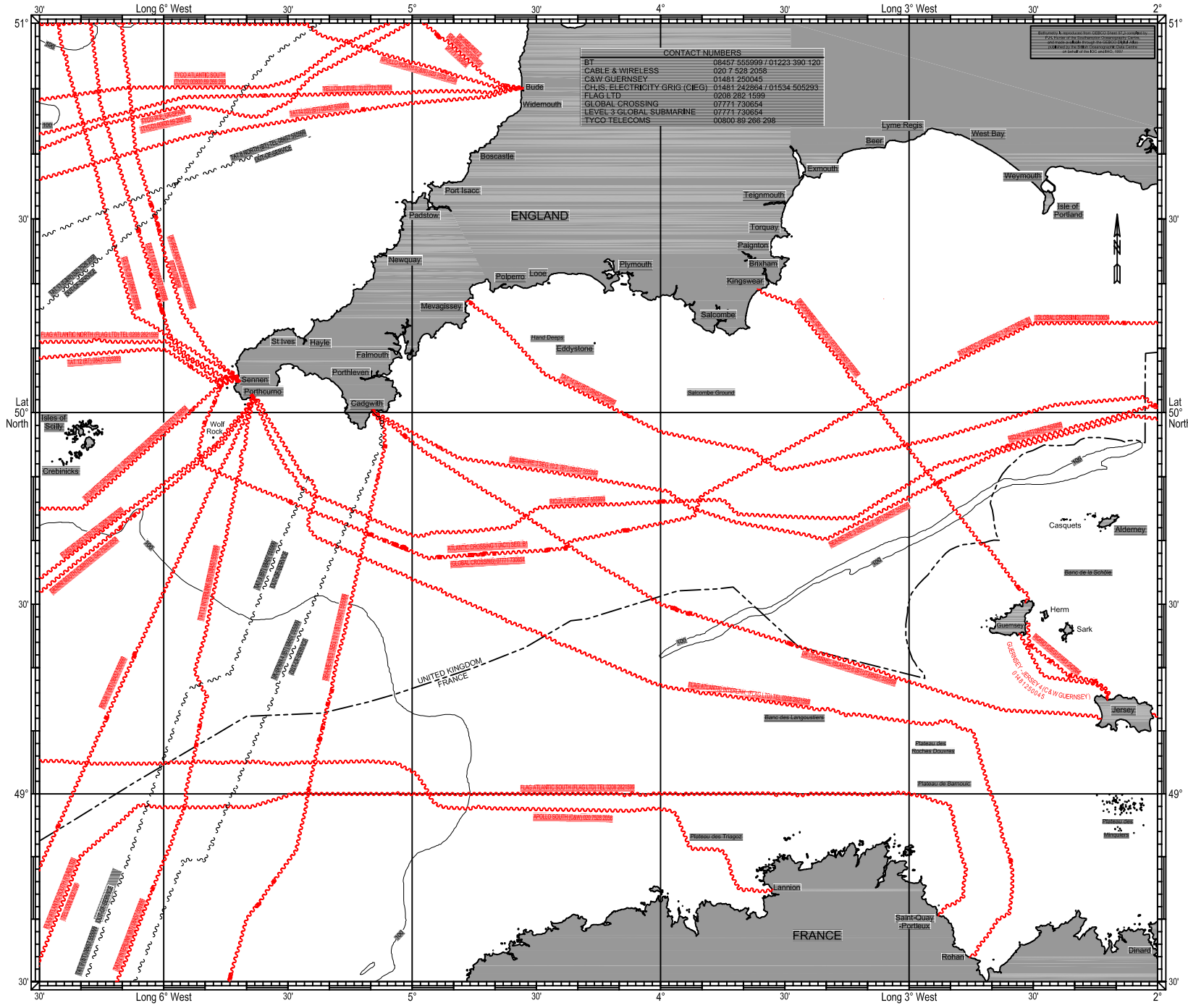

**CONTACT NUMBERS**

BT	08457 555999 / 01223 390 120
CABLE & WIRELESS	020 7 528 2058
C&W GUERNSEY	01481 250045
CH.I.S. ELECTRICITY GRID (CIEG)	01481 242864 / 01534 505293
FLAG LTD	0208 282 1599
GLOBAL CROSSING	07771 730654
LEVEL 3 GLOBAL SUBMARINE	07771 730654
TYCO TELECOMS	00800 89 266 298

NOT TO BE USED FOR NAVIGATION

Scale 1:800,000



# CABLE AWARENESS CHART

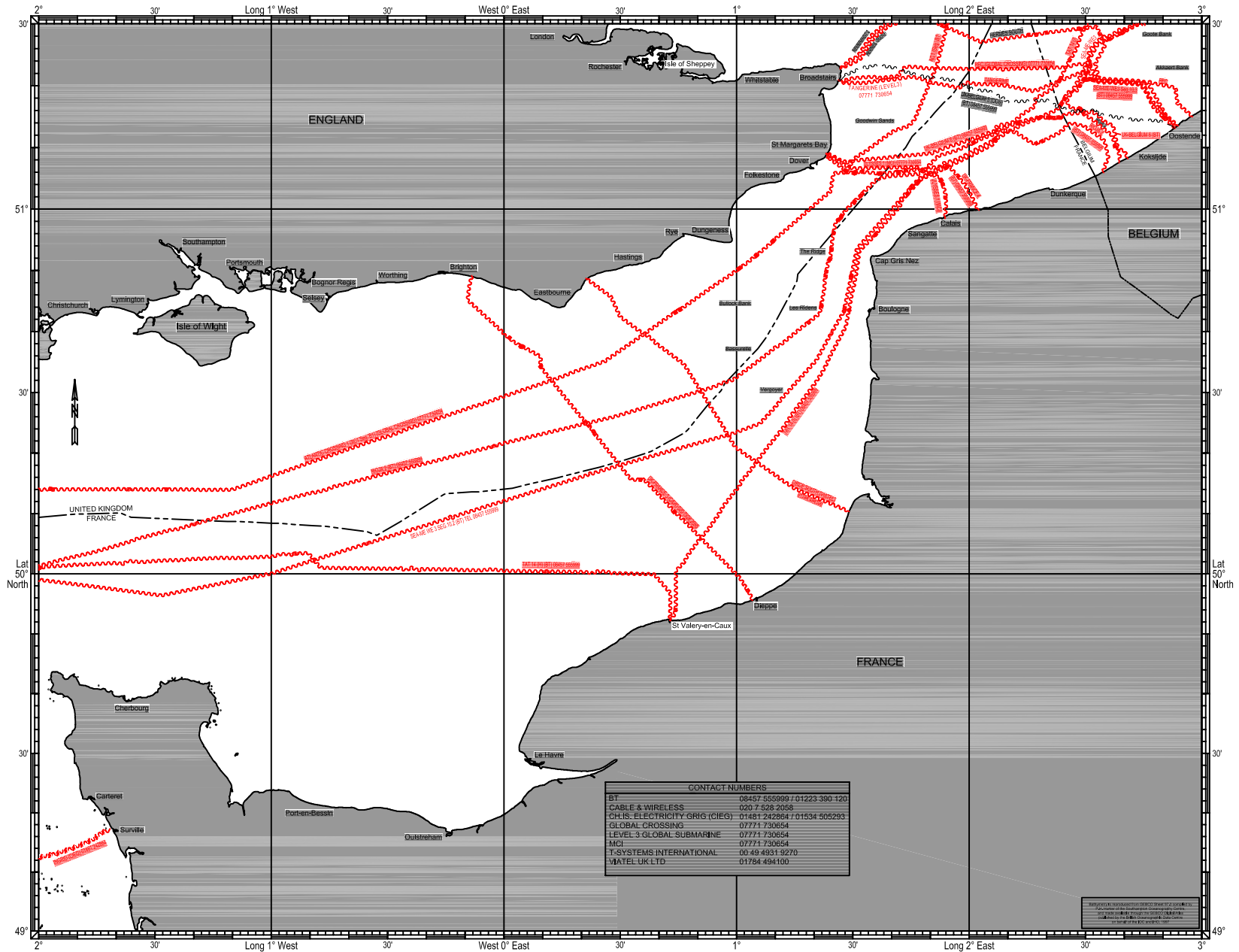



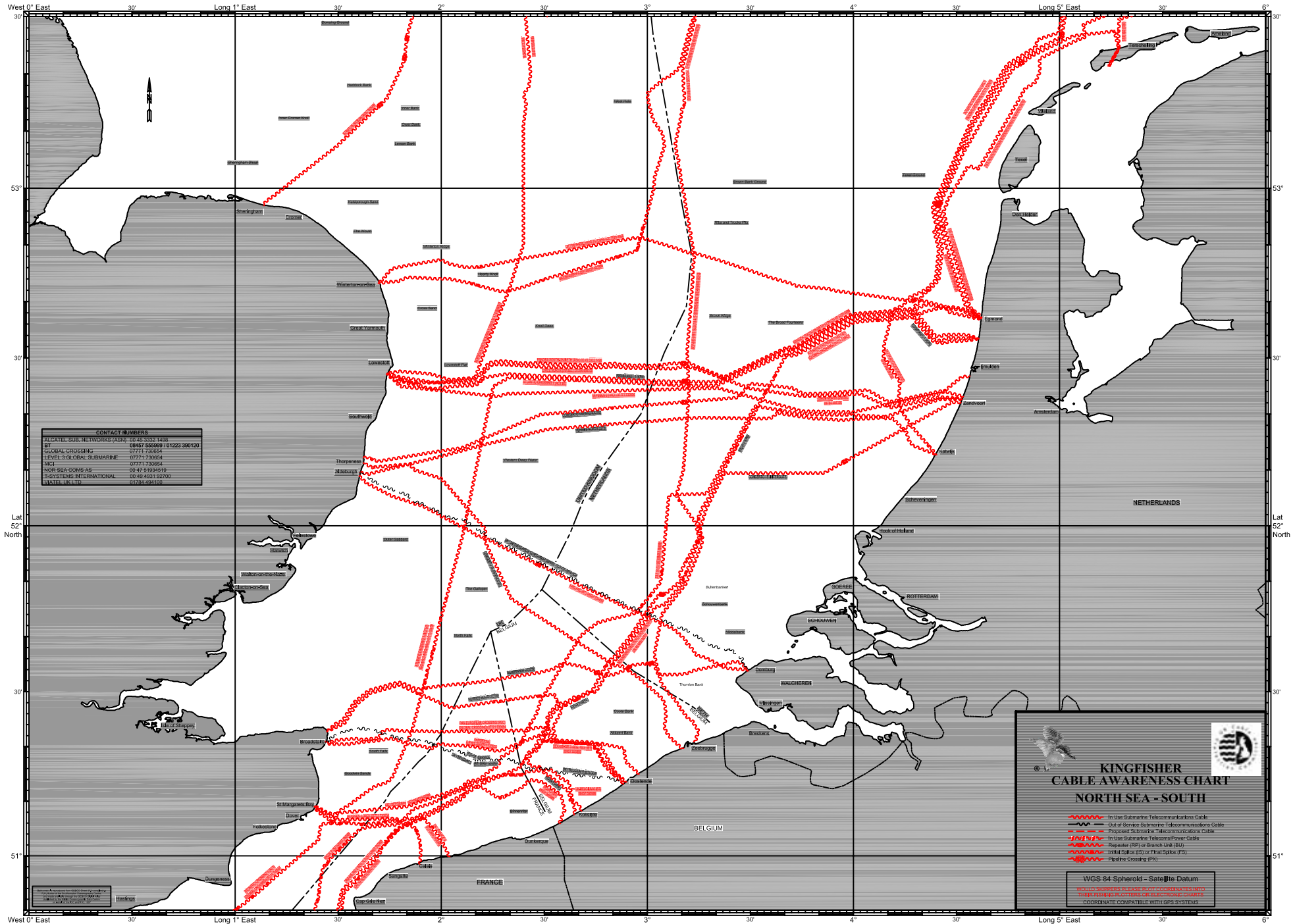

**CONTACT NUMBERS**

ALCATEL-SUB-NETWORKS (ASN)	00 45 333 1188
BT	0047 555699 / 01223 390120
GLOBAL CROSSING	0771 730854
LEVEL GLOBAL-SUBMARINE	0771 730654
AMCI	0771 730854
WORK SEA COMS AS	00 47 21034519
TELECOMS INTERNATIONAL	00 45 4331 22700
WATTEL UK LTD	01783 494100

**KINGFISHER  
CABLE AWARENESS CHART  
NORTH SEA - SOUTH**

- In Use Submarine Telecommunications Cable
- Out of Service Submarine Telecommunications Cable
- Proposed Submarine Telecommunications Cable
- In Use Submarine Telecommunications Power Cable
- Proposed SPS or Branch Line (BL)
- Initial Splice (IS) or Final Splice (FS)
- Pipeline Crossing (PC)

WGS 84 Spheroid - Satellite Datum

WORLD AWARENESS CHARTS IS COORDINATED WITH  
WORLD WIDE POSITIONING SERVICES (WPPS) SERVICE  
COORDINATE COMPATIBLE WITH GPS SYSTEMS

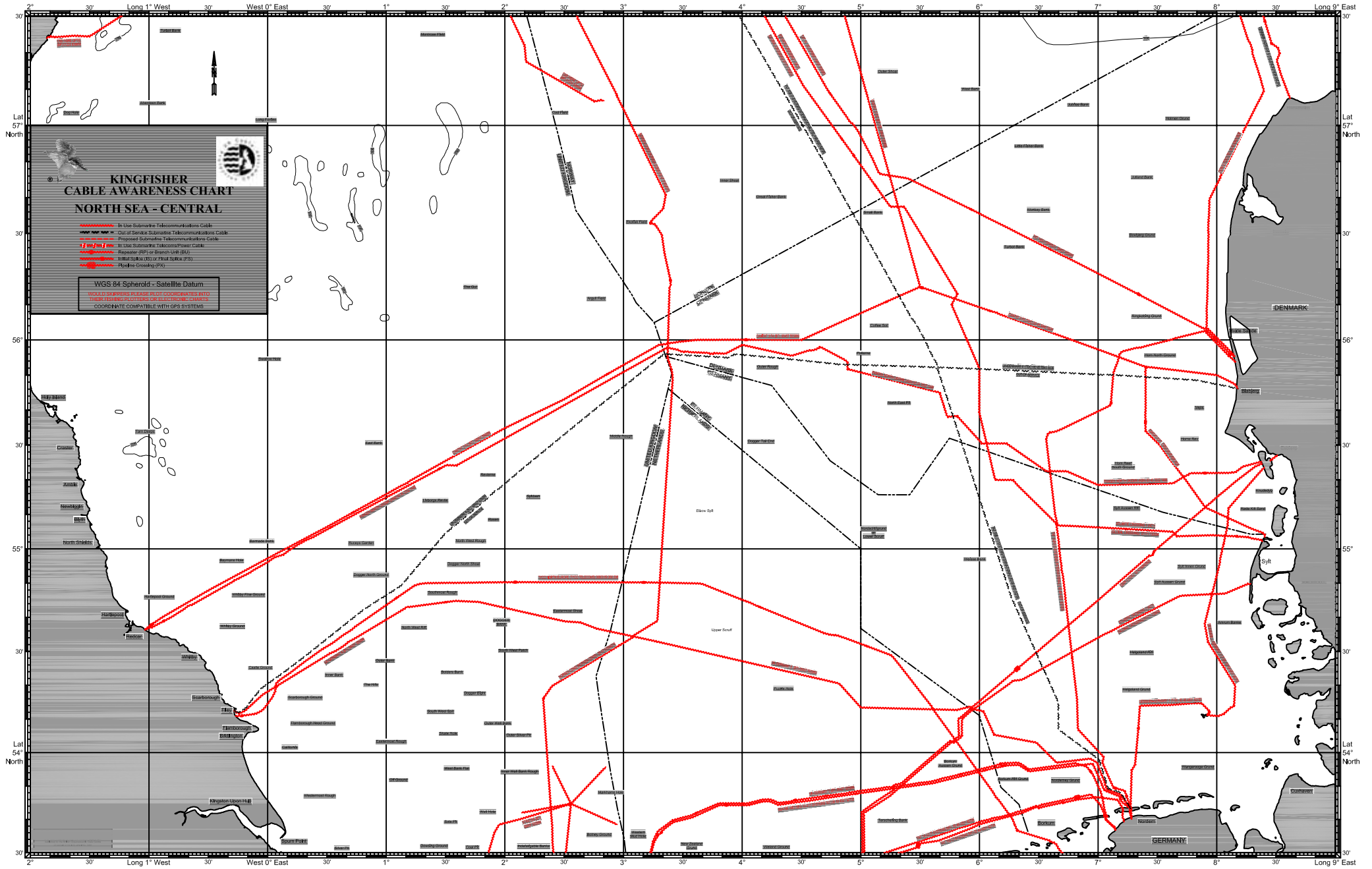

**KINGFISHER  
CABLE AWARENESS CHART  
NORTH SEA - CENTRAL**

- - - - - In Use Submarine Telecommunications Cable  
 - - - - - Out of Service Submarine Telecommunications Cable  
 - - - - - Proposed Submarine Telecommunications Cable  
 - - - - - In Use Submarine Telecommunications Power Cable  
 - - - - - Repeater (RP) or Branch Unit (BU)  
 - - - - - Initial Splice (IS) or First Splice (FS)  
 - - - - - Power Cables (PC)

WGS 84 Spheroid - Satellite Datum  
 WOULD BE BETTER PLEASE PLOT COORDINATES INTO  
 YOUR INSTRUMENTS OR ELECTRONIC CHARTS  
 COORDINATE COMPATIBLE WITH GPS SYSTEMS

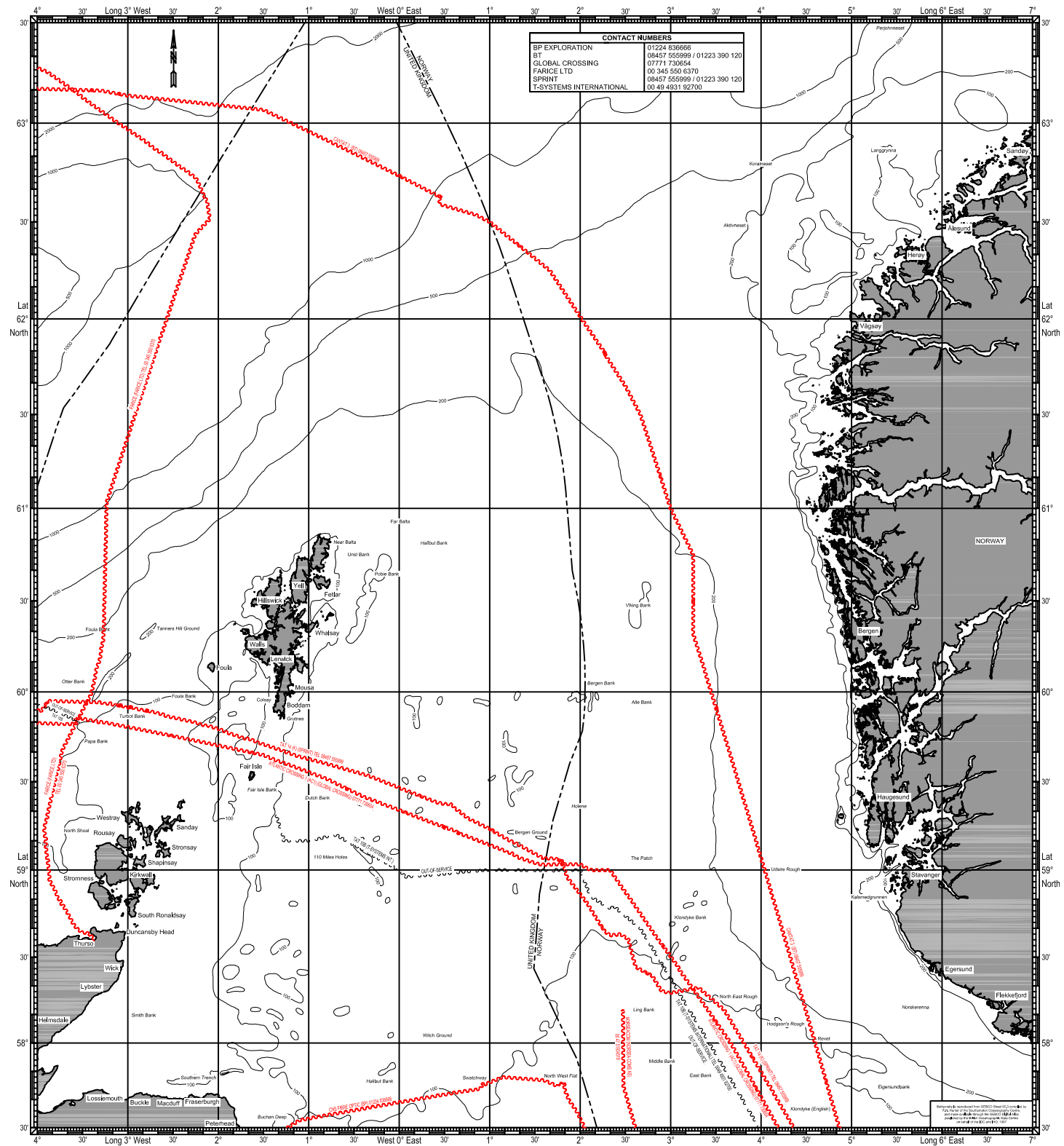

NOT TO BE USED FOR NAVIGATION

Scale 1:1,400,000

PLEASE KEEP CLEAR OF AND DO NOT DAMAGE SUBMARINE TELEPHONE CABLES

THESE CABLES CARRY HIGH VOLTAGE AND CAN BE DANGEROUS TO LIFE

YOU RISK LOSS OF GEAR AND

## Appendix 9. CEFAS Fisheries data for ray species

<http://www.cefasc.co.uk/fishinfo/Western%20Stocks/Ray%20plots.htm>

Total catch numbers of selected species caught in the Westerly Beam Trawl Surveys of CEFAS. The stations in VIIa, f, g and d are fished on the RV CORYSTES, one of CEFASs' research vessels, fishing one, 4m beam trawl with a 20 mm cod-end liner. The stations in VIIe are fished on FV CARHELMAR, a beam trawler chartered out of Plymouth, fishing two 4m beam trawls with a 20 mm cod-end liner in each trawl. All tows are 30 minutes in duration, towed at approximately 4 knots. The numbers of stations per rectangle in the Irish Sea has varied from year to year but has been consistent since 1996. The first diagram labelled fishing positions gives you the ICES rectangle mid points where fishing took place in this rectangle.

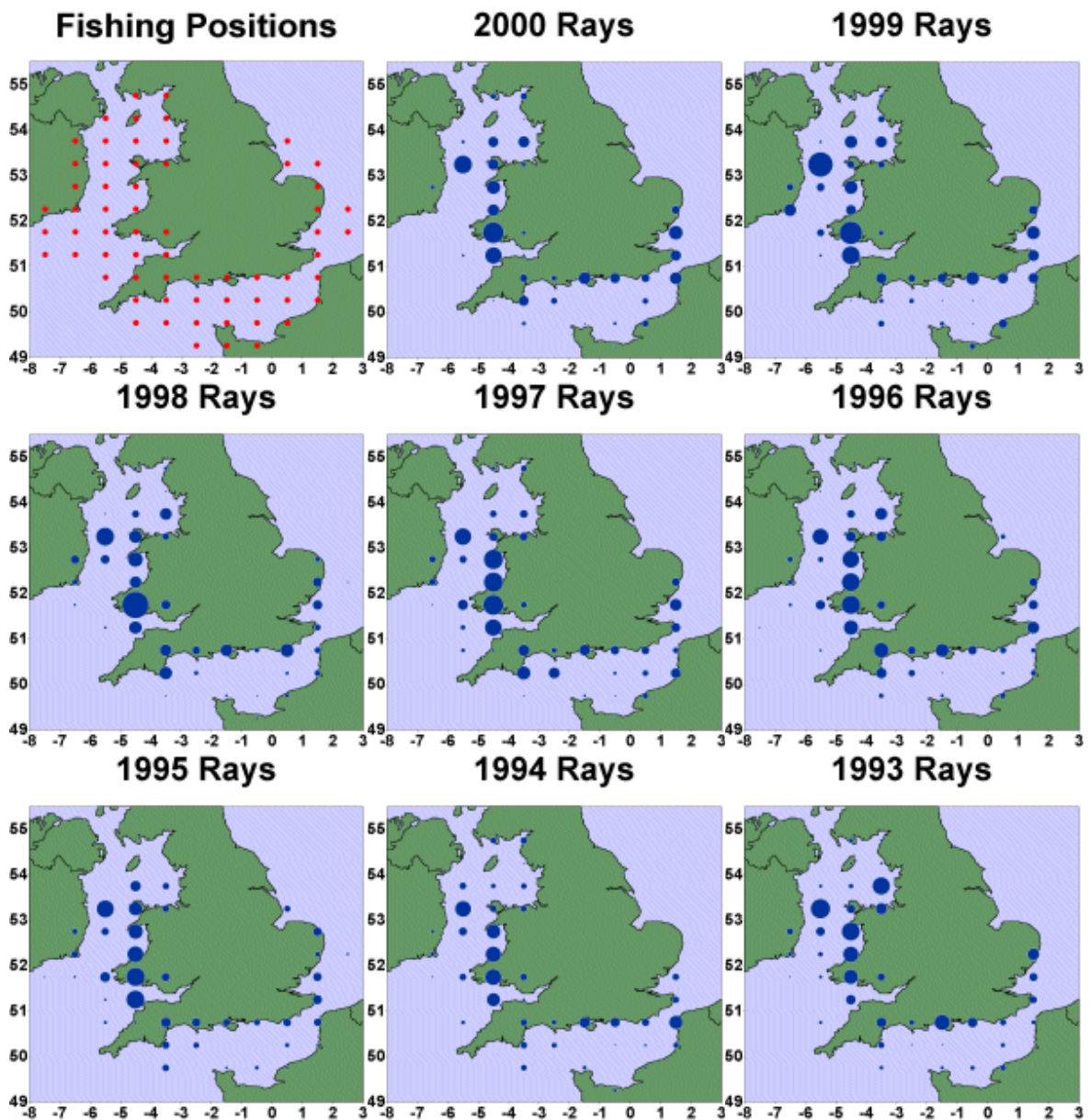



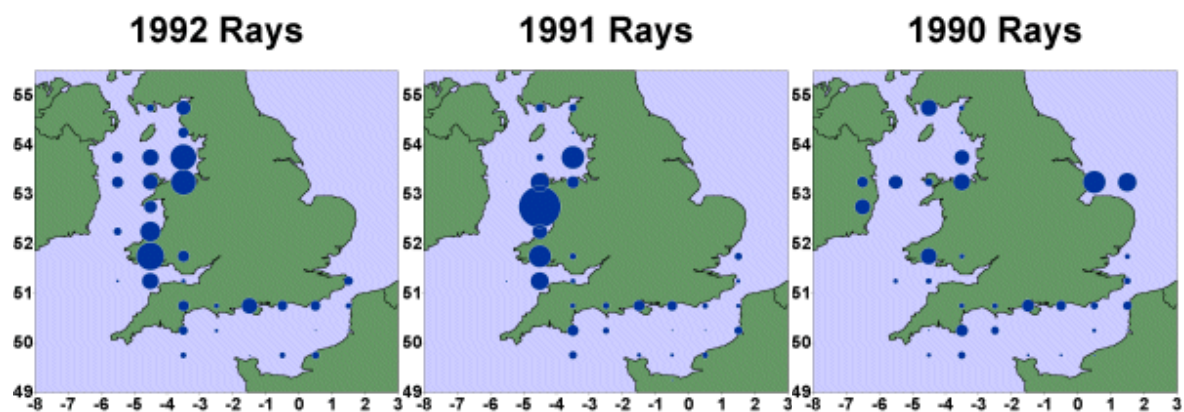

Last modified: January 5, 2005  
[© Crown Copyright 2005](#)

**Appendix 10.** Report by EConnect Ltd.



## An Update on UK Offshore Wind Farm Design Strategy

**Econnect Project No: 1356**

<b>Prepared For</b>	Dr Ian Gloyne-Phillips Coastal Technical Director CMACS Ltd The Cammell Lairds Waterfront Park Campbeltown Road Birkenhead Merseyside CH41 9HP
---------------------	--

	<b>Name</b>	<b>Date</b>	<b>Signature</b>
<b>Prepared By</b>	Adel Jawad	21/01/2005	
<b>Checked By</b>	Morgan Donnelly	21/01/2005	
<b>Approved By</b>	Jonathan Hill	21/01/2005	

<b>Document History</b>		
<b>Issue No</b>	<b>Description</b>	<b>Date</b>
01	Original Document Issue	21/01/2005

<b>Copy No.</b>	<b>Copy Issued To</b>	<b>Company</b>
1	Dr Ian Gloyne-Phillips	CMACS Ltd
2	Econnect (Client File)	Econnect Ltd
3	Econnect (Project File)	Econnect Ltd



## Table of Contents

1	Introduction .....	4
2	Technology Overview .....	4
2.1	Turbine Power Output .....	4
2.2	Alternating Current (AC) designs.....	4
2.3	Direct Current (DC) Designs.....	5
2.4	The Electrical System within the Offshore Wind Farm Array.....	5
2.5	AC Array to Shore Connection .....	6
2.5.1	AC Cables.....	6
2.6	Transmission Voltage Selection .....	6
2.6.1	Limitation on AC Transmission Circuits .....	7
2.7	DC Array to Shore Connection .....	8
2.7.1	DC Cables .....	8
2.7.2	Operation Mode of the DC Connection.....	8
2.8	AC Connections vs. DC Connections.....	8
3	Comments .....	9

## 1 Introduction

There are a number of offshore wind farm projects in the UK, at various stages of development, construction and operation.

The North Hoyle and Scroby Sands wind farms with generation capacity of 60MW and 82MW respectively are the two largest offshore wind farm projects currently in operation, which were granted licences by The Crown Estate as part of Round One for major wind farm projects around the British coastline.

Offshore wind farms with capacities ranging from 64MW to 1200MW have recently been granted licences by the Crown Estate during Round Two for major wind farm projects around the British coastline. These Round Two wind farms are grouped into three broad geographical areas, the Thames Estuary, the Greater Wash, and an area off the coast of North West England.

Econnect Ltd has been commissioned by CMACS to provide an update on UK offshore wind farm cabling system design strategies. Econnect's original report<sup>1</sup> was submitted to the ERC in April 2003 as part of a study on electro-magnetic fields around sub-sea cables.

This report reviews the options and requirements for offshore wind farm electrical systems associated with larger offshore wind farms and also reviews the emergent design technologies that are likely to be available within the timescales of the Round Two offshore wind farm developments.

## 2 Technology Overview

The following section describes the main technologies that may be utilised in connecting large offshore wind farm projects to the existing onshore electrical grid infrastructure.

### 2.1 Turbine Power Output

Due to the proportionally high cost of the turbine foundations and other offshore facilities associated with offshore wind farms, and with many fixed costs to be taken into account, it is quite likely that the Round Two wind farm developers may opt for the largest wind turbines possible. Currently the largest wind turbines in development have a proposed power output of 5MW.

### 2.2 Alternating Current (AC) designs

The existing large offshore wind farms are connected to shore at the voltage used within the wind farms collection cabling. The proposed larger offshore wind farms of Round Two are likely to be connected to existing on-land electrical grid infrastructure at 132kV or above and consequently the offshore wind farms shore link cabling will probably run at 132kV. However, it is unlikely to be practicable to use voltages higher than 33kV at wind turbine locations.

The following describes the key features that will form the basis of all design options using HVAC power as the offshore wind farm array to shore transmission medium:

- The point of connection (POC) will be with either the local distribution network or transmission network;
- Land route cables (single core) running from the POC to the shoreline jointing chamber;

---

<sup>1</sup> UK Offshore Windfarm Cabling Strategies – Part of an investigation of EMF generated by subsea windfarm power cables. Issue No.1, Dated 08/04/03. File Ref: rad 0963 erc rep 01 windfarm cabling strategies.doc

- Three-core Subsea cable(s) running from the shoreline jointing chamber to an offshore platform-mounted substation(s) within the windfarms;
- The Offshore platform mounted substation(s) will incorporate switchgear, transformers etc to convert the voltage of the wind turbine collection array cabling to the array to shore subsea cable(s) voltage, as well as switchgear to control the wind turbine collection array cabling circuits that interconnect the individual wind turbines;
- Array collection cabling from the offshore substation platform(s) interconnecting each wind turbine;
- Wind turbines, complete with generator, control and protection systems, with links to an overall supervisory control and data acquisition (SCADA) system;

Note: larger capacity wind farms will probably included several satellite substation platforms, each of which will operate as a collection point for a group of wind turbines.

### 2.3 Direct Current (DC) Designs

HVDC array to shore transmission schemes will incorporate HVAC to HVDC, and HVDC to HVAC Converter Stations at either end of the array to shore cable(s).

The key features that form the basis of all design options using HVDC as the array to shore transmission medium are as follows:

- The point of supply (POS) will be with either the local distribution network or transmission network;
- HVDC onshore converter station located adjacent to the POS.
- Land route DC cable running from the HVDC converter station to the shoreline jointing chamber;
- Subsea DC cable running from the shoreline jointing chamber to an offshore platform-mounted HVDC/HVAC converter station;
- Offshore platform-mounted HVDC converter station with satellite AC platforms, (connected at either 132kV or 245kV), supporting the transformers and switchgear that collect the power from the wind farm array cabling running at 33kV.
- Wind turbines, complete with generator, control and protection systems, with links to an overall supervisory control and data acquisition (SCADA) system;

Note: layer wind farms will probably included several satellite substation platforms to convert to groups of wind turbines.

### 2.4 The Electrical System within the Offshore Wind Farm Array

It is useful to treat the electrical system within the offshore wind farm array separately from the electrical system connection to the shore. Currently the highest AC voltage used to interconnect land based wind turbines is 33kV. It appears likely that this will also be the highest AC voltage used to interconnect offshore wind turbines. This is because the physical dimensions of switchgear and transformer equipment increases considerable for voltages above 33kV.

Therefore, the key features, which will be common for all the Round Two offshore wind farms, are:

- Each offshore wind turbine will contain its own transformer and 33kV switchgear. The transformer will match the turbine generator voltage with the array collection voltage. The switchgear will combine electrical protection functions with an ability to reconfigure the offshore inter-turbine array collection system.

- The array collection cable voltage will be 33kV, as this has proven to be the maximum practical voltage for this application when considering the power levels to be transferred, the space constraints, and the cost and the functionality of the available switchgear.

## **2.5 AC Array to Shore Connection**

### **2.5.1 AC Cables**

Cables insulated with XLPE (Cross-Linked Polyethylene) are by far the most dominant type of cable used for new AC electrical systems.

For the majority of the Round Two wind farms, array to shore connections using 3-core 132kV XLPE insulated subsea cable maybe the preferred option. This cable has a 200MW power capacity, a diameter of approximately 200mm, and weighs approximately 72 tonnes per km. Further details are shown in Figure 1 below.

A higher power transfer per cable could be achieved by using 3-core 245kV subsea cable, however this type of cable is currently under development. The core insulation thickness for a 245kV subsea cable is anticipated to be approximately 250mm and consequently will be heavier than the 3-core 132kV XLPE insulated subsea cables described above.

Three-core cables are utilised for the long HVAC offshore runs, as this allows all three phases to be laid in one operation, rather than the ploughing of three separate trenches required should single core be used. Also the close proximity of the three phases within a 3-core cable minimise the magnetic field leakage, and also minimise the circulating currents that can flow in the wire armour of the cable sheath. With standard single core cables the cable sheath currents can create additional losses to the order of two thirds of the typical load losses.

The cables used for connecting the offshore subsea cables to the POC are usually run as three single core cables. This is because these land based cable runs are typically short by comparison to the offshore subsea cable runs, and it is possible to configure the earthing arrangements of the sheaths to limit circulating currents to acceptable levels. A large pit is constructed close to the sea landing, above high water mark, for jointing the land-based cables and the offshore subsea cable(s); this pit is referred to as the shoreline-jointing chamber.

## **2.6 Transmission Voltage Selection**

The voltages that could be selected for the HVAC shorelink transmission circuits are 132kV and 245kV. The selection is limited by the current maximum voltage rating for 3-core subsea cable. 132kV is a standard voltage used in the UK electricity supply industry, and as a result, transformer designs and switchgear equipment is readily available at this voltage. For some projects, the onshore point of connection is an existing 132kV substation or 132kV section of existing electrical infrastructure, which avoids the need for a further transformation. Systems operated at voltages intermediate between 132kV and 275kV will require additional transformation at the POC.

Submarine Composite Cable - Typical cross sectional area

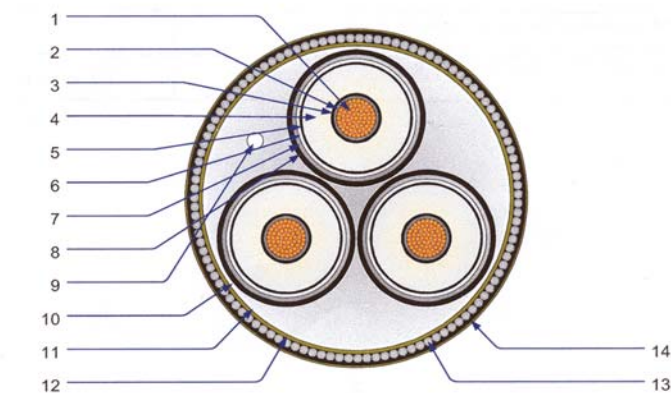

(diagrammatic only – not to scale)

Layer description

1. Conductor	8. Anti-corrosion sheath
2. Binder tape	9. Optical unit
3. Conductor screen	10. Fillers
4. Insulation	11. Binder tape
5. Insulation screen	12. Armour bedding
6. Water barrier	13. Armour (galvanised steel wires)
7. Metallic sheath	14. Serving

Overall cable sizes (approx.):

- conductor cross section	(mm <sup>2</sup> )	3x760
- diameter	(mm)	201
- weight in air	(kg/m)	72.1
- weight in sea water	(kg/m)	53.7

Figure 1. Typical 132kV 3-core subsea cables for AC transmission (Courtesy of Pirelli)

## 2.6.1 Limitation on AC Transmission Circuits

Efficient power transfer using HVAC is limited by the cable charging current induced in the cable due to the capacitance between each phase conductor and earth. This charging current reduces the power carrying capability in the AC cables and is a function of length, effectively limiting the viable length of offshore subsea AC cable connections. However the addition of reactive compensation at both ends of the cable can mitigate this power transfer limitation.

## 2.7 DC Array to Shore Connection

### 2.7.1 DC Cables

With DC transmission, a charging current only occurs during the instant of circuit switching and therefore has no effect on the continuous current rating (and hence power transfer capability) of the electrical system. Consequently the cable length constraints and voltage level limitations associated with AC transmission cables are eliminated. This explains why DC transmission systems have been installed for long cable interconnections (including submarine crossings such as the France-England, and Scotland-Northern Ireland (Moyle) interconnectors, the UK Norway link, the Western Isles link and the Bass link (between Australia and Tasmania)<sup>2</sup>).

The costs for DC transmission cables are lower than for AC transmission cables partially due to the lack of charging current and their consequent ability to transfer larger amounts of power per cable core, thus requiring fewer cable cores for a given power transfer. However overall cost savings are only achieved by HVDC where there are long transmission distances due to the fixed cost of the converter stations at either end.

500MW can be transferred with a Bipole HVDC transmission scheme at  $\pm 150\text{kV}$  using cables with  $2,000\text{mm}^2$  copper conductors. This results in single core cables of  $\sim 112\text{mm}$  diameter, weighing  $\sim 42$  tonnes per km.

### 2.7.2 Operation Mode of the DC Connection

HVDC interconnectors may be built as either monopolar or bipolar systems.

- a monopolar (monopole) system has a single, high-voltage DC conductor with the return conductor included within the same cable and operating at earth potential. A single set of AC/DC converters (one converter pole) is required at each end of the DC cable. Operational reliability of a monopole link is considerably less than a bipole since a failure of a monopole link or maintenance to any item of monopole equipment will require shutdown of the DC transmission system.
- a bipolar (bipole) system transmits power through two high-voltage DC conductors of opposite polarity with two sets of AC/DC converters (two converter poles) at each end. The individual DC power cables are rated at half the total power rating of the DC transmission system. This configuration is typically used if the required transmission capacity for the DC connection exceeds that of a single pole converter.

## 2.8 AC Connections vs. DC Connections

The offshore wind farms contained within the Round Two tranche differ significantly from any previous wind farms constructed in or around the coastline of the UK because of the higher generation export capacities and because of the distances over which the power must be transmitted in order to connect into the UK electrical grid infrastructure network.

DC transmission offers lower cable cost and higher power transfer capabilities (per cable) compared to AC transmission, and does not have its capacity reduced by charging currents as the offshore wind farm array to shore cable length increases. AC transmission on the other hand does not have the additional costs of the converter stations required at either end of DC transmission systems. The case for a DC connection improves therefore as power transfer requirements and transfer distance increase.

Whilst it is difficult to be precise about the break points between the choice of AC or DC, it is generally accepted that for distances up to a few tens of kilometres, and power levels of some hundred megawatts, AC cable connections will be preferable. Above these levels, DC connections become more competitive. To determine the most appropriate offshore wind farm array to shore transmission system, it is recommended that lifetime cost analysis is performed for both HVAC and HVDC when the transmission distance exceeds 60km and the power transfer requirements are greater than 300MW.

### **3 Comments**

For many of the Round Two wind farms, connection using an AC transmission system with 3-core 132kV subsea cable(s) may be the most cost effective solution, despite the extra number of cables and offshore array collection platforms associated with these solutions.

The 3-core 245kV subsea cable, currently under development, could be employed to maximise the power transfer capacity of AC shorelink transmission systems.

The use of HVDC shorelink transmission only becomes cost effective where a project is a significant distance from the coastline and where large amounts of power need to be transferred. This is due to the high costs of the HVDC converter stations, as well as the costs associated with providing a suitable platform on which to site the offshore HVDC converter.

## Appendix 11.

### Questions regarding the report COWRIE-EMF-01-2002 “A Baseline study of electromagnetic fields generated by offshore windfarm cables.

- 1) On page 9 reference is made to the so called “AC conduction field solver model”. Given a certain geometry this model computes the scalar electric potential  $\phi$ , from which the vectorial electric field  $\mathbf{E}$  strength is calculated by using the expression  $\mathbf{E} = -\text{grad } \phi = -\nabla\phi$ . Using the well-known vector relationship  $\text{rot grad } \phi = \nabla \times \nabla \phi = \mathbf{0}$ , it follows that  $\text{rot } \mathbf{E} = \mathbf{0}$ . This, however seems to contradict with the Maxwell equation  $\text{rot } \mathbf{E} = -\partial\mathbf{B}/\partial t$  unless the magnetic field is not varying in time. Thus, evidently, the introduction of a scalar potential  $\phi$  seems to be restricted to a static DC field situation only. These facts are however not realistic for an AC conduction field solver. If some kind of low frequency approximation is used could this be specified?
- 2) In equation (1) the Maxwell relationship  $\text{rot } \mathbf{H} = \mathbf{J} + \partial\mathbf{D}/\partial t$  is used, whereby the current density  $\mathbf{J}$  can be substituted by  $\mathbf{J} = \sigma\mathbf{E}$  and the second term can be substituted by  $j\omega\epsilon\mathbf{E}$ , given a harmonic time dependency  $\exp(j\omega t)$ . This would yield the expression  $\nabla \cdot [\sigma\mathbf{E} + j\omega\epsilon\mathbf{E}] = 0$ . Why is in the first term of expression (1) the electric field strength expressed by  $\mathbf{E}$ , while it is in the second term expressed as  $-\nabla\phi$  and a harmonic time dependency  $\exp(-j\omega t)$ ? Given the foregoing explanation “The AC conductor field simulator solves for the electric potential.....” one would expect an equation involving only  $\phi$ . What is the deeper reason for the mixing of the two possibilities to express the electric field strength in equation (1) and the apparent use of the unconventional time dependence  $\exp(-j\omega t)$ ?
- 3) On page 20 the magnetic field strength  $\mathbf{H}$  is called the B-field  $\mathbf{H}(t)$ , but this might give some confusion with the also present, but quite different magnetic flux density field  $\mathbf{B}(t)$ . It seems more appropriate to refer to  $\mathbf{H}(t)$  as the magnetic field strength and not as the B-field. Moreover, sometimes the B-field (e.g. on page 27 a few lines above figure 3.7) is expressed in T and not in A/m, which complicates things further.
- 4) From the combination  $(\sigma + j\omega\epsilon)$  in equation (4) it can be concluded that the conventional time dependency  $\exp(j\omega t)$  is used. This seems to be in contradiction with the expression in equation (1) on the foregoing page, which seems to imply another time dependency as already mentioned above.
- 5) On page 23 is in table 3.1 the conductivity of seawater expressed as 5 S/m. This, however, contradicts the (more realistic!) value of 4 S/m given on page 29 (a few lines beneath figure 3.9). I would strongly recommend the use of 4 S/m consistently throughout the report.
- 6) In the cross section shown in figure 3.7 on page 27 the magnetic flux density appears to be isotropic, which is also stressed at the bottom of page 26. In my opinion this is only true, when the media are perfect isolators with the same magnetic properties. However, both seawater and marine sediment are conducting media and thus (influenced by the secondary electric field) eddy currents will flow in these media, which tend to reduce the magnetic field! This has two consequences. First due to these eddy currents in the surrounding media the resulting magnetic field strength will be significantly reduced. Secondly, since the conducting properties of seawater and marine sediment are different, the resulting magnetic field will be different in both media and thus the magnetic field will no longer be radially symmetric!
- 7) On page 28 in equation (7) an expression is given for the magnetic field strength  $\mathbf{H}$  and the current densities  $\mathbf{J}_e$  and  $\mathbf{J}_d$ . The description indicates that in this program the magnetic field calculated earlier is used as input and that from this equation the total



current density is calculated and thus by virtue of equation (8) the electric field strength. However, this seems to be incorrect, because this relation is actually used to calculate the magnetic field when the current density is given. Instead the relationship  $\nabla \times \mathbf{E} = -\partial \mathbf{B} / \partial t$  should be used to calculate the induced electric field and then the resulting electric field is to be used in (8) to calculate the total complex current density and from that via (7) the accompanying magnetic field, which thus expresses the “additional” or “scattered” field created by the eddy current density  $\mathbf{J}_e = \sigma \mathbf{E}$  and the dielectric displacement current density  $j\omega \epsilon \mathbf{E}$  in the surrounding media. This is thus to be clearly discriminated from the original or ‘incident’ magnetic field  $\mathbf{H}_i$  due to the currents flowing in the cable conductors as calculated earlier on page 26 and 27. My suggestion would be to attach a suffix (e.g.  $\mathbf{H}_s$ ) to the magnetic field used in (7) in order to discriminate one from the other. Now, due to this additional field the total magnetic field will decrease (Lenz law) in amplitude and thus the induced currents will reduce, which will again reduce the additional field etc. etc. In order to avoid this recursive calculation scheme the additional field  $\mathbf{H}_s$  (expressed in equation (7)) is to be added to the original magnetic field  $\mathbf{H}_i$  in order to calculate the total field  $\mathbf{H}_t = \mathbf{H}_i + \mathbf{H}_s$ . From this total field  $\mathbf{H}_t$  the induced electric field must be calculated by Faraday’s law  $\nabla \times \mathbf{E} = -\partial \mathbf{B} / \partial t$  in order to calculate the resulting electric field. Summarizing, we get the following calculation scheme:

$$\nabla \times \mathbf{E} = -\partial \mathbf{B} / \partial t = -\partial / \partial t \mu(\mathbf{H}_i + \mathbf{H}_s)$$

$$\nabla \times \mathbf{H}_s = \mathbf{J}_e + \mathbf{J}_d = (\sigma + j\omega \epsilon) \mathbf{E}$$

Elimination of  $\mathbf{H}_s$  from these two equations makes it possible to relate the induced electric field to the incident magnetic field. It seems to me that numerical values of the produced electric field will consequently be different from the values given in the report.

- 8) Pondering on these results a mechanism emerges, whereby electric fields and currents are induced in the surrounding media, much like as if a transformer is installed, which is fed on the primary side by the conductor currents and loaded on the secondary side by the conductance of the surrounding media. As a result energy is taken away from the power cable and through this transformer dissipated in the surrounding media, which are thus raised in temperature. These media are heated by the power lost in the cable. This argument should be a drive for cable constructors to further reduce the magnetic leakage of the cables, not only from an environmental perspective, but also from an economical (!) perspective. Any improvement in cable leakage will be rewarded by reduced cable losses. This may sound as a win-win situation for both cable constructors and environmentalists!
- 9) Since the conductivity of a medium will by the creation of eddy currents reduce the magnetic field it is strange that on page 29 under figure 3.9 it is concluded that the fields are at comparable distances weaker in the seabed than in the better conducting seawater.
- 10) Also the conclusion “Hence , the induced current densities are effectively the same....” drawn at the bottom of page 29 becomes doubtful. One should always get a monotonically decreasing magnetic field strength as a function of distance. Therefore, it seems strange that the burial depth of 1 metre has no significant effect.
- 11) In appendix II the coupling capacitor of 100 nF between the first and second amplifier stage in the magnetic field sensor seems too small, since the low frequency cut-off frequency becomes approximately 160 Hz, which will introduce significant loss for a 50 Hz signal, thereby decreasing the signal to noise ratio. It is furthermore noticed that the performance could easily be upgraded further, when the broadband amplifiers

are replaced by bandpass amplifiers with a centre frequency around 50 Hz and with a relatively small bandwidth.

- 12) The third order bandpass filter used in the electric field sensor seems to be not adequately tuned to the centre frequency of 50 Hz. Due to the high resistance value of 33 M $\Omega$  in the feedback loop combined with the two 10 nF capacitors the centre frequency becomes too low.

**Responses to Questions regarding the report COWRIE-EMF-01-2002 “A Baseline study of electromagnetic fields generated by offshore windfarm cables.**

In general:

For a time-varying field, we have

$$E = -j\omega A - \nabla\phi \text{ and } \phi = -\nabla \cdot A / (j\omega\mu\epsilon)$$

From Maxwells equations:

$$\nabla \times H = J + \frac{dD}{dt} = J + j\omega\epsilon E$$

We have:

$$\nabla \cdot \nabla \times H = 0 = \nabla \cdot (J + j\omega\epsilon E) = \nabla \cdot (\sigma E + j\omega\epsilon E)$$

or

$$\nabla \cdot (\sigma E + j\omega\epsilon E) = 0$$

This should be Equation (1) (replacing  $\nabla\phi$  by  $E$ ). Thus there is no need for the introduction of the electric scalar potential  $\phi$ . The way that equation is written might therefore cause some confusion.

Point 1:

See general point above regarding scalar quantity.

No low frequency approximation used.

Point 2:

See general point above regarding the scalar quantity.

The use of the jōt arises from the time differential.

Point 3:

B –field should read H-field.

Figure 3.6 shows the magnetic flux (H) around the cables. So the text in the third sentence in the first paragraph that begins section 3.3.1.2 should read “Figure 3.6 shows the simulated magnetic flux (H) inside the cable at different phases. It can be seen that the magnetic fluxes have temporal rotation along the axis of the cable (fig 3.6).”

Point 4:

As general point above and point 2.

Point 5:

The conductivity of seawater changes with depth and location. There is no typical value but there are a range of values. The simulations have been performed for 4 S/m and therefore the figure of 5 in table 3.1 is a misprint should read 4.

Point 6:

The reluctances of the water and sea bed have the same value as the permeability for both media is the same. The figure (3.7) refers to the magnetic field outside of the cable when buried and solely due to the cable.

Point 7:

The calculation produces the eddy currents induced in the sea water and then estimates the electric field that would arise from this only. The situation is far more complex than the simple model suggests in the there is no movement of water passed the cable which will add to the electric field.

Point 8:

Power loss from the cable was not calculated. But agree there will be a loss of power which will heat the surrounding medium. The reduction in this loss of energy may provide economic savings and may over a period of time repay the extra cost of lower emission cables.

Point 9:

Figure 3.9 shows current density. The first paragraph below figure 3.9 compares current density just above the cable and 8 metres from it in the sea bed. The eddy currents are expected to be larger in the more conducting medium.

Point 10:

Paragraph 2 needs to be read carefully. Consideration should be given to the induced currents on the surface of the seabed which is around 1 metre from the cable. The induced currents are larger in the more conducting medium. The statement refers to the current density being the same as around the skin but clearly this will only be true for a limited set of spatial coordinates.

Point 11:

The introduction of the 100nF capacitor is to reduce a very low frequency due to movement of the sensor and will results in loss of signal at 50Hz. Subsequent improvements have been made to the hardware.

Point 12:

Value of the diagram is incorrect. It was the value in the initial design but was subsequently changed to a low value to achieve the correct frequency response.

## **Appendix 12**

### **FOOD AND ENVIRONMENT PROTECTION ACT 1985 (AS AMENDED)**

#### **Licence conditions for UK offshore wind farms relating to fish and electromagnetic/electrical fields**

##### **North Hoyle**

Licence 31579/03/1

#### **9.5 Monitoring of Sedimentary and Hydrological Processes, Benthic Ecology, Electromagnetic Fields and Noise & Vibration**

The Licence Holder must carry out a programme of sedimentary, hydrological, benthic and other monitoring, as outlined in Annex 1 attached to this Schedule. The full specification for the monitoring programme will be subject to separate written agreement with the Licensing Authority following consultation with CEFAS and the Countryside Council for Wales prior to the proposed commencement of the monitoring work.

#### **9.7 Fish Monitoring**

Since very little is known about the potential effect of wind farms in terms of enhancing or aggregating fish populations, the Licence Holder must produce proposals for a postconstruction survey of fish populations in the area of the wind farm. The Licence Holder shall, in drawing up such proposals, canvas the views of local fishermen. The proposals must be submitted to the Licensing Authority within 3 months of completion of construction of the wind farm.

Annex 1 (Monitoring Requirements)

#### **4. Marine Fish**

(See licence condition 9.7).

#### **5. Electromagnetic Fields**

The Licence Holder must provide the Licensing Authority with information on attenuation of field strengths associated with the cables, shielding and burial described in the Method Statement and relate these to data from the RØdsand windfarm studies in Denmark and any outputs from the COWRIE sponsored studies in the UK. This is to provide reassurance that the cable shielding and burial depth(s), given the sediment type, at the North Hoyle site is sufficient to ensure that the electromagnetic field generated is negligible. Should this study show that the field strengths associated with the cables are sufficient to have a potentially detrimental effect on electrosensitive species, further biological monitoring may be required to further investigate the effect.

## **Scroby Sands**

Licence 31272/02/0

No specific conditions relating to fish or electromagnetic/electrical fields. Two metre beam trawls with 9mm mesh cod end are specified in the monitoring and although targeted at benthic epifauna these will sample some elements of the fish community.

## **Rhyl Flats**

Licence 31640/02/0

### **9.5 Monitoring of Sedimentary and Hydrological Processes, Benthic Ecology, Electromagnetic Fields and Noise & Vibration**

The Licence Holder must carry out a programme of sedimentary, hydrological, benthic and other monitoring, as outlined in Annex 1 attached to this Schedule. The full specification for the monitoring programme will be subject to separate written agreement with the Licensing Authority following consultation with CEFAS and the Countryside Council for Wales at least one month prior to the proposed commencement of the monitoring work.

### **9.7 Fish Monitoring**

Since very little is known about the potential effect of wind farms in terms of enhancing or aggregating fish populations, the Licence Holder must produce proposals for adequate preconstruction baseline and post-construction surveys of fish populations in the area of the wind farm. The Licence Holder shall, in drawing up such proposals, canvas the views of local fishermen. The proposals must be submitted to the Licensing Authority at least one month prior to the proposed commencement of the monitoring work. (See also Annex 1 in relation to monitoring of electro-sensitive species).

Annex 1 (Monitoring Requirements)

## **5. Electromagnetic Fields**

The Licence Holder must provide the Licensing Authority with information on attenuation of field strengths associated with the cables, shielding and burial described in the Method

Statement and relate these to data from the RØdsand wind farm studies in Denmark and any outputs from the COWRIE tendered studies in the UK. This is to provide reassurance that the cable shielding and burial depth(s), both between the turbines and along the route to shore, given the sediment type(s) at the Rhyl Flats site are sufficient to ensure that the electromagnetic field generated is negligible. Should this study show that the field strengths associated with the cables are sufficient to have a potentially detrimental effect on electrosensitive species, further biological monitoring to that described in section 5 may be required to further investigate the effect.

## **6. Marine Fish**

(See also licence condition 9.7 in relation to fish populations).

The Environmental Impact Assessment observed electrosensitive species (e.g. Thornback Ray) both within and close to the Rhyl Flats site. In the absence of any evidence that electromagnetic fields do not pose a risk to such organisms, monitoring work is required to determine the numbers and distribution of such species in the vicinity of the Rhyl Flats offshore wind farm (this should include the establishment of a baseline and the use of adequate controls). The survey should make use of non-destructive techniques e.g. live traps and visual methods. The results should be presented and discussed in combination with the EMF studies described in the preceding section (5).

## **Kentish Flats**

Licence 31780/03/0

### **Monitoring of Sedimentary and Hydrological Processes, Benthic Ecology, Electromagnetic Fields and Noise & Vibration**

9.4 The Licence Holder must carry out a programme of sedimentary, hydrological, benthic and other monitoring, as outlined in Annex 1 attached to this Schedule. The full specification for the monitoring programme will be subject to separate written agreement with the Licensing Authority following consultation with CEFAS and English Nature at least one month prior to the proposed commencement of the monitoring work.

9.6 Since very little is known about the potential effect of wind farms in terms of enhancing or aggregating fish populations, the Licence Holder must produce proposals for adequate preconstruction baseline and post-construction surveys of fish populations in the area of the wind farm. These surveys should, as a minimum, comprise some seasonal surveys of fish populations in the region before construction and during the first year of the operational phase and should consider both demersal and pelagic species. The Licence Holder shall, in drawing up such proposals, canvas the views of local fishermen. The proposals must be submitted to the Licensing Authority at least one month prior to the proposed commencement of the monitoring work.

Annex 1 (Monitoring Requirements)

#### **5. Electromagnetic Fields**

The Licence Holder must provide the Licensing Authority with information on attenuation of field strengths associated with the cables, shielding and burial described in the Method Statement and relate these to data from the RØdsand windfarm studies in Denmark and any outputs from the COWRIE sponsored studies in the UK. This is to provide reassurance that the cable shielding and burial depth(s), given the sediment type, at the Kentish Flats site is sufficient to ensure that the electromagnetic field generated is negligible. Should this study show that the field strengths associated with the cables are sufficient to have a potentially detrimental effect on electrosensitive species, further biological monitoring may be required to further investigate the effect.



## **Barrow**

Licence 31744/03/3

### **Monitoring of Sedimentary and Hydrological Processes, Benthic Ecology, Electromagnetic Fields and Noise & Vibration**

9.4 The Licence Holder must carry out a programme of sedimentary, hydrological, benthic and other monitoring, as outlined in Annex 1 attached to this Schedule. The full specification for the monitoring programme (to be prepared by the Licence Holder) will be subject to separate written agreement with the Licensing Authority following consultation with CEFAS and English Nature at least one month prior to the proposed commencement of the monitoring work.

### **Fish Monitoring**

9.6 Since very little is known about the potential effect of windfarms in terms of enhancing or aggregating fish populations, the Licence Holder must produce proposals for adequate pre-construction baseline and post-construction surveys of fish populations in the area of the windfarm. The Licence Holder shall, in drawing up such proposals, canvas the views of local fishermen. The proposals must be submitted to the Licensing Authority at least one month prior to the proposed commencement of the monitoring work. (See also Annex 1 in relation to monitoring of electro-sensitive species).

Annex 1 (Monitoring Requirements)

### **6. Electromagnetic Fields**

The Licence Holder must provide the Licensing Authority with information on attenuation of field strengths associated with the cables, shielding and burial described in the Method Statement and related to data from the Rødsand windfarm studies in Denmark and any outputs from the COWRIE tendered studies in the UK. This is to provide reassurance that the cable shielding and burial depth(s), both between the turbines and along the cable route to shore, given the sediment type(s) at the Barrow site are sufficient to ensure that the electromagnetic field generated is negligible. Should this study show that the field strengths associated with the cables are sufficient to have potential detrimental effect on electrosensitive species, further biological monitoring to that described in Section 7 of this Annex may be required to further investigate the effect.

### **7. Marine Fish**

(See also Supplementary Licence Condition 9.7)

The Environmental Impact Assessment observed electrosensitive species (e.g. Thornback Ray, Basking Shark) in Morecambe Bay and in the vicinity of the Barrow site. In the absence of any evidence that electromagnetic fields do not pose a risk to such organisms, monitoring work is required to determine the numbers and distribution of such species in the vicinity of the Barrow offshore windfarm (this should include the establishment of a baseline and the use of adequate controls). The results should be presented and discussed in combination with the EMF studies described in the preceding section (6).

## **Burbo**

Licence 31864/03/0

### **Monitoring of Sedimentary and Hydrological Processes, Benthic Ecology, Electromagnetic Fields and Noise & Vibration**

9.4 The Licence Holder must carry out a programme of sedimentary, hydrological, benthic and other monitoring, as outlined in Annex 1 attached to this Schedule. The full specification for the monitoring programme must be drafted by the applicant and submitted to the Licensing Authority at least three months prior to the proposed commencement of the monitoring work. The Licensing Authority will issue separate written agreement following consultation with CEFAS and English Nature at least one month prior to the commencement of the monitoring work.

### **Fish Monitoring**

9.6 Since very little is known about the potential effect of windfarms in terms of enhancing or aggregating fish populations, the Licence Holder must produce proposals for adequate pre-construction baseline and post-construction surveys of fish populations in the area of the windfarm giving strong consideration to non-destructive methods of monitoring. The Licence Holder shall, in drawing up such proposals, canvas the views of local fishermen, North West and North Wales Sea Fisheries Committee. The proposals must be submitted to the Licensing Authority at least three months prior to the proposed commencement of the monitoring work. Written agreement from the Licensing Authority is required at least one month prior to the commencement of the monitoring work. (See also Annex 1 in relation to monitoring of electro-sensitive species).

## **6. Electromagnetic Fields**

The Licence Holder must provide the Licensing Authority with information on attenuation of field strengths associated with the cables, shielding and burial described in the Method Statement (to be submitted to the Licensing Authority as a matter of urgency) and related to data from the Rødsand windfarm studies in Denmark and any outputs from the COWRIE tendered studies in the UK (where appropriate). This is to provide reassurance that the cable shielding and burial depth(s), both between the turbines and along the cable route to shore, given the sediment type(s) at the Burbo site are sufficient to ensure that the electromagnetic field generated is negligible. Should this study show that the field strengths associated with the cables are sufficient to have potential detrimental effect on electrosensitive species, further biological monitoring to that described in Section 7 of this Annex may be required to further investigate the effect.

## **7. Marine Fish**

(See also Supplementary Licence Condition 9.7)

The Environmental Impact Assessment observed electrosensitive species (eg Thornback Ray) in this area of Liverpool Bay and in the vicinity of the Burbo site (although frequency and abundance were not quantified). In the absence of any evidence that electromagnetic fields do not pose a risk to such organisms, monitoring work is required to determine the numbers and distribution of such species in the vicinity of the Burbo offshore windfarm (this should include the establishment of a baseline and the use of adequate controls). The results should be presented and discussed in combination with the EMF studies described in the preceding section (6).

## **Lynn**

Licence 31792/03/0

### **Monitoring of Sedimentary and Hydrological Processes, Benthic Ecology, Electromagnetic Fields and Noise & Vibration**

9.5 The Licence Holder must carry out a programme of sedimentary, hydrological, benthic and other monitoring, as outlined in Annex 1 attached to this Schedule. The full specification for the monitoring programme (to be prepared by the applicant) will be subject to separate written agreement with the Licensing Authority at least 6 weeks prior to the proposed commencement of the monitoring work following consultation with CEFAS and English Nature.

### **Fish Monitoring**

9.8 Since very little is known about the potential effect of windfarms in terms of enhancing or aggregating fish populations, the Licence Holder must produce proposals for adequate pre-construction baseline and post-construction surveys of fish populations in the area of the windfarm. The Licence Holder shall, in drawing up such proposals, canvas the views of local fishermen. The proposals must be submitted to the Licensing Authority at least one month prior to the proposed commencement of the monitoring work. (See also Annex 1 in relation to monitoring of electro-sensitive species).

### **6. Electromagnetic Fields**

The Licence Holder must provide the Licensing Authority with information on attenuation of field strengths associated with the cables, shielding and burial described in the Method Statement (to be submitted to the Licensing Authority as soon as possible) and related to data from the Rødsand windfarm studies in Denmark and any outputs from the COWRIE tendered studies in the UK (where appropriate). This is to provide reassurance that the cable shielding and burial depth(s), both between the turbines and along the cable route to shore, given the sediment type(s) at the Lynn site are sufficient to ensure that the electromagnetic field generated is negligible. Should this study show that the field strengths associated with the cables are sufficient to have potential significant adverse effects on electro-sensitive species, further biological monitoring to that described in Section 7 of this Annex may be required to further investigate the effect.

### **7. Marine Fish**

(See Supplementary Licence Condition)

The Environmental Impact Assessment observed electro-sensitive species (e.g. Thornback Ray) in this area of the Lynn site (although the frequency and abundance were not quantified). In the absence of any evidence that electromagnetic fields do not pose a risk to such organisms, monitoring work is required to determine the numbers and distribution of such species in the vicinity of the Lynn windfarm (this should include the establishment of a baseline and the use of adequate controls). The results should be presented and discussed in combination with the EMF studies described in the preceding section (6).

## **Robin Rigg**

Scottish FEPA Licence condition 23 states *“The licensee shall prior to construction of the windfarm, provide the licencing authority with a report on “best practice” relating to the attenuation of field strengths of cables by shielding or burial designed to minimise the effects on electro-sensitive species. Such “best practice guidance” as is identified shall be incorporated into a working method statement of the Robin Rigg development.”*

English CPA Consent condition 4 states; *“Development should not commence until a scheme has been submitted to and agreed in writing by English Nature relating to the method of cable burial. You should also liaise with English Nature on the development of suitable mitigation measures, and the design of any ongoing monitoring of the interaction between the cable and both Elasmobranch fish and sabellaria.”*