

FINAL REPORT

Integration and Validation of Avian Radars (IVAR)

ESTCP Project RC-200723

July 2011

Marissa Brand
Space and Naval Warfare Systems Center Pacific

Gerald Key, Dr. J. Timothy Nohara, Dr. Robert Beason
Accipiter Radar Technologies, Inc.

Dr. Ed Herricks
University of Illinois at Urbana-Champaign

Ryan King
Federal Aviation Administration

Dr. Sidney Gauthreaux, Jr.
Clemson University

Mike Begier, Christopher Bowser
United States Department of Agriculture

James Swift
Naval Air Systems Command

Matt Klope
Naval Facilities Engineering Command

Hermann Griese, MAJ Christopher Dotur
Elmendorf AFB

This document has been cleared for public release



REPORT DOCUMENTATION PAGE

Form Approved
OMB No. 0704-0188

Public reporting burden for this collection of information is estimated to average 1 hour per response, including the time for reviewing instructions, searching data sources, gathering and maintaining the data needed, and completing and reviewing the collection of information. Send comments regarding this burden estimate or any other aspect of this collection of information, including suggestions for reducing this burden to Washington Headquarters Service, Directorate for Information Operations and Reports, 1215 Jefferson Davis Highway, Suite 1204, Arlington, VA 22202-4302, and to the Office of Management and Budget, Paperwork Reduction Project (0704-0188) Washington, DC 20503.

PLEASE DO NOT RETURN YOUR FORM TO THE ABOVE ADDRESS.

1. REPORT DATE (DD-MM-YYYY) 28/07/2011		2. REPORT TYPE Final Report		3. DATES COVERED (From - To) January 1, 2001 - January 1, 2010	
4. TITLE AND SUBTITLE Integration and Validation of Avian Radars				5a. CONTRACT NUMBER	
				5b. GRANT NUMBER	
				5c. PROGRAM ELEMENT NUMBER	
6. AUTHOR(S) Brand, Marissa; Key, Gerald; Herricks, Dr. Ed; King, Ryan; Nohara, Dr. J. Timothy; Gauthreaux, Dr. Sidney, Jr.; Begier, Mike; Bowser, Christopher; Beason, Dr. Robert; Swift, James; Klope, Matt; Griese, Hermann; Dotur, MAJ Christopher.				5d. PROJECT NUMBER RC-200723	
				5e. TASK NUMBER	
				5f. WORK UNIT NUMBER	
7. PERFORMING ORGANIZATION NAME(S) AND ADDRESS(ES) SPAWARSYSCEN PACIFIC, 53560 Hull Street, San Diego, CA 92152; Clemson University, Clemson, SC 29634; Accipiter Radar Technologies, Inc., 576 Highway 20 West, P.O. Box 939, Fonthill, Ontario, Canada.				8. PERFORMING ORGANIZATION REPORT NUMBER	
9. SPONSORING/MONITORING AGENCY NAME(S) AND ADDRESS(ES) Environmental Security Technology Certification Program (ESTCP) 901 North Stuart Street, Suite 303, Arlington, VA 22203				10. SPONSOR/MONITOR'S ACRONYM(S) ESTCP	
				11. SPONSORING/MONITORING AGENCY REPORT NUMBER RC-200723	
12. DISTRIBUTION AVAILABILITY STATEMENT Approved for public release; distribution is unlimited.					
13. SUPPLEMENTARY NOTES					
14. ABSTRACT A team of scientists and engineers from the federal government, industry, and academia is evaluating the ability of digital radar systems to identify and track biological targets and then validating these systems under realistic operational conditions. The eBirdRad radar unit utilizes off the shelf X-band marine radar coupled with advanced digital signal processing and tracking algorithms to process target information. The overall objectives of the IVAR project include: 1) the use of independent visual, thermal and other observations to validate automatic detection, tracking and display of targets in real time; 2) demonstrate the statistical validity of sampling protocols for bird activity; 3) validate protocols and algorithms for streaming real-time bird track data from multiple sites for immediate display and subsequent analysis; 4) demonstrate algorithms for fusing data from multiple radars; 5) capture baseline data on bird activity at the demonstration sites; and 6) develop objective criteria for functional, performance, and interoperability requirements of these radars, and to guide research to extend avian radar technology.					
15. SUBJECT TERMS					
16. SECURITY CLASSIFICATION OF:			17. LIMITATION OF ABSTRACT UU	18. NUMBER OF PAGES 366	19a. NAME OF RESPONSIBLE PERSON Marissa Brand
a. REPORT U	b. ABSTRACT U	c. THIS PAGE U			19b. TELEPHONE NUMBER (Include area code) 619-553-5334

Table of Contents

List of Tables	vi
List of Figures	ix
List of Acronyms	xix
Acknowledgments.....	xxii
Authors' Note.....	xxiv
EXECUTIVE SUMMARY	xxv
1 INTRODUCTION	1
1.1 BACKGROUND	1
1.2 OBJECTIVE OF THE DEMONSTRATION.....	2
1.3 REGULATORY DRIVERS	6
2 TECHNOLOGY/METHODOLOGY DESCRIPTION	9
2.1 TECHNOLOGY/METHODOLOGY OVERVIEW.....	9
2.2 DOD AND FAA AVIAN RADAR DEVELOPMENT	10
2.3 USER/IVAR PROJECT REQUIREMENTS.....	12
2.4 TECHNOLOGY/METHODOLOGY DEVELOPMENT	13
2.4.1 Operational Definition of “Real Time”.....	13
2.4.2 BirdRad - Analog Radars with Manual Tracking.....	14
2.4.3 eBirdRad – Digital Radars with Automatic Tracking.....	17
2.4.4 FAA/CEAT Accipiter® AR-1 and AR-2 radars.....	21
2.5 ADVANTAGES AND LIMITATIONS OF THE TECHNOLOGY/ METHODOLOGY	24
3 PERFORMANCE OBJECTIVES	26
3.1 SUMMARY DESCRIPTION OF PERFORMANCE OBJECTIVES.....	34
3.1.1 Automatic Tracking	34
3.1.2 Sampling Protocols	37
3.1.3 Data Streaming.....	40
3.1.4 Data Integration	41
3.1.5 Data Fusion	42
3.1.6 Additional Criteria	43
4 STUDY LOCATIONS.....	45
4.1 MCAS CHERRY POINT	48
4.2 NAS PATUXENT RIVER	50
4.3 NAS WHIDBEY ISLAND.....	51
4.4 ELMENDORF AFB	52

4.5	SEATTLE-TACOMA INTERNATIONAL AIRPORT	54
4.6	EDISTO ISLAND.....	55
4.7	ACCIPITER RADAR TECHNOLOGIES, INC.....	56
5	TEST DESIGN	58
5.1	CONCEPTUAL TEST DESIGN.....	58
5.2	BASELINE CHARACTERIZATION AND PREPARATION.....	59
5.3	DESIGN AND LAYOUT OF TECHNOLOGY AND METHODOLOGY COMPONENTS	60
5.4	FIELD TESTING.....	60
5.5	SAMPLING PROTOCOL	64
5.6	SAMPLING RESULTS.....	65
6	PERFORMANCE ASSESSMENT	66
6.1	AUTOMATIC TRACKING.....	66
6.1.1	Quantitative Performance Criteria	66
6.1.2	Qualitative Performance Criteria	125
6.2	SAMPLING PROTOCOL.....	137
6.2.1	Quantitative Performance Criteria	137
6.2.2	Qualitative Performance Criteria	160
6.3	DATA STREAMING	199
6.3.1	Quantitative Performance Criteria	199
6.4	DATA INTEGRATION	225
6.4.1	Quantitative Performance Criteria	225
6.5	DATA FUSION	232
6.5.1	Quantitative Performance Criteria	232
6.6	ADDITIONAL CRITERIA	257
6.6.1	Quantitative Performance Criteria	257
6.6.2	Qualitative Performance Criteria	260
6.7	OTHER AVIAN RADAR SYSTEMS	269
6.8	FUNCTIONAL REQUIREMENTS AND PERFORMANCE SPECIFICATIONS	275
7	COST ASSESSMENT	276
7.1	COST MODEL	276
7.2	COST DRIVERS	283
7.3	COST ANALYSIS AND COMPARISON.....	283
8	IMPLEMENTATION ISSUES	286
9	REFERENCES	291

APPENDIX A. POINTS OF CONTACT	293
APPENDIX B. ANALYTICAL METHODS SUPPORTING THE EXPERIMENTAL DESIGN	297
APPENDIX C. DATA QUALITY ASSURANCE/QUALITY CONTROL PLAN	333
APPENDIX D. SUPPORTING DATA	335
APPENDIX E. SURVEY OF AIRPORT PERSONNEL USE OF REMOTE DISPLAYS OF AVIAN RADAR INFORMATION	347

List of Tables

Table 1-1. Mapping between IVAR Project Tasks and User Benefits and Capabilities.....	3
Table 2-1. Capabilities of Technologies for Sampling Bird Populations.	25
Table 3-1. Performance Objectives.....	26
Table 4-1. Summary of the IVAR study locations. ‘X’ indicates the specified type of demonstration was conducted at that location; ‘B’ indicates a potential Back-up locations for the specified demonstration.	46
Table 5-1. Dates and types of field tests of automatic tracking.	61
Table 6-1. Locations of spring 2007 and fall 2008 IVAR visual confirmation studies.	66
Table 6-2. Summary of the results from the visual confirmation of birds tracked by avian radar.	69
Table 6-3. The number of Requests for Confirmation that were called by the Radar Team (RT-Calls) or the Visual Teams (VT-Calls) during the fall 2008 studies ⁵	71
Table 6-4. Date, times, and the elevation angle of the eBirdRad antenna during the TI-VPR sampling periods.....	75
Table 6-5. Altitude of the radar beam over the TI-VPR and the diameter of the TI-VPR’s field of view at those altitudes.	79
Table 6-6. Difference between the northing and easting coordinates supplied by the GPS onboard the RCH and those supplied by the radar tracking the RCH.	93
Table 6-7. Column headings of the Track Data Viewer Master Record format.	96
Table 6-8. Column headings of the Track Data Viewer Detailed Record format.....	97
Table 6-9. Geospatial coordinates vs. time of Track ID 111, NAS Patuxent River, Maryland, 24 Sep 2008.	98
Table 6-10. The parameters of targets being tracked simultaneously at Edisto Island, South Carolina on 4 October 2008 between 01:18:20 and 01:18:22 UTC (i.e., a single antenna revolution). The data listed in this table are for the first ten and the last ten tracks of the 234 tracks displayed in Figure 6-22.....	101
Table 6-11. The position of Visual Team (VT) sites relative to the radar at MCAS Cherry Point, plus the computed distances targets must be beyond the VT site or between the radar and the VT sites to be 2.2 km from the radar.	103
Table 6-12. Solitary targets at MCAS Cherry Point that were tracked by eBirdRad at a distance of 2 km or more from the radar and visually confirmed to be birds.....	107
Table 6-13. Key to color-coded update squares in Figure 6-23 through Figure 6-32.....	107
Table 6-14. Dates, times and names of the track history files used to demonstrate 360° coverage by the SEAAR1m radar at SEA.	141
Table 6-15. Number of targets tracked in the specified period of time from each of the compass quadrants around the SEAAR1m. Figure 6-47 through Figure 6-50 present the track history plots for these dates.	146
Table 6-16. Data storage requirements for plots and tracks data files generated by each of five radars operated continuously for one year at the specified locations.	152

Table 6-17. Altitudinal distribution of targets shown in Figure 6-57. Date and time are reported as GMT, all distance measurements are in meters, and all altitudes are above ground level (AGL). Range and Altitude values are from the radar to the target. All values are extracted from the DRP database, except the lower and upper edges of the beam, which are calculated based on the 2.5° beam diameter and the 30° antenna elevation angle.	159
Table 6-18. Performance criteria that provided information to support the demonstration that avian radar systems can sample diurnal and seasonal bird activity patterns. “Section/Page” refers to the location of that Criterion in this document.	160
Table 6-19. Auto Scheduler log entries with timestamps and meanings.	167
Table 6-20. Plots and tracks files generated during test sampling event.	168
Table 6-21. Recorded observations from demonstration of PB3.2.	172
Table 6-22. Output from hourly track count query from the SEAAR2I radar.	187
Table 6-23. Time of sunset and sunrise at Seattle, Washington on the dates used for the demonstration of PB9.2.	195
Table 6-24. The 11 fields used in the comparison of track update records. Excerpt is from the DRP dataset.	200
Table 6-25. Differences found in a field-by-field comparison of the DRP and the RDS datasets generated from the SEAAR2u radar between 20:00-21:00 UTC on 12 September 2009	200
Table 6-26. Results from comparison of the track data recorded locally on a DRP and the same data streamed to an RDS over a wired LAN for a 24-hour of period of continuous operations.	202
Table 6-27. TVW and DRP screen capture timestamps, reference times, and computed latencies.	205
Table 6-28. An example of data exported from TDV to a delimited text file format.	222
Table 6-29. Differences found between the Update Time values of the local DRP dataset and those of the remote RDS dataset from the AR2-1 avian radar at Seattle-Tacoma International Airport on 12 September 2009.	223
Table 6-30. Calculated uptimes for two radars, based on a comparison of the scan times in the plots and tracks records archived locally with the scan times for the same data records that were transmitted over a wireless LAN to a remote RDS.	224
Table 6-31. Calculated latencies from screen captures. All clock time values are reported in UTC.	227
Table 6-32. Latency of live radar feeds from the SEAAR2u and SEAAR2I radars at SEA streamed to separate instances of the TVW application and to a single instance of the COP visualization tool, Google Earth (GE). All real-time clock values are expressed in UTC.	231
Table 6-33. Tracking events selected for demonstration of spatial alignment.	232
Table 6-34. Comparison of corresponding track updates from two radars at NASWI on 13 November 2009.	235
Table 6-35. Summary of computation of spatial misalignment errors (Distance) and a priori spatial uncertainty (Uncertainty) from pairs of radars at three IVAR study locations.	236
Table 6-36. Maximum temporal misalignment calculations.	239

Table 6-37. Number of participants attending formal avian radar trainings sessions during the course of the IVAR project.....	261
Table 6-38a. Configurations of commercial digital avian radar systems: Sensors, Antennas, Digital Processors	274
Table 6-38b. Configurations of commercial digital avian radar systems: Data Management, Connectivity, Data Streaming, Integration and fusion.	268
Table 7-1. Cost Model for a Standalone Avian Radar System.	277
Table 7-2. Cost Model for an Integrated Avian Radar System.....	278
Table 7-3. Cost Model for an Advanced Avian Radar System.....	279
Table 7-4. Estimated cost of a typical avian radar system amortized over a five-year lifespan.	284
Table B-1. Meaning of Confirmed? field values on the RT field data form.....	316
Table B-2. Dates, times, and antenna angles of the TI-VPR recording sessions.	323
Table B-3. Altitude of the radar beam (500 m diameter) over the thermal imager and the diameter of the TI's field of view at those altitudes.	327
Table D-1. The position and behavioral data for 234 targets being tracked simultaneously at Edisto Island, South Carolina, 4 October 2008. The data listed are for the tracks displayed in Figure 6-22 and are for the time interval 01:18:20 to 01:18:22 UTC (i.e., a single antenna revolution).	336
Table D-2. Track history file names used to document continuous data recording from two radars, WIAR1 and WIEBirdRad, at NASWI for a one-week period between 12-18 March 2008.	343
Table E-1. Remote radar display latency (seconds) by computer application. The same airport operation's vehicle was used as a dynamic target for tracking and the observation platform equipped with a PC laptop, the hardware supporting the remote display. A connection to the Port of Seattle's computer network was made using an external wireless USB device.	351

List of Figures

Figure 2-1. Chronology of avian radar developments. [Source: Nohara, et al., 2007]	9
Figure 2-2. Configuration of BirdRad system.	15
Figure 2-3. PPI display from the BirdRad avian radar system, NAS Whidbey Island, 25 March 2002. [Note: The red circles and two sets of parallel blue lines were added after this image was captured).....	16
Figure 2-4. eBirdRad trailer at MCAS Cherry Point	18
Figure 2-5. Interior view of the eBirdRad unit at NAS Patuxent River.....	18
Figure 2-6. Typical display of eBirdRad avian radar system, NAS Patuxent River, 17 April 2007, 21:45 EDT. North is up; radar range setting is 3 nmi (5.5 km), range rings are 0.3 nmi (556 m) apart. Red trails are target tracks; white label at the head of a track is the target’s speed, in knots.	19
Figure 2-7. Components of a digital avian radar system.	20
Figure 2-8. Conceptual diagram of an avian radar network.....	21
Figure 2-9. AR-2 dual-dish system located at SEA (TVW display on left, AR2 dish antennas on right).	22
Figure 2-10. AR-1 (SEAAR1m) array antenna system located at SEA. The Port of Seattle station that provides power and the ASR radar for SEA is in the background.....	23
Figure 2-11. Side view of AR-1 (WIAR1m) avian radar unit at NAS Whidbey Island.	23
Figure 4-1. Map of IVAR study locations. “Sicom” = ARTI.	45
Figure 4-2. MCAS Cherry Point, North Carolina, showing the location of the eBirdRad radar (RT-1) and the visual team (VT) observation sites used in the spring 2007 (’07) and fall 2008 (’08) studies.	48
Figure 4-3. Site C at the Outlying Field (OLF) location in Washington County, North Carolina. The eBirdRad radar at the “OLF Site C (’06)” site was used to monitor bird activity near the location of a proposed runway, while the “Wildlife Refuge (’06)” eBirdRad radar was monitoring bird activity in the adjacent Pocosin Lakes National Wildlife Refuge. Data collected in February 2006 from these two radars were used by the IVAR project in its data fusion studies.	49
Figure 4-4. NAS Patuxent River, Maryland, showing the location of the eBirdRad radar (RT-1) and the visual team (VT) observation sites used in the spring 2007 (’07) and fall 2008 studies. VT site labels without a year designator were used in both 2007 & 2008.	50
Figure 4-5. NAS Whidbey Island, Washington, showing the location of the eBirdRad radar (RT-1) and the visual team (VT) observation sites used in the spring 2007 (’07) and fall 2008 (’08) studies.	51
Figure 4-6. Elmendorf Air Force Base, Alaska, showing the location of the eBirdRad radar (RT-1) and the visual team (VT) observation sites used in the fall 2008 (’08) studies.....	53
Figure 4-7. SEATAC International Airport, showing location of the AR2 avian radar.	55
Figure 4-8. Clemson: Edisto Island location, SC showing the planned site for the TIVPR unit.	56
Figure 4-9. ARTI, showing location of radar tower near corporate offices.....	57

Figure 6-1. Percentage of targets called in a Request for Confirmation that were confirmed to be birds by visual observation.	70
Figure 6-2. Total number of Requests for Confirmation (RFCs) at the four IVAR visual confirmation study locations.....	71
Figure 6-3. The locations of eBirdRad and TI-VPR unit use in the thermal validation studies. The eBirdRad (“RT-1”) unit was located in an agricultural field of Sunny Side Plantation, 8360 Peter’s Point Road, Edisto Island, South Carolina, while the TI-VPR unit (“TT-1”) was located 1295 m away in the yard of a residence at 8176 Peter’s Point Road.	73
Figure 6-4. The basic sensor elements of the TI-VPR, including a 50 kW X-band Furuno model FR2155-BB radar with a vertically-pointing 4° parabolic dish antenna (left), and Radiance I high-resolution thermal imaging camera (right).....	74
Figure 6-5. Time exposure from the TI-VPR Radiance I thermal imager, showing flight trajectories of birds overhead.....	74
Figure 6-6. The polygon around the position of the TI-VPR (red pushpin) used to delimit the sample area for the eBirdRad data collected with a 20° tilt angle of the antenna.	76
Figure 6-7. The polygon around the position of the TI-VPR (red pushpin) used to delimit the sample area for the eBirdRad data collected with a 30° tilt angle of the antenna.	77
Figure 6-8. Diagram of sampling “volumes” of eBirdRad and the TI-VPR (not to scale). The green and yellow denote the sampling volume of the eBirdRad and the red and yellow the sampling volume of the TI-VPR. The yellow indicates the sampling volume of the thermal imager that is within the coverage of eBirdRad. The vertical gray lines represent the edge of the eBirdRad sample polygon depicted in Figure 6-6 and Figure 6-7.....	78
Figure 6-9. Dual display of video from thermal imager (left) and vertically-pointing radar (right).....	79
Figure 6-10. Comparison of 5-minute segments for all thermal imager birds: $y = 1.4874x - 4.0244$, $R_a^2 = 0.6838$, $df = 191$; $r = 0.829$, $v = 94$, $P < 0.001$	81
Figure 6-11. Comparison of 5-minute segments for thermal imager birds at the altitude of the eBirdRad radar beam: $y = 0.1469x - 0.3496$, $R_a^2 = 0.4005$, $df = 191$; $r = 0.639$, $v = 94$, $P < 0.001$	81
Figure 6-12. Comparison of 1-hour sessions for all thermal imager birds: $y = 1.8332x - 84.419$, $R_a^2 = 0.8716$, $df = 15$; $r = 0.943$, $v = 6$, $P < 0.001$	82
Figure 6-13. Comparison of 1-hour sessions for thermal imager birds at the altitude of the eBirdRad radar beam: $y = 0.1805x - 7.7035$, $R_a^2 = 0.8911$, $df = 15$; $r = 0.952$, $v = 6$, $P < 0.001$	82
Figure 6-14. Remote-controlled helicopter (RCH) on the SEA perimeter road with pilot and observer.	85
Figure 6-15. Runway 3 at SEA, showing where the remote helicopter tests were conducted.....	86
Figure 6-16. Tracks of the RCH acquired by the SEAAR1 radar providing flight path information as the target flew along Runway 34L/16R at SEA. The colored lines are the tracks of the RCH, which end as the RCH dipped below the level of the runway and was lost by the radar. The small blocks at the ends of each line denote the position of the RCH when it was lost by the radar. These four lines represent Track IDs 449, 571, 632, and 860.	87

Figure 6-17. Plot of the northing coordinates and elevations of the RCH versus time at SEA on 14 September 2008. Of the two diagonal lines, the red line with error bars (“Helicopter GPS”) represents the northing coordinates of the target based on the GPS on the RCH; the yellow line with triangles (“Track ID 860”) represents the northing coordinates from the SEAAR1m radar. The lower, sinusoidal line with the yellow triangles represents the elevation of the track from the GPS on the RCH. 89

Figure 6-18. Plot of the northing coordinates and elevations of the RCH versus time at SEA on 14 September 2008. Of the two diagonal lines, the red line with error bars (“Helicopter GPS”) represents the northing coordinates of the target based on the GPS on the RCH; the red line with triangles (“Track ID 632”) represents the northing coordinates from the SEAAR1m radar. The lower, sinusoidal line with the yellow triangles represents the elevation of the track from the GPS on the RCH. 90

Figure 6-19. Plot of the easting coordinates and elevations of the RCH versus time at SEA on 14 September 2008. Of the two upper lines, the red line with error bars (“Helicopter GPS”) represents the easting coordinates of the target based on the GPS mounted on the RCH; the yellow line with triangles (“Track ID 860”) represents the easting coordinates from the SEAAR1m radar. The lower, sinusoidal line with the yellow triangles represents the elevation of the RCH based on GPS records. 91

Figure 6-20. Plot of the easting coordinates and elevations of the RCH versus time at SEA on 14 September 2008. Of the two upper lines, the red line with error bars (“Helicopter GPS”) represents the easting coordinates of the target based on the GPS on the RCH; the yellow line with triangles (“Track ID 632”) represents the easting coordinates from the SEAAR1m radar. The lower, sinusoidal line with the yellow triangles represents the elevation of the track from the GPS on the RCH. 92

Figure 6-21. Trajectory of Track ID 111 at NAS Patuxent River, Maryland relative to site VT-2 that visually confirmed the target on 24 September 2008. The blue, red, and green placemarks denote the start, confirmed, and end positions of the target track, respectively. 98

Figure 6-22. The tracks of 234 targets recorded during a single rotation of the eBirdRad avian radar antenna at Edisto Island, South Carolina on 4 October 2009, between 01:18:20 and 01:18:22 UTC. Tracks with white numeric labels (Track_ID) were included in count of total targets; those with no label are targets that were no longer being tracked by the radar and were not included in the total. 100

Figure 6-23. The track of target T22637 (unidentified gull) at MCAS Cherry Point on 30 March 2007. This target was confirmed by visual team VT1. Track update colors: blue = start, red = confirmed, green = end. 111

Figure 6-24. The track of target T64755 (stack of squares in upper-right corner), a Turkey Vulture, at MCAS Cherry Point on 31 March 2007. This target was confirmed by visual team VT2A. Track update colors: blue = start, brown = confirmed on last update. 112

Figure 6-25. The track of target T28698 (Turkey Vulture) at MCAS Cherry Point on 01 April 2007. This target was confirmed by visual team VT3. Track update colors: blue = start, red = confirmed, green = end. 113

Figure 6-26. The track of target T44279 (Turkey Vulture) at MCAS Cherry Point on 01 April 2007. This target was confirmed by visual team VT3A. Track update colors: blue = start, red = confirmed, green = end. 114

Figure 6-27. The track of target T59209 (osprey) at MCAS Cherry Point on 01 April 2007. This target was confirmed by visual team VT2A. Track update colors: blue = start, red = confirmed, green = end.....	115
Figure 6-28. The track of target T7434 (stack of squares near center-top of image), a Turkey Vulture, at MCAS Cherry Point on 02 April 2007. This target was confirmed by visual team VT5.. Track update colors: blue = start, brown = confirmed on last update.	116
Figure 6-29. The track of target T58523 (Turkey Vulture) at MCAS Cherry Point on 02 April 2007. This target was confirmed by visual team VT2A. Track update colors: blue = start, brown = confirmed on last update.	117
Figure 6-30. The track of target T28917 (Turkey Vulture) at MCAS Cherry Point on 02 April 2007. This target was confirmed by visual team VT3. Track update colors: blue = start, red = confirmed, green = end.....	118
Figure 6-31. The track of target T29979 (common loon) at MCAS Cherry Point on 04 April 2007. This target was confirmed by visual team VT3. Track update colors: blue = start, red = confirmed, green = end.....	119
Figure 6-32. The track of target T34710 (Turkey Vulture) at MCAS Cherry Point on 04 April 2007. This target was confirmed by visual team VT3. Track update colors: blue = start, red = confirmed, green = end.....	120
Figure 6-33. Screen capture of birds to the southwest of the radar that are well beyond the perimeter of the MCASCP airfield (outlined in green). These track data are from 6 October 2008. The track labels are the targets' Track ID.....	122
Figure 6-34. Screen capture of birds to the southeast of the radar that are well beyond the perimeter of the MCASCP airfield (outlined in green). These track data are from 6 October 2008. The track labels are the targets' Track ID.....	123
Figure 6-35. Screen capture of birds to the south and northeast of the radar that are well beyond the perimeter of the MCASCP airfield (outlined in green). These track data are from 6 October 2008. The track labels are the targets' Track ID.....	124
Figure 6-36. Near the beginning of the simulation, four groups of separated targets are shown. Detections (represented by green circles) as well as tracks (represented by red squares) are indicated above. The numbers represent the target's speed in knots (1 knot = ~1.8 km/hr).....	127
Figure 6-37. Approximately three minutes after the beginning of the simulation, the targets have progressed and exhibit different behaviors as detailed in the text.	128
Figure 6-38. The progression of the targets three six minutes later after the beginning of the simulation.	129
Figure 6-39. BirdRad display, NAS Patuxent River, 17 April 2007, 23:48 GMT. Yellow areas are returns from the current scan of the radar; blue areas are returns from prior scans of the radar.	130
Figure 6-40. eBirdRad display. Same data and display characteristics as Figure 6-39, but processed and rendered digitally.	131
Figure 6-41. eBirdRad display based on the same data and display characteristics as Figure 6-40, but with clutter suppressed.	132

Figure 6-42. eBirdRad display based on the same data as Figure 6-41, with true trail mode turned off and automatic tracking and track history turned on. The red trails are the positions (“history”) of the target while it was being tracked; the white label at the head of a track is the target’s Track ID.	133
Figure 6-43. TrackDataViewer display of parametric data available for targets being tracked by eBirdRad. Track ID 375 (highlighted) corresponds to a target being tracked in Figure 6-42. The table has been truncated on the right to fit on the page.	134
Figure 6-44. A partial history of target Track ID #375 shown in Figure 6-43 (see also Figure 6-42). Each record in this table represents a separate detection of that target. The table has been truncated on the right to fit on the page ¹⁹	135
Figure 6-45. Image from track history file generated from the plots and tracks data of the WIAR1 radar, recorded on 18 March 2008 between 01:00-02:00 UTC. The fine red lines are the histories of tracked targets and the green circles are target detections that were not formed into tracks.	138
Figure 6-46. Image from the track history file generated from the plots and tracks data of the WIEBirdRad radar, recorded on 18 March 2008 between 12:00-13:00 UTC. The fine red lines are the histories of tracked targets; the green circles are target detections that were not formed into tracks.	139
Figure 6-47. Fifteen-minute (01:55-02:10 GMT) track history for the SEAAR1m radar at SEA, 27 January 2009. The radar is located at the intersection of the eight (radial) coordinate lines.....	142
Figure 6-48. Fifteen-minute (06:04-06:19 GMT) track history for the SEAAR1m radar at SEA, 27 January 2009. The radar is located at the intersection of the eight (radial) coordinate lines.....	143
Figure 6-49. Fifteen-minute (12:30-12:45 GMT) track history for the SEAAR1m radar at SEA, 7 July 2009. The radar is located at the intersection of the eight (radial) coordinate lines.	144
Figure 6-50. Fifteen-minute (02:24-02:39 GMT) track history for the SEAAR1m radar at SEA, 8 October 2009. The radar is located at the intersection of the eight (radial) coordinate lines.....	145
Figure 6-52. An example of birds (Track ID 677) detected during the daytime more than 6 nmi (11 km) southeast of the radar. The center of the radar beam is 760 m higher than the radar but the terrain is 500 m above the radar. Consequently, the birds are approximately 250 m above the terrain; an expected altitude for Common Ravens, a common species in the area. The green ring at 11 km indicates the criterion distance.	148
Figure 6-53. In an example of nighttime bird movement, Track IDs 806 and 869 more than 11 km north-northeast of the radar. These targets might have been nocturnal migrants such as shorebirds, which had begun arriving in the area three days prior. The green ring at 11 km indicates the criterion distance.....	149
Figure 6-54. An example of an aircraft detected and tracked from beyond 11 km. The aircraft has two Track IDs (468 and 478) because it was a large aircraft (likely a Boeing 747) occupying multiple detection cells. Aircraft into and out of the Anchorage International Airport typically followed this same route. The green ring at 11 km indicates the criterion distance.	150
Figure 6-55. Location of point-count sampling sites 1-12 at MCAS, Cherry Point. “R” indicates site of the eBirdRad avian radar.	153

Figure 6-56. Location of point-count sampling sites 13-24 at MCAS, Cherry Point. “R” denotes site of the eBirdRad avian radar.	154
Figure 6-57. Digital image of the display of the eBirdRad radar at Edisto Island, South Carolina on 5 October 2008 GMT. The radar was equipped with a dish antenna that had a 2.5° beam width and was inclined 30° above horizontal. The range rings in the display are in kilometers. The green circles are detections; the red squares with white numbers (Track ID) indicate the current position of a tracked target.	157
Figure 6-58. Auto-Scheduler main calendar interface.	163
Figure 6-59. Auto-Scheduler reservation entry window.	164
Figure 6-60. DRP desktop during radar initialization sequence.	165
Figure 6-61. DRP desktop after “radar transmit” and “start Digitizer” commands.	166
Figure 6-62. DRP Live application launched and processing started.	167
Figure 6-63. Test layout for demonstration of remote radar control.	169
Figure 6-64. Elements of the RRC web interface.	170
Figure 6-65. Sequence step 1: standby command issued to radar.	173
Figure 6-66. Sequence step 2: transmit command issued to radar.	173
Figure 6-67. Sequence step 3: 4 range increase commands issued to radar.	174
Figure 6-68. A 24-hour history plot of the track activity from the SEAAR11 radar at SEA on 19 October 2009.	176
Figure 6-69. A plot of all track activity during a 24-hour period from the SEAAR11 radar at SEA on April 20, 2009.	177
Figure 6-70. A plot of all track activity during a 24-hour period from the SEAAR11 radar at SEA on 13 January, 2009.	178
Figure 6-71. Twelve 2-hour histories produced from the SEAAR11 radar for 19 October 2009.	179
Figure 6-72. TVW application display of the track histories from SEAAR21 radar for a 24-hour period 19 October 2009. The track histories are overlain on a digital aerial image of the area surround the SEATAC International Airport.	181
Figure 6-73. 24-hour kml history.	182
Figure 6-74. Oblique view of kml history, illustrating track height information.	183
Figure 6-75. Live feed from three radars at SEA, as viewed in Google Earth.	184
Figure 6-76. An individual track exported to kml format and viewed in Google Earth.	185
Figure 6-77. A Google Earth display of a track history from SEA. This display was generated using data generated by the TVW application and exported in the kml format.	186
Figure 6-78. Daily, unfiltered, track count as recorded by the SEAAR21 radar over a full year, 01 December 2008 to 30 November 2009.	189
Figure 6-79. Time periods selected for representation as hourly track counts in Figure 6-80 through Figure 6-82.	191
Figure 6-80. Hourly track count over the period of 1-5 December 2008.	192
Figure 6-81. Hourly track over the period of 13-17 April 2009.	192

Figure 6-82. Hourly track count over the period of 21-25 September 2009.....	193
Figure 6-83. Hourly track count for targets tracked by SEAR21 radar at SEA between 1 December 2008 and 5 December 2008.....	196
Figure 6-84. Two-hour track histories generated from the SEAR21 radar at SEA for October 19, 2009.	198
Figure 6-85. Microsoft Excel® workbook of track data from a radar that operated continuously at ARTI for 24 hours and recorded tracks locally on a DRP (left panel), streamed the same data over a wired LAN and stored them on an RDS (middle panel) and the scan-by-scan comparison of two datasets (right panel)	202
Figure 6-86. TVW screen capture of Sample #2 in the PC4.1 demonstration. The filename (16.26.33.jpg) of this image records the local reference time, 16:26:33 EST, (21:26:33 UTC); the timestamp in the lower left of the image records the time when the track data were captured by the DRP (21:26:31 UTC). The latency is the difference (0.02 seconds) between these two time values.	204
Figure 6-87. Locations of three avian radar systems operating at SEA. The AR-2 is comprised of two radars.	208
Figure 6-88. Remote access to the Digital Radar Processor (DRP) software operating the AR- 11 computer provided the wildlife biologists with radar-generated plot and track information on suspected bird targets.....	209
Figure 6-89. TVW alarm region (tan lines) for 15 January 2008 NASWI near-miss event.	214
Figure 6-90. Alarm status pane and Accipiter® Alarm Emailer.....	215
Figure 6-91. TVW screen capture of the formation of the first black-bellied plover tracks at NASWI on 15 January 2008 at 20:44:24 GMT.....	216
Figure 6-92. Alarm triggered as a flock of black-bellied plovers enters the alarm region set for NASWI on 25 January 2008.....	217
Figure 6-93. Email alert from Accipiter® Alarm Emailer.....	217
Figure 6-94. Screen capture of TVW display as the flock of black-bellied plovers reaches the west end of Runway 25 at NASWI on 25 January 2008.	218
Figure 6-95. Screen capture of the flock of black-bellied plovers as it passed farther down Runway 25 at NASWI on 15 January 2008.....	219
Figure 6-96. An example from a dataset loaded into TDV application.	221
Figure 6-97. Comparison of the Update Times from the RDS dataset (left pane) with those from the DRP dataset (middle pane). The right pane indicates if the two Update Time values were the same ('0') or different ('1').....	222
Figure 6-98. Screen captures for Sample #1 (+5 minutes) from the SEAR2u radar at SEA (left) and the AR1 CEAT radar as NASWI (right). Reference time is 13.55.20 UTC.	226
Figure 6-99. Screen captures for Sample #6 (+30 minutes) from the SEAR2u radar at SEA (left) and the AR1 CEAT radar as NASWI (right). Reference time is 14.20.20 UTC.	226
Figure 6-100. Screen captures for Sample #12 (+60 minutes) from the SEAR2u radar at SEA (left) and the AR1 CEAT radar as NASWI (right). Reference time is 14.50.23 UTC.	227
Figure 6-101. Simple connection diagram: SEA radars to workstation at ARTI	228

Figure 6-102. Workstation COP layout. Side-by-side TVW application windows above, with separate feeds from SEAAR2u and SEAAR2u radars at SEA in each window; Google Earth window below, with both live radar feeds presented in a single integrated display (i.e., COP). SEAAR1m is a mobile radar on the ground at SEA that was not used in this demonstration.	230
Figure 6-103. Track histories of target selected from SEAAR1l and SEAAR1u radars at SEA dataset for spatial alignment analysis. The green symbols represent the targets from SEAAR2u and the red represent SEARR1m.	233
Figure 6-104. Track histories of target selected from the datasets for two eBirdRad radars at a site north of MCASCP for spatial alignment analysis. The green symbols represent the western eBirdRad unit the the red symbols the western unit.	234
Figure 6-105. Track histories of targets selected from WIAR1 and WeBirdRad radars at WASNI dataset for spatial alignment analysis. The green symbols represent the WeBirdRad unit and the red the WIAR1.	235
Figure 6-106. Plot of the time offset between the SEAAR2u radar DRP at SEA and the United States NTP time pool.	238
Figure 6-107. Plot of the time offset between the SEAAR2l radar DRP at SEA and the United States NTP time pool.	238
Figure 6-108: COP display showing fused tracks from the WIAR1 and eBirdRad radars at NAS Whidbey Island on 13 November 2009 at 01:55 UTC. Red tracks = WIAR1 radar; green tracks = WIEBirdRad radar.	241
Figure 6-109: TVW display showing tracks from the WIAR1 radar at NASWI on 13 November 2009. The Track ID (only the three least significant digits) of each target is shown for each track update.	242
Figure 6-110: TVW display showing tracks from the eBirdRad radar at NASWI on 13 November 2009. The Track ID (only the three least significant digits) of each target is shown for each track update.	243
Figure 6-111: COP display showing fused tracks from the WIAR1 and eBirdRad radars for the two targets at NASWI on 13 November 2009. The display is zoomed into the region in question so that the <i>fused</i> Track IDs are readable. Note that the fused Track IDs maintained throughout the time interval in question are 358 and 185. East-West and North-South units are shown in kilometers.	244
Figure 6-112: COP display of a highly fused track from the WIAR1 and WeBirdRad radars at NASWI on 13 November 2009. The single target is at the center of the display, moving in a southwesterly direction at a speed of ~19 m/s. Each gray grid cell is a 1 km by 1 km square.	245
Figure 6-113: TVW display showing tracks from the WIAR1 radar at NASWI on 13 November 2009. The Track ID (only the three least significant digits) is shown at each track update. The Track ID of interest is 364.	246
Figure 6-114: TVW display showing tracks from the WeBirdRad radar at NASWI on 13 November 2009. The Track ID (only the three least significant digits) is shown at each track update. The Track IDs of interest are 740, followed by 731.	247

Figure 6-115: COP display showing fused track for the single target tracked by the WIAR1 and WeBirdRad radars at NASWI on 13 November 2009. Track ID 740 came from the WeBirdRad radar, which was the first to detect and track the target. The display is zoomed in to make the *fused* Track ID 740 readable: The grid units are shown in kilometers, and each grid cell is .2km by .2km. 248

Figure 6-116: COP display showing a pair of fused tracks with Track IDs 964 and 607 that are maintained throughout most of the display. 249

Figure 6-117: Integrated tracks (no fusion) from two MCASCP radars deployed to a site in Washington County, North Carolina, on 14 February 2006. The red tracks were generated by the western radar (yellow pushpin near the top-left of the display); the green tracks were generated by the eastern radar (pushpin at the extreme right, midway up the display). These two radars are over 10 km apart. The tracks of interest are those in the overlapped region shown near the middle of the display, contained within the range-azimuth region bounded by the circular range markers and the radial electronic bearing lines. Each gray grid cell in this figure represents a 1 km by 1 km square. 250

Figure 6-118: Zoomed region of interest from two MCASCP radars deployed to a site in Washington County, North Carolina, on 14 February 2006, showing tracks from the respective radars with the Track IDs displayed. No fusion processing was applied. Green Track ID 184 (from eastern radar) and red Track ID 538 (from western radar) are long tracks. 251

Figure 6-119: Region of interest from two MCASCP radars deployed to a site in Washington County, North Carolina, on 14 February 2006, after fusion processing. Green Track ID 184 from the eastern radar and red Track ID 538 from the western radar have been combined into fused Track ID 538. 252

Figure 6-120: SEA SEAAR1m radar tracks over the 13 minute interval of interest on 06 October 2009. The long track extending from about 6 km north to about 5 km south is the flock of interest. The speed of individual tracks in this flock is about 15 m/s. The SEAAR1m radar has good coverage to the west of the airfield because the radar is in a bowl below runway grade, and hence has a natural clutter fence. 253

Figure 6-121: SEA SEAAR2 radar tracks over the 13 minute interval of interest on 06 October 2009. The long track extending from about 6 km north to about 5 km south to the west of the airport represent the flocks interest. The speed of individual tracks in this flock is about 15 m/s. 254

Figure 6-122: TrackIDs shown for both radars (i.e. fusion is not applied yet) at SEA on 06 October 2009. 255

Figure 6-123: Fused Track IDs shown for tracks at SEA on 06 October 2009. 256

Figure 6-124. Letter from NAS Patuxent River Natural Resources Manager to Air Operations confirming the location and conditions for operating the BirdRad (and later eBirdRad) avian radar. 265

Figure 6-125. eBirdRad avian radar at NAS Whidbey Island, showing orange safety cones used to indicate to personnel the safe distance to approach the radar when it is operating. 267

Figure 6-126. eBirdRad unit at Elmendorf Air Force Base in April 2008, prior to mounting the transceiver on the roof of the Operations Building in the background. 268

Figure B-1. Display of simulated targets near the beginning of the simulation. Detections (represented by green circles) as well as tracks (represented by red squares) are indicated. The numbers represent the target's speed in knots (1 knot = ~1.8 km/hr).....	298
Figure B-2. Display of simulated targets several minutes into the simulation, using the same color scheme as described in Figure B-1.....	298
Figure B-3. Example of Furuno 2155BB True Trails mode display.....	300
Figure B-4. Example of the digital rendering by the Accipiter® DRP of the same scene as in Figure B-3.....	300
Figure B-5. Placing flag marking center of VT site at MCAS Cherry Point.....	306
Figure B-6. Using a GPS to record spatial coordinates of VT-2A site at MCAS cherry Point.....	307
Figure B-7. Using compass to locate flags at cardinal compass points around VT Site at MCAS Cherry Point.....	307
Figure B-8. Sampling typical sampling schedule from NAS Patuxent River, Spring 2007. S1, S2, etc. = Session Number; RD=Radar; TH = Thermal Imager; 1, 2, etc. = Observer at that VT site; 1R, 2R, etc. = Recorder at that VT site.....	308
Figure B-9. Flowchart of target confirmation process. RT=Radar Team, VT=Visual Team, RFC=Request for Confirmation.....	311
Figure B-10. The TI-VPR sensors: A Furuno FR2155-BB 50 kW X-band radar with a vertically-pointing parabolic dish (left), and Radiance I high-resolution thermal imaging camera (right).....	319
Figure B-11. Diagram of data acquisition system for the thermal imaging camera and vertically pointing radar system.....	320
Figure B-12. Duplexed image showing radar image with date and time stamp (left) and thermal imaging camera display (right). Because the two images are video-duplexed, time synchronization is not a problem.....	321
Figure B-13. Video Peak Store time exposure showing flight trajectories of birds overhead.....	324
Figure B-14. Dual display of video from thermal imager (left) and vertically-pointing radar (right).....	324
Figure B-15. The polygon around the red pushpin delimits the sample area for the eBirdRad data collected with a 20° tilt.....	325
Figure B-16. The polygon around the red pushpin delimits the sample area for the eBirdRad data collected with a 30° tilt.....	326
Figure B-17. Diagram of sampling “volumes” of eBirdRad and the TI-VPR. The green and yellow denote the sampling volume of the eBirdRad and the red and yellow the sampling volume of the TI-VPR. The yellow indicates the sampling volume of the thermal imager that is within the coverage of eBirdrad. The vertical gray lines represent the edge of the eBirdRad sample polygon depicted in Figure B-15 and Figure B-16.....	329

List of Acronyms

Acronym	Definition
AGL	Above Ground Level
AIP	Airport Improvement Program
ARS	Automated Radar Scheduler
BASH	Bird Aircraft Strike Hazard
BirdRad	Bird Radar
BRD	Biological Resources Division
CEAT	Center of Excellence for Airport Technology
CFAR	Constant False Alarm Rate
CNIC	Commander of Naval Installations Command
CONOPS	Concept of Operations
COP	Common Operational (or Operating) Picture
COTS	Commercial Off-The-Shelf
CSC	Computer Sciences Corporation
DIACAP	DoD Information Assurance Certification and Accreditation Process
DITSCAP	DoD Information Technology Security Certification and Accreditation Process
DOD-PIF	Department of Defense – Partners in Flight
DRP	Digital Radar Processor
DSL	Digital Subscriber Line
EAFB	Elmendorf Air Force Base
eBirdRad	Enhanced Bird Radar
ECAM	Environmental Cost Analysis Methodology
ESA	Endangered Species Act
EVDO	Evolution-Data Optimized
FAA	Federal Aviation Administration
FMCW	Frequency Modulated - Continuous Wave
FTR	Firm Track Range
GB	Gigabyte
GIS	Geographical Information Systems
GMT	Greenwich Mean Time; see also UTC
GPS	Global Positioning System
GUI	Graphical User Interface
HERF	Hazards of Electromagnetic Radiation to Fuel
HERO	Hazards of Electromagnetic Radiation to Ordnance

Acronym	Definition
HERP	Hazards of Electromagnetic Radiation to Personnel
IMM	Interacting Multiple Model
IVAR	Integration and Validation of Avian Radars
JFK	John F. Kennedy International Airport
JRC	Japan Radio Corporation
KML	Keyhole Markup Language
MCASCP	Marine Corps Air Station, Cherry Point, North Carolina
MHT	Multiple Hypothesis Testing
NASPR	Naval Air Station, Patuxent River, Maryland
NAVFAC	Naval Facilities Engineering Command
NASWI	Naval Air Station, Whidbey Island, Washington
NRM	Natural Resources Management
NTP	Network Time Protocol
NTSC	National Television Standards Committee
nmi	Nautical Mile
OHSA	Occupational Health and Safety Administration
OLF	Outlying Field
ORD	Chicago O'Hare International Airport
PC	Personal Computer
P_D	Probability of Detection
P_{FA}	Probability of False Alarm
POR	Program of Record
PPI	Plan Position Indicator
PSG	Pacific Seabird Group
PST	Pacific Standard Time
QA	Quality Assurance
QAP	Quality Assurance Program
QC	Quality Control
RDS	Radar Data Server
RDTE	Research, Development, Test and Evaluation
RFC	Request for Confirmation
RFE	Radar Fusion Engine
RF	Radio Frequency
ROC	Receiver Operating Characteristic
RRC	Radar Remote Controller

Acronym	Definition
RST	Radar Sensor Transceiver
RT	Radar Team
SEA	Seattle-Tacoma International Airport, Washington State
SQL	Structured Query Language
SSC Pacific	Space and Naval Warfare Systems Center Pacific
SSC-SD	Space and Naval Warfare Systems Center San Diego
TDV	Track Data Viewer
TI	Thermal Imager
TI-VPR	Thermal Imager-Vertically Pointing Radar
TVW	TrackViewer Workstation
UAV	Unmanned Aerial Vehicle
USDA	United States Department of Agriculture
USFWS	United States Fish & Wildlife Service
USGS	United States Geological Survey
USN	United States Navy
UTC	Coordinated Universal Time
UTM	Universal Transverse Mercator
VNC	Virtual Network Computing
VPS	Video Peak Store
VT	Visual Team
pVT	Primary Visual Team
sVT	Secondary Visual Team
WAN	Wide Area Network
WGS84	World Geodetic System, 1984 Revision
WiFi	Wireless Fidelity
WS	Wildlife Services

Acknowledgments

Financial support for the IVAR project was provided by the Sustainable Infrastructure program area (now Resource Conservation and Climate Change) of the DOD Environmental Security Technology Certification Program. The IVAR project and the CEAT project (see Section 2.2) shared equipment and other resources at those locations where both projects conducted studies. Finally, the facilities that served as the IVAR study locations made in-kind contributions of staff, vehicles, communications equipment, and other resources in support of this project.

Many people and organizations have contributed to the efforts of the IVAR project. In addition to those individuals listed as Points of Contact in Appendix A, the IVAR team would like to acknowledge the contributions of the following individuals to the overall success of the project:

Accipiter Radar Technologies, Inc.

Sean Clifford	Al Premji
Graeme Jones	Andy Ukraineec
Carl Krasnor	Peter Weber
Julia Moule	

University of Illinois/Center of Excellence for Airport Technology

Wendell Bunch	Dave Mayer
Peter Lazar	Beth Woodworth
Sid Majumdar	

Clemson University/Edisto Island

Carroll Belser

CSC

Sheila O'Brien
Rebecca Streib-Montee

DOD Environmental Security Technology Certification Program (ESTCP)

Dr. John Hall
Dr. Jeffrey Marqusee
John Thigpen

DOD/Partners in Flight

Chris Eberly

Elmendorf Air Force Base

Chris Dotur
David Young
Chuck Benbow

Marine Corps Air Station, Cherry Point

Bill Rogers

Carmen Lombardo

Naval Air Station, Whidbey Island

Bill Applegate	Jill Hein
Ann Casey	Clarence Hein
Linda Dwight	Cody McCloud

Naval Air Station, Patuxent River

Melanie Anderson	Hannah Perrin
Bob Boxwell	Kyle Rambo
Patty Craig	Jackie Smith
Alexis Gray	Beverly and Warren Walker
Paul Parzynski	Kevin Weinelt

USDA/Wildlife Services

Steve Ball	Jerry Morrill
Bob Brunke	Lawrence Shaffer
Jason Gilsdorf	Mike Stevens
Wayne Harris	Patrick Viehoever
Dane Ledbetter	Bill Wilmoth
Dennis Lewis	Keri Yankus

Authors' Note

The first draft of the IVAR Final Report was submitted in March 2010. Because avian radar systems are a rapidly evolving technology, new products continue to appear in the marketplace, as do the results from ongoing avian radar studies. Rather than attempt to keep pace with these moving targets, the authors chose to limit changes in this draft of the Report to those products and data that were available at the time of the first draft. The only known exceptions to this policy have been our mention of the FAA Advisory Circular 150/5220-25 (FAA, 2010) and the Navy and Marine Corps adoption of a BASH program of record – both of which we deemed to be fundamentally important to the application of avian radar technology by the U.S. military, and neither of which changes the basic results and interpretation of the IVAR project.

EXECUTIVE SUMMARY

Military bases and ranges have become refugia for birds and other wildlife as encroachment has turned once-rural military facilities into islands of habitat diversity surrounded by seas of urbanization. This trend is straining the ability of natural resource managers to protect the wildlife while ensuring the military can prepare and train for its primary missions. In parallel, the hazards from and the awareness of bird strikes have continued to increase at military and civilian airfields alike – as the crash of US Airways Flight #1549 into the Hudson River on 15 January 2009 illustrated so vividly. The damage to civilian aircraft in the United States from bird strikes is estimated to be in excess of \$600M/Yr – not to mention the danger these strikes pose to aircrews, passengers, and people on the ground. Resource managers must respond to these escalating trends at a time when they are being asked to “do more with less”. They need better tools to aid them in their efforts: Digital avian radar appears to be such a tool.

Since the 1960s most avian radars have employed conventional marine radars and have been used primarily in ornithological research. Starting in 2000, DoD funded a project to develop inexpensive portable avian radars for natural resources management and bird-strike avoidance applications at military facilities. These systems had numerous advantages over conventional bird sampling methods: They also had limitations that restricted their deployment for operational use. The Navy then funded a project to apply digital signal processing technology to these analog commercial off-the-shelf (COTS) marine radars, with the primary goal of automatically detecting and tracking birds. SSC Pacific, having successfully demonstrated the viability of digital avian radar systems using this enhanced bird radar (eBirdRad) system, formed a team of scientists and engineers from government, industry and academia and submitted a proposal to the Environmental Security Technology Certification Program (ESTCP) to demonstrate and validate whether digital avian radar technology could provide useful and accurate data on bird movements in real-world operational environments at military facilities. This report presents the results of that Integration and Validation of Avian Radars (IVAR) project.

The IVAR project collaborated with a separate project at the Center for Excellence in Airport Technology (CEAT) of the University of Illinois that was funded by the Federal Aviation Administration (FAA) to evaluate the application of avian radar technology at civil airports. The two projects shared resources, personnel, and data. While they reached similar conclusions regarding avian radar technology, the FAA Advisory Circular 150/5220-25 framed its functional requirements and performance specifications primarily in terms of the operational environment of civil airports.

The IVAR team’s Performance Objectives were designed to evaluate digital avian radars with regard to:

- Automatic Tracking – Detect and track birds at least as well human observers.
- Sampling Protocols – Operate unattended under real-world conditions, continuously tracking different species and densities of birds in real time, through a 360° field-of-view, out to and beyond the perimeter of military bases and the altitudes of most bird strikes.

- Data Streaming – store the numerical data generated for each tracked target locally and stream them reliably over a network to real-time or historical applications.
- Data Integration – Combine tracks from independent radars without overlapping coverages into a common operational picture (COP) that increases situational awareness.
- Data Fusion – Fuse duplicate tracks from independent radars with overlapping coverages in real time into common tracks to increase situational awareness and track continuity.

The demonstration study sites for the IVAR project included: Marine Corps Air Station Cherry Point, NC; Naval Air Station Patuxent River, MD; Naval Air Station Whidbey Island, WA; Elmendorf Air Force Base, AK; Sea-Tac International Airport, WA; Edisto Island, SC; and Accipiter Radar Technologies, Inc., Ontario, Canada.

We developed 31 Performance Metrics to evaluate the five Task Objectives listed above. One Metric, “Tracks Single Birds and Flocks”, was divided into three related metrics, and we added a sixth Task Objective “Additional” with five additional metrics. Of the resultant 38 Performance Metrics, 24 were quantitative and the other 14 were qualitative.

All 38 Performance Criteria were met or exceeded. The results of those demonstrations are summarized below.

Automatic Tracking. First we demonstrated that the radar processor could track synthetic, software-generated targets with known, complex target dynamics. Next, two-person teams of observers visually confirmed as birds more than 1500 targets tracked by the digital avian radars during fall and spring campaigns at four different geographic locations; we employed a thermal imager to confirm targets tracked by eBirdRad at night were birds. We also tracked a remote-controlled helicopter with the radar to check the accuracy of the spatial coordinates the radar processor generates for each target. Finally, we demonstrated the radar could track birds at ranges beyond the perimeter of a very large military airfield, could readily track more than 100 targets simultaneously, and could record in real time a host of parameters for each tracked target.

Sampling Protocols. To illustrate the breadth and depth of the radar’s ability to track targets in realistic operational settings, we demonstrated these systems can track targets continuously, 24/7 for years, through a complete 360° field-of-view, out to a range of at least 11 km (6 nautical miles), and up to an altitude of ~1 km (3000 feet) – the nominal bounds for short-range avian radar systems. We further demonstrated the sampling schedules of these systems can be pre-set or remotely controlled for unattended operations, and that they can detect 50 times more birds than human observers using conventional visual methods. Finally, we demonstrated that the volume of data generated by these systems over these time periods fits onto COTS mass storage devices and can be displayed on maps or graphs to show bird activity patterns in time and space.

Data Streaming. To demonstrate that the detections (plots) and tracks data generated by the radar can be transmitted across local- or wide-area communications networks to where they are needed, we transmitted data generated by an avian radar in Seattle more than 3000 km across the Internet to the ARTI Headquarters in Ontario with no data loss and 100% network uptime. We further demonstrated that these data could be organized into a

database and redistributed to other workstations and applications in real time. We also demonstrated users can configure the radar processor to generate automatic alerts that are transmitted over a variety of media to notify personnel that a predefined event has occurred (e.g., too many birds entering a delineated airspace). Finally, we demonstrated streaming live radar data to personnel in the field to alert them to bird activity as it occurs.

Data Integration and Data Fusion. Data integration and data fusion combine the plots and tracks being streamed from two or more independent radars to expand coverage, increase situational awareness, and extend track continuity. We demonstrated data integration, which displays the tracks from radars with or without overlapping beams in a single common operational picture (COP), by merging tracks from widely-separated radars and showed the time latencies between the two systems were minimal. For data fusion, which combines into common tracks the individual tracks of a target from multiple radars in their area(s) of overlap, we showed that pairs of radars could be synchronized both temporally and spatially, and that the processing time needed to fuse tracks was small – in some cases, 30-times faster than real time.

Additional. We also demonstrated that the cost of operating an avian radar is low relative to the other methods of providing the same spatial and temporal coverage; that the reliability of these systems is high; and that they are already proving their worth in military and civil applications.

Cost Analysis. The cost of acquiring, installing, and operating an avian radar system can vary greatly depending upon the facility's requirements. Based on a 5-year life-cycle, the cumulative cost for a single, integrated, trailer-mounted system that would be optimal for most military facilities is approximately \$450K. An integrated system would provide remote control and remote access for visualizing and analyzing the target track data, and could reduce costs through remote maintenance by the vendor. Other costs would include installation (concrete pad and utilities) and operation and maintenance costs on the order of 10% of the purchase price.

Technology Transfer. The following resources are available to transition avian radar system technology to operational use at military facilities:

- Commercial equivalents of all the products evaluated by the IVAR project are available for purchase or lease and vendor web sites are provide in this Report.
- The Functional Requirements and Performance Specifications for Avian Radar Systems addendum to this Report was developed from the IVAR studies.
- FAA Advisory Circular 150/5220-25 (FAA, 2010) provides guidance and performance specifications for selecting, deploying and operating avian radar systems at civil airports. Much of the FAA guidance and specifications are equally applicable to military airfields; many of the performance specifications are identical to those developed by IVAR.
- Personnel from the Navy, Marine Corps, and Air Force facilities that participated in the IVAR project are available to assist in understanding how avian radar technology might meet the requirements of natural resources management and BASH applications.
- The Air Force has, and the Navy is finalizing, a BASH Program of Record that provides both the policy and funding guidelines for avian radar systems technology.

The results of the IVAR study show that digital avian radars that can provide data with the details and response time of the systems we evaluated are valuable tools to natural resource and BASH managers in monitoring the location and behavior of avian species of interest. These systems are cost-effective and provide information that is not available from other sources or with techniques. We conclude from our study that the avian radars we tested are ready to transition to military users on a wider scale and that this report provides a detailed overview, understanding, and guidance to aid in that transition.

1 INTRODUCTION

1.1 BACKGROUND

Encroachment has made once-rural military facilities islands of habitat diversity surrounded by seas of urbanization. Military bases and ranges have become refugia for birds and other wildlife. Consequently, the military's already significant role as a steward of their environment – in some locations including species with protected status – has increased. Now encroachment is increasing inside the fence line, as facilities take on more and more activities to remain mission-relevant. These trends are straining the ability of natural resource management (NRM) personnel to protect the wildlife at these facilities while ensuring the military can prepare and train for its primary missions. Similarly, Bird Aircraft Strike Hazard (BASH) managers at airfields and training ranges must know the behavior and ecology of resident and migratory birds in order to reduce bird strikes that cause more than \$600M/Yr in damage to U.S. military and civilian aircraft, plus the danger they pose to aircrews and passengers.

The management of resident and migratory birds must also be accomplished while managers operate under a mandate to “do more with less”. Military resource managers need tools that yield better situational awareness, provide a clearer understanding of where and when birds are present, what attracts them to certain locations, and how changes in the natural or manmade environments affect their distribution. Current sampling methods (e.g., visual observations) are slow, non-continuous, not well suited to real-time situational awareness, and expensive, particularly for large facilities. Visual census methods, while effective during daylight, are unreliable from dusk to dawn, when the most bird migration is greatest, and when it is essential to sample at the elevations and ranges of nighttime birds. Similarly, BASH programs need better information suitable for both planning missions and avoiding bird strikes, information based on timely acquisition and processing of data on bird abundance and movement.

Nohara, et al. (2005, 2007) and Herricks and Key (2007) and others have discussed how inexpensive marine radars have been adapted to detect and track birds and other biological targets. Only recently has digital, automatic radar signal processing (i.e., automatic detection and tracking) and Internet connectivity provided the promise of full utility from avian radar systems. Such radars have been developed for, and successfully used by, the Navy for some time, but this use is limited to a few locations. Before digital avian radar systems can be applied systematically to NRM and BASH issues on military lands, demonstrations are needed to document how improvements in the capabilities of avian radar systems meet the needs of users. These demonstrations must to be carried out across different sampling locations and times, monitor varying bird populations, and incorporate site-based radar configurations. Demonstrations under these conditions will validate the benefits that this technology brings to broader military use. Such demonstrations and the reports arising from them will advance user awareness of the tool's availability and contribute the integration of new types of information on bird population dynamics. Such contributions will improve monitoring methods and provide better support for military flight operations.

Section 2.3 outlines the user-based-requirements analysis that led to the development of the enhanced BirdRad, or eBirdRad, avian radar system and subsequently to the IVAR Project. **Table 1-1** maps those general statements of requirements against IVAR Project Tasks. The

Tasks/Objectives in **Table 1-1** were divided into two groups and a separate Demonstration Plan was prepared for each group: Automated Tracking and Sampling Protocols were the subjects of the first IVAR demonstration plan, and Data Streaming and Data Fusion & Integration were the subjects of the second IVAR demonstration plan.

Each Project Task listed in **Table 1-1** includes a specific demonstration objective that represents a subset or element of the overall project objective as described in Section 1.2. These specific objectives, along with the corresponding user benefits and capability improvements to which they are directed, form the context from which Performance Criteria are derived and assessed as described in Section 3.

This report describes a performance assessment process that was used to demonstrate the ability of digital avian radar systems to meet user needs. The demonstration objectives, performance criteria and their respective performance metrics, and the methods for assessing the performance achieved during the demonstrations are consistent with the results of an analysis of end-user requirements (see Section 2.3) for new technologies that are appropriate for sampling bird populations to sustain NRM and BASH missions.

1.2 OBJECTIVE OF THE DEMONSTRATION

Based on the user requirements developed by SSC-Pacific (Section 2.3), the eBirdRad project developed a digital avian radar system and then successfully field-tested it to demonstrate its ability to automatically detect and track birds in real time (Section 2.4.3). The objective of the IVAR project was to further demonstrate that this technology could be scaled and integrated into operational field environments so as to provide DOD's natural resources and bird-strike avoidance programs with more accurate, timely, readily-accessible, and actionable data on bird activity, both within and beyond the fence line of most military installations.

To accomplish this goal, we developed the following six project objectives for the digital avian radar systems specifically evaluated by the IVAR project.

- **Automatic Tracking.** Demonstrate that these systems can automatically detect and track birds as well as, or better than, a human observing the same scene on an analog radar display and be able to do so in real time.
- **Sampling Protocols.** Demonstrate that these systems can be operated automatically, remotely, or manually to detect daily and seasonal bird activity at different geographic locations.
- **Data Streaming.** Demonstrate that the target track data these systems generate can be transmitted in real time across both local- and wide-area networks for remote storage, analysis, visualization, and redistribution.
- **Data Integration.** Demonstrate increased situational awareness for the users at a facility by combining track data from multiple radars into a common operational picture.
- **Data Fusion.** Demonstrate increased situational awareness and track continuity by fusing tracks from multiple radars into common tracks.
- **Additional.** Demonstrate that these avian radar systems are safe and relatively easy to operate by personnel with no prior radar experience and minimal training.

A seventh objective, the **Functional Requirements and Performance Specifications**, is an additional program objective that is included as part of the discussion with respect to technology

transfer to guide future potential users in the process of evaluating, acquiring and operating digital avian radar systems.

In **Table 1-1** we expand upon these six objectives and provide more detailed descriptions, projected user and operational benefits, and user capability improvements that should accrue from this technology. We further subdivide, in **Table 3-1**, the first five objectives and the “Additional” performance objective into a series of performance metrics and associated criteria designed to demonstrate various aspects of each. The inclusion of an objective on Functional Requirements and Specifications is included in Table 1-1 for information purposes. In Section 4.7 we describe tests we designed to demonstrate these objectives, and in Section 5.6 we present the specifics of each demonstration, together with the results of and conclusions from those analyses.

Table 1-1. Mapping between IVAR Project Tasks and User Benefits and Capabilities.

IVAR TASK/ OBJECTIVE	USER /OPERATIONAL BENEFITS	USER CAPABILITIES
<p>AUTOMATIC TRACKING</p> <p><i>Objective: to validate through demonstration the eBirdRad digital avian radar’s fundamental ability to automatically detect and track birds and support the development of new user data products that replace manual methods. Distribute preliminary data products to users for feedback.</i></p>	<ul style="list-style-type: none"> • Improve understanding of radar technology, specifically coverage and capability of eBirdRad • Enhance user acceptance of technology through demonstration of radar applications to NRM and BASH tasks • Meet users’ needs for expanded wildlife observations (24/7 operations over seasonal time scales) • Demonstration of performance under a variety of environmental conditions, terrain and against a variety of targets • Demonstrate integration of radar into existing wildlife management and BASH programs 	<ul style="list-style-type: none"> • Provide continuous and automatic operation of radar to improve the situational awareness of bird dynamics on and around the airfield • Supplement visual monitoring methods with 24/7 data • Provide monitoring of bird movements at night where visual counts are ineffective • Provide monitoring of bird movement beyond airfield boundaries • Provide individual bird and flock tracks (lat, long, speed, heading, intensity, and height versus time) • Provide automated alerts of bird hazards for military airfields • Provide recording and playback of radar data to support historical analyses and investigations

Table 1-1 (cont.).

IVAR TASK/ OBJECTIVE	USER /OPERATIONAL BENEFITS	USER CAPABILITIES
<p>SAMPLING PROTOCOLS</p> <p><i>Objective: to develop sampling protocols that meet quality objectives for measuring daily and seasonal bird activity; demonstrate and evaluate the use of these protocols at multiple sites.</i></p>	<ul style="list-style-type: none"> • Demonstration of the configuration of avian radars in support of site sampling objectives • Demonstration of the development of data products suited to site applications and operational requirements • Demonstrate how radar data are used to develop better wildlife management plans • Development of user confidence in providing better characterization of sensor performance in NRM and BASH applications 	<ul style="list-style-type: none"> • Provide a source of diurnal, daily, and seasonal (migration) bird monitoring data for sites • Provide procedures for data collection and analysis • Provide means for automatic scheduling of radar monitoring • Provide means for remote control of radar monitoring • Provide procedures to display data in formats that are accessible to all users • Provide protocols for integration of dual-use applications • Provide procedures for the automatic generation of statistical bird dynamics, patterns of movement, and other data products identified by users
<p>DATA STREAMING</p> <p><i>Objective: to demonstrate the streaming of bird track data in real time across a network for multiple sites; demonstrate compliance with quality assurance objectives; provide support for immediate (e.g., alarms, real-time tracks) and historical (e.g., activity pattern) wildlife management, analysis, visualization, and data sharing.</i></p>	<ul style="list-style-type: none"> • Demonstration of the value of networks in meeting functional requirements of users • Demonstration of the site specific development of network capabilities and the streaming of specified data to users • Demonstration of the utility and quality of streamed data in immediate and historical data sharing • Demonstration of the integration of radar data on military networks and systems • Demonstration of streamed data product integration in NRM and BASH programs at sites. 	<ul style="list-style-type: none"> • Provide users with centralized data management system for radar data • Provide users with centralized access to radar data to provide alarms and real time tracks • Provide users with centralized access to radar data to provide data for historical analysis • Provide a capability for database queries from many locations • Provide the capability for integration into third party information systems

Table 1-1 (cont.).

IVAR TASK/ OBJECTIVE	USER /OPERATIONAL BENEFITS	USER CAPABILITIES
<p>DATA INTEGRATION</p> <p><i>Objective: to demonstrate improved bird situational awareness through the integration of radar tracks from multiple radars</i></p>	<ul style="list-style-type: none"> • Demonstration of the improvement of situational awareness by providing combined views of multiple radar data sources • Demonstration of the enhancement of management capabilities by integrating tracks into a single display • Demonstrate a reduction of monitoring cost by allowing NRM and BASH personnel to do more with less • Demonstrate the reduction of system costs by providing centralized management • Enhanced information sharing and cooperation among neighboring military bases • Enhanced integration of bird movement data into airport safety management and information systems 	<ul style="list-style-type: none"> • Provide improved situational awareness by providing a common operating picture when multiple radars are deployed • Provide integrated data from sensors to support local, regional and national avian hazard advisory systems • Provide enhanced data products to networks for streaming to multiple locations • Enhance procedures used by operators in analyzing avian tracks and in determining the dynamics of bird movements • Provide the capability for the deployment of multiple radars that increase coverage around and beyond the airfield • Provide the capability for deployment of avian radars at many locations including along low-level, military training routes • Provide support for multiple remote users, each with customizable, real-time avian target displays and customizable automated alerts
<p>DATA FUSION</p> <p><i>Objective: to demonstrate improved bird situational awareness through fusion (the combination of track data from multiple radars with overlapping coverage to reduce duplicate tracks and increase track continuity)</i></p>	<ul style="list-style-type: none"> • Demonstration of the improvement of situational awareness by preserving track continuity as birds move from the coverage area of one radar to another. • Demonstration of the improvement of situational awareness by more accurately reflecting bird abundance when the coverage of two radars overlap through automatic duplicate track removal. 	<ul style="list-style-type: none"> • Provide improved situational awareness through the accurate depiction of bird movements across larger coverage volumes than a single radar can provide. • Enhance procedures used by operators in analyzing avian tracks and in determining the dynamics of bird movements

Table 1-1 (cont.).

IVAR TASK/ OBJECTIVE	USER /OPERATIONAL BENEFITS	USER CAPABILITIES
<p>FUNCTIONAL REQUIREMENTS & SPECIFICATIONS</p> <p><i>Objective: to develop a set of functional requirements that meet user requirements for the operation of avian radars; develop specifications for users to consider when purchasing or using avian radar systems.</i></p>	<ul style="list-style-type: none"> • Documentation of radar functional requirements in a format that allows specification of requirements to meet user needs • Identification of reliable information and best practices that can be adapted to meet specific user needs • Documentation to support improved communication between radar users • Documentation to provide support for selection of radar system components and characteristics to meet specific needs. 	<ul style="list-style-type: none"> • Provide support for cost/benefit analyses in support of users decisions to deploy radar systems • Assist users in comparing competing systems • Assist users in deploying avian radar systems to meet site specific requirements • Assist users in understanding avian radar in relation to existing NRM and BASH programs
<p>ADDITIONAL</p> <p><i>Objective: to demonstrate these avian radar systems are safe, cost-effective and relatively easy to operate for NRM and BASH personnel.</i></p>	<ul style="list-style-type: none"> • Outline procedures to ensure to minimize hazards to fuels, ordnance, and personnel from the operation of the radars. • Show from operational records these radar systems are reliable. • Show from training records these radars can be operated by personnel with no prior radar experience and minimal training 	<ul style="list-style-type: none"> • Provide assurance to users that the procedures for operating this class of radar systems at military facilities are well known and documented. • Assure users they will be able to operate these radars, and process the data they generate, without lengthy and expensive training. • Provide evidence these radar systems are reliable and require relatively low maintenance.

The IVAR project proposed to conduct a series of field demonstrations to determine if the radar systems it is evaluating meet or exceed these objectives. These field studies were conducted at different geographic locations, at different times of the year, and under a range of real-world operational conditions. In nearly all instances, the avian radars systems that were evaluated had been operating at these locations prior to the tests conducted by the IVAR team and will continue to operate at those locations after the IVAR project is complete.

1.3 REGULATORY DRIVERS

The basis for the statement in Section 1.1 that “military bases and ranges have become refugia for birds and other wildlife” lies in the fact that the DoD, which ranks only fifth among Federal landholders in terms of the number acres it controls, hosts three times the density of species listed as threatened or endangered under the Endangered Species Act (ESA) of any other federal landholder (Stein et al., 2008). The Navy alone has known or potential endangered species of birds on over 90% of its ranges and 30% of the endangered bird species found on all DoD lands occur on Navy ranges.

These statistics underscore the importance of sound stewardship of natural resources at DoD installations and why, in turn, NRM has become an identifiable function at all levels of the military command structure. DoD instructions and policies make it clear that decision makers, operators, planners, and land managers must take conscious and active steps to properly balance

environmental stewardship with mission readiness; otherwise, the availability of the land, sea, and air space necessary to provide for realistic testing and training opportunities could be at risk.

Ecosystem management principles are employed as the basis for planning, training, and operations at DoD installations. This conservation approach is accomplished through the development and implementation of installation Integrated Natural Resources Management Plans (INRMPs), as required by the Sikes Act Improvement Act of 1997 (16 U.S.C. 670a et seq.) for all DoD installations with significant natural resources. These INRMPs are intended primarily to guide installation commanders and their staff in the management of natural resources to ensure that there is “no net loss in the capability of military installation lands to support the military mission of the installation”. Military natural resources managers must also provide the metrics necessary to measure conservation program successes and impacts on the installation mission. The development and implementation of INRMPs also help DoD meet specific conservation requirements mandated by the Endangered Species Act, Migratory Bird Treaty Act, Clean Water Act, National Environmental Policy Act, and a host of Executive Orders. The importance of these requirements is further amplified in a variety of DoD Directives (e.g., DoD Directive 4715.3, “Environmental Conservation Program” and DoD Directive 3200.15, “Sustainment of Ranges and Operating Areas (OPAREAs)”) and programs (e.g., DoD Partners in Flight).

The acquisition of baseline resource data on which to base INRMPs is essential to ensure the DoD’s regulatory requirements are met, that there are no net losses to military capabilities, and to generate the metrics necessary to measure conservation program impacts on military missions. Significant resources are invested annually to survey and monitor diverse flora and fauna populations and habitat types to accomplish these tasks.

One of the more crucial components of the DoD’s surveying and monitoring requirements is to track changes in bird populations and to identify factors governing the distribution and abundance of migratory birds on military lands and training routes. These monitoring activities are necessary to comply with the Migratory Bird Treaty Act (16 U.S.C. 703-712), the Memorandum of Understanding required by Executive Order 13186 (“Responsibilities of Federal Agencies to Protect Migratory Birds”), and the Migratory Bird Rule governing the incidental take of migratory birds as required by Section 315 of the FY 2003 Defense Authorization Act. The Migratory Bird Rule is the most binding requirement in that it mandates that DoD minimize, mitigate, and monitor impacts to bird populations in order to accommodate incidental takes of birds during mission operations. It is therefore essential that DoD develop and maintain the capabilities necessary to acquire bird migration data necessary to provide the “incidental take” provisions authorized by the Rule. Otherwise DoD testing and training operations and new construction could be impeded with adverse impacts on military readiness.

Chapter 7 of 16 United States Code makes it unlawful at any time, by any means or in any manner, to pursue, hunt, take, capture, kill, attempt to take, capture, or kill, any such bird or any part, nest, or egg thereof, included in the terms of the conventions between the United States and Great Britain for the protection of migratory birds concluded August 16, 1916 (39 Stat. 1702), the United States and the United Mexican States for the protection of migratory birds and game mammals concluded February 7, 1936, the United States and the Government of Japan for the protection of migratory birds and birds in danger of extinction, and their environment concluded March 4, 1972, and the convention between the United States and the Union of Soviet Socialist Republics for the conservation of migratory birds and their environments concluded November 19, 1976.

More recent drivers for increased monitoring of bird populations at DoD facilities include:

- February 2007 report of the North American Bird Conservation Initiative (NABCI) titled “Opportunities for Improving Avian Monitoring”
- Efforts to prepare a DoD Coordinated Monitoring Plan, in which radar technologies are anticipated to figure prominently (Chris Eberly, personal communication)
- Guidelines that are being prepared for the siting of wind farm facilities on DoD lands.

While there are no external regulatory drivers requiring DoD to implement and operate BASH programs, the following directives establish the policy and procedures for the United States military programs:

Navy/Marine Corps:

- On 7 July 2011 the Commander Navy Installations Command (CNIC) signed the Navy BASH instruction, CNICINST 3700.
- NAVFAC P-73 Manual, *Real Estate Procedural Manual* (Provides guidelines to create a BASH Plan).
- OPNAVINST 3750, *Naval Aviation Safety Program* (Requires all aircraft/wildlife strike events to be reported to the Naval Safety Center).

Air Force

- Pamphlet 91-212 - Bird/Wildlife Aircraft Strike Hazard Management Techniques

Army

- The U.S. Army does not have a BASH program.

2 TECHNOLOGY/METHODOLOGY DESCRIPTION

2.1 TECHNOLOGY/METHODOLOGY OVERVIEW

There have been dramatic and rapid developments in avian radar technologies during the past decade. Avian radars have gone from analog systems without the capability of automatically recording data to systems with digital signal processing and the capacity to automatically save data to hard drives. **Figure 2-1** provides a chronological overview of the development of avian radar systems.

Radar has been used to study birds since the 1940s, shortly after the technology was developed (Lack, & Varley, 1945). More recently, researchers began using Doppler weather radars in the 1990s to study bird movement on regional and continental scales (100 km and beyond). During this same period, researchers assessed how airport surveillance radars, which can also detect birds, might fill in the medium-range scales (10-100 km) of bird movements. In both of these cases, however, the radars used were designed for some other application (e.g., weather prediction, air traffic control), they were not necessarily located where the birds of interest were, and they were too costly to purchase, integrate, and dedicate to studying birds.

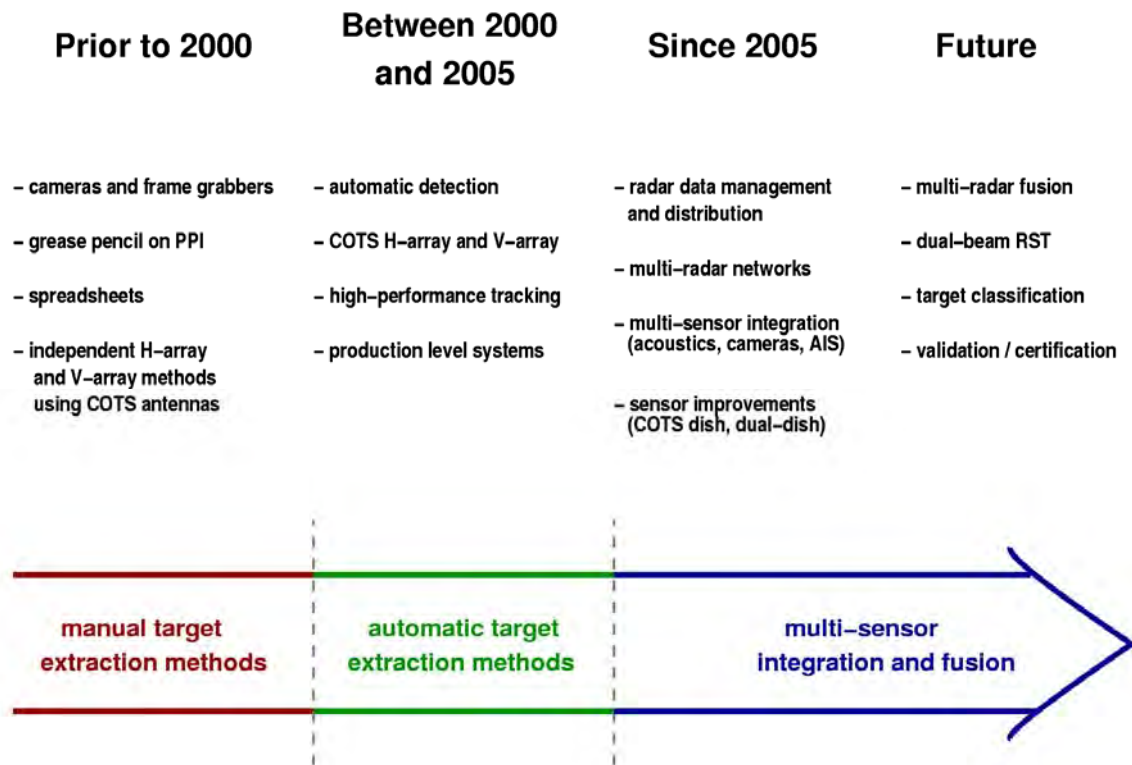

Figure 2-1. Chronology of avian radar developments. [Source: Nohara, et al., 2007]

Beginning in the 1970s, researchers have adapted analog marine radars in order to study bird movements. Human operators developed procedures to manually identify bird echoes on the

radar screen and follow their movements from scan to scan, estimating direction, speed, and their number. These manual radar signal processing methods, while effective in improving bird detection, especially at night when visual methods are highly limited, are time consuming and prone to bias as operators select radar echoes to track. With improvements in digital signal processing, computing, database management and networking technologies, digital avian radars are now commercially available. The modern digital radars have overcome the limitations of their predecessor analog radars through the implementation of detection and tracking algorithms that automatically process bird target echoes to produce bird track data that include the target's position, heading, and speed estimates versus time on geographically accurate screen backgrounds. An overview of the development of avian radars (both of the analog and digital variety) is provided in Nohara, et al. (2007). Avian radars systems available commercially and employing small, relatively inexpensive X- or S-band marine radars are also described by Herricks and Key (2007). Ruth (2007) provides a summary of the application of avian radar for monitoring birds and the US Geological Survey (USGS) in Fort Collins, Colorado provides on their web site (http://www.fort.usgs.gov/Radar/Bib_Marine.asp) references/links to a number of research papers on this topic.

The U.S. Navy, as described in Section 2.4 below, has been a leader in the development of avian radar systems (both analog and digital), and recently the Federal Aviation Administration (FAA) has undertaken the performance assessment of avian radars at civil airports. The Navy has also been responsible for gathering requirements from the user community (see Section 2.3), which has driven the development of new radar features (such as automatic tracking, data streaming, integration and fusion) now available in some commercial, digital avian radars.

2.2 DOD AND FAA AVIAN RADAR DEVELOPMENT

The U.S. Air Force and the Federal Aviation Administration developed an avian radar through the Dual Use Science & Technology (DUST) Program (Herricks, et al., 2005). This radar used a millimeter wavelength radar to address ranges to 6 km (3 nmi) and altitudes to 1 km (3000 ft). Although prototypes of this radar were tested at Dallas-Fort Worth Airport (DFW) and the Fermi National Accelerator Laboratory, no commercial development of this avian radar type has occurred.

The primary commercial development, and virtually all of the remaining DoD efforts use microwave radar (3 cm and 10 cm wavelengths). The U.S. Air Force (USAF) is using avian radars at several locations that employ a design initially developed by Geo-Marine, Inc. and later modified by DeTect, Inc. This radar system uses horizontally rotating S-band marine radar and one or more vertically spinning X-band radars. Both of these radars are outfitted with an array antenna with a nominal 20° ($\pm 10^\circ$ from horizontal) coverage.

The Defense Department's Legacy Program Office conducted a competitive selection process and chose Clemson University to develop a near-range avian radar system known as BirdRad (Gauthreaux, 1999). The objective of the BirdRad project was to sample bird populations in the 0-11 km (0-6 nmi), a range that was not adequately covered by other radar systems such as the WSR-88D. A specific goal was to sample at dusk and dawn when birds might be arriving at or departing from military lands on their stopovers during migration. The Legacy Program Office was also aware of the potential dual-use of avian radar systems for both NRM and BASH applications.

The original BirdRad system was designed to be an inexpensive, mobile avian radar. It included low-cost commercial off-the-shelf COTS marine radar (Furuno 2155BB) outfitted with a parabolic dish antenna (4° beam width for better altitude resolution) and a desktop PC for displaying and capturing the radar images in graphic files. Five BirdRad systems were built by the Clemson University Radar Ornithology Lab (CUROL) and deployed at three Navy and one Marine Corps air stations, and one Air Force base.

Shortly after the first BirdRad units were deployed, the NRM and BASH personnel who were the end-users of these systems - as opposed to radar engineers or ornithologists who developed this technology - began requesting enhancements to these systems. Those requested enhancements included:

- Removing the excessive ground clutter that made distinguishing the targets difficult;
- Tracking and recording the bird movements automatically;
- Remotely controlling and scheduling the radar operation (for example, for dawn and dusk sampling); and
- Displaying the bird tracks on facility maps and aerial photographs in ways that would be useful to relate bird activity to known landmarks and the underlying terrain features.

In 2002, the Naval Facilities Engineering Command (NAVFAC) tasked the Space and Naval Warfare Systems Center in San Diego, California (SSC-SD¹) to undertake a project to investigate whether the requested enhancements to BirdRad were technically feasible and affordable. The SSC-SD team, which included its contractor, Computer Sciences Corporation (CSC), began by conducting an analysis of the requirements of NRM and BASH personnel for collecting bird activity data, with an eye to understanding how radar technology might assist in those efforts. Based on those analyses, researchers at SSC-SD proposed modifying the design of the BirdRad system by replacing the analog signal processor that came with the marine radar with a digital radar processor and sophisticated digital detection and tracking software – capabilities that previously could only be found in expensive military surveillance and tracking radars. The SSC-SD team concluded that recent advances in COTS computing technologies might make these capabilities affordable for avian radar systems. After a competitive procurement, CSC subcontracted with Sicom Systems Ltd. to adapt its MT-Tracker software (now included and branded under the Accipiter® name) to track birds. The resultant enhanced BirdRad, or eBirdRad, system was first deployed in 2004.

In 2005, the Federal Aviation Administration Research and Development Program (AAR 411) initiated a comprehensive effort to assess the performance of avian radars and radar support systems that had recently appeared in the marketplace from a few vendors. This effort resulted in the deployment of avian radars in 2006 and the initiation of a comprehensive performance assessment program at civil airports, with the purpose of evaluating radar technologies and the supporting data management and control systems. The University of Illinois Center of Excellence in Airport Technology (CEAT) selected the Accipiter® avian radar systems for initial deployment and assessment.

The FAA's deployment and performance assessment of the Accipiter® AR-1 and AR-2 radars at several civil airports was complementary to the ongoing SSC-SD efforts. As part of that effort, the FAA supported a joint deployment of an Accipiter® AR-1 and an eBirdRad at the Naval Air

¹ Now known as the Space and Naval Warfare Systems Center Pacific (SSC Pacific)

Station Whidbey Island (NASWI), while also providing advanced demonstrations of remote operation, data streaming, data management, and operational costs and reliability.

In 2006, SSC-SD and a team of investigators from government, industry, and academia submitted a proposal to the ESTCP to demonstrate and validate the eBirdRad technology under real-world operational conditions; that proposal led to the current Integration and Validation of Avian Radar (IVAR) project. The intent of the IVAR project is to demonstrate and validate under real-world operating conditions the capabilities found in eBirdRad that users demanded. These demonstrations, once successfully carried out, will lead to significant improvements in the capability of NRM and BASH managers to detect, track, quantify and monitor bird movements on and over military lands.

2.3 USER/IVAR PROJECT REQUIREMENTS

In 2003 a team of investigators from SSC-SD prepared a detailed review of the user-requirements analysis that led to the development of the eBirdRad system and formed the basis for the demonstrations and validations of the current IVAR Project. Some of these requirements derived from the original BirdRad project, funded by the DoD Legacy Program Office in 2000 to Dr. Sidney Gauthreaux at the Clemson University Radar Ornithology Laboratory. These initial requirements included:

- Detect birds through an azimuth of 360° over a range of 0-11 km (0-6 nmi).
- Make it possible to estimate the target's height as well as range and azimuth
- Be mobile; i.e., so the unit could be moved within and between facilities
- Relatively low cost

The other set of basic user requirements for an avian radar system followed from the fielding of the first BirdRad units in December 2001. This list of requested enhancements included:

- Removing ground clutter
- Automatic detection and tracking of biological targets
- Automatic capture of track data
- Automatic/remote operation of the radar
- Developing a sampling management software to control the collection of data
- Recording bird observation data into a database
- Displaying tracks in a GIS format (i.e., overlay tracks on a map)
- Ruggedizing the current system

Table 1-1 maps summaries of these user requirements against the seven major groupings of IVAR project tasks. This mapping is valuable because it summarizes the specific capability improvements that led to the performance objectives summarized in **Table 3-1** and detailed in Section 5.6. Furthermore, it shows the expected contribution to the overall objectives associated with each demonstration/validation step identified by the IVAR project.

2.4 TECHNOLOGY/METHODOLOGY DEVELOPMENT

Nohara et al. (2005, 2007) and **Figure 2-1** summarize the development of avian radar technology over the past several decades. This section outlines the sequence of technological developments within that larger context that led to scope and makeup of the IVAR project.

It is important to note that avian radars, unlike military radars, rely heavily on COTS technologies for their development. This fact put radar sensors into the hands of researchers and stakeholders long before digital processing and computing technologies became available to provide automation. As a result, researchers have used marine radars (that one can buy from any marine electronics store) for decades to study birds.

It was apparent soon after the introduction of radar technology in the 1940s that noncoherent radars such as X-band and S-band marine radars are sensitive enough to image and display radar echoes from birds. Hence, the physics associated with the ability of marine radars to “see” birds is well understood and on a firm foundation. Environmental consultants, biologists, and ornithologists have successfully used these sensors with a suite of manual target extraction methods to study bird movements in a variety of locations. Fishermen have used their marine radars (intended for navigation) to find birds hovering above water, with the hope that they are feeding on fish below. Many marine radars in fact have a “bird” setting on the setup and installation menu!

However, the high-speed and affordable digital computing technology that is necessary for automated real-time target extraction methods (i.e., detection and tracking) has been unavailable until recently (see Figure 2-1). An essential element of the IVAR project is the evaluation of this automation; including, automatic detection and tracking, automatic scheduling and remote control, automatic streaming of numerical target data over networks with real-time organization into and retrieval from relational databases, and automatic integration and fusion of radar target data from multiple radars. The technological performance criteria defined in Section 3 relate to these radar technology elements.

Because digital avian radars are relatively new, there are no “industry standards” either for testing or for using these systems. One contribution from the IVAR project will be a set of functional requirements and performance specifications developed for users to consider when purchasing or using avian radar systems. We will include in these requirements characteristics of the targets, location and configuration of radar sensors, characteristics of automation, and the fusion and integration of information from multiple sensors. The protocols we prepare will also consider use and application, including elements such as ease of use, training, adaptability of data and information products for specific applications, and speed of information transfer to users. Our goal is to provide draft performance specifications that can serve as the starting point for specifications and guidelines to assist potential end-users in judging capabilities of available avian radar systems.

2.4.1 Operational Definition of “Real Time”

The term “real time” is used throughout this document, as it often is in discussions of modern avian radar systems. Intuitively, we think of real time as meaning “as it happens.” Formal definitions² expand upon what “it” means by adding the concept of the operational deadline

² <http://en.wikipedia.org/wiki/Real-time> [accessed 25 Apr 2011]

between an event and a response to that event. In other words, what constitutes real time depends upon how an event and the response to that event are defined.

In the context of avian radars, if the event is simply defined as transmitting a burst of energy from the radar transceiver, and the response is defined as detecting the return of some of that energy from a target, then real time is measured in milliseconds. If the response is defined as detecting movement by a target such as a bird, then real time would be on the order of several seconds – the time it takes to detect and compare the position of a target in two successive scans of the radar. This definition of real time may have a longer timeline if the event-response includes the time it takes to first acquire the target as it moves into the radar beam, which may require 3-4 scans to form successive plots into a confirmed track. And finally, real time could be on the order of tens of seconds in a “sense & alert” scenario, where the response is to generate an alert when a confirmed target is headed toward a predefined space, such as the approach corridor at an airfield or a waste water containment pond.

Unless otherwise stated, “real time” is used in this and other IVAR documents to mean that the processor can continuously track the movements of all confirmed targets within the sampling volume of the radar beam, including computing and recording all parametric data for each of the targets, in the time it takes for a single scan of the radar – nominally 2.5 seconds for the avian radar systems used in the IVAR studies.

2.4.2 BirdRad - Analog Radars with Manual Tracking

BirdRad is an analog avian radar system that was developed by Dr. Gauthreaux at Clemson University with funding from the DOD Legacy Program Office (Gauthreaux, 1999). The Furuno 2155BB radar sensor transceiver (RST) and parabolic dish antenna used for BirdRad were mounted on a wheeled cart and connected to a support trailer by a 50 ft umbilical cable, as illustrated in **Figure 2-2**. The cable provides power to and control of the RST and carries the received analog radar signals to the processing electronics inside the trailer. The output from a global positioning system (GPS) unit mounted on the roof of the BirdRad trailer is also fed into the processing electronics of the FR-2155BB. The output from the “black box” processing electronics of the FR-2155BB is connected to a standard analog plan position indicator (PPI) display. The position of the radar is at the center of the display, the degrees of azimuth are displayed around the perimeter, and the range rings are displayed outward from the center (see Figure 2-3) – in this case, at 450 m (0.25 nmi) increments. While the output signal from the 2155BB can be displayed directly on a CRT or computer monitor, in the BirdRad configuration the output first passes through a video capture board in a desktop PC and then to the computer monitor. This allows the operator to view the PPI display on the computer monitor and, through the use of a companion software product, to save static images (screen captures) of the PPI display as graphic files on the computer’s hard disk.

BirdRad System Configuration

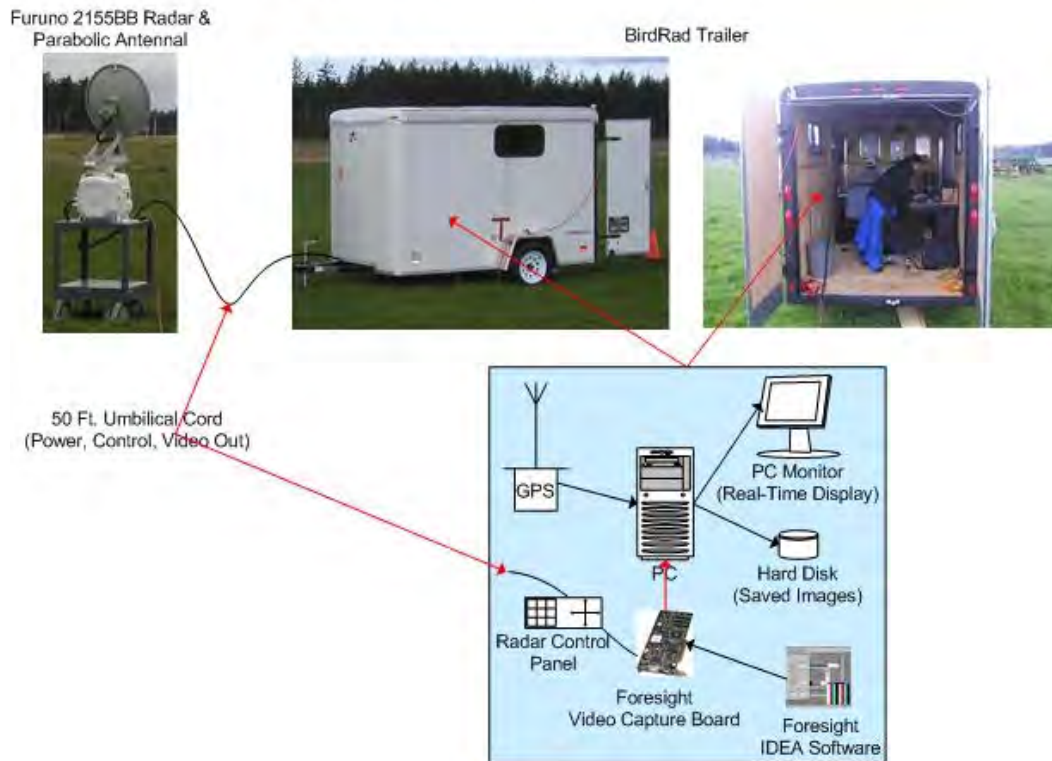

Figure 2-2. Configuration of BirdRad system.

A useful feature of the FR-2155BB, and another reason for choosing this particular model, is the user-selectable “True Trails” display. In this mode, the radar displays returns from the current scan in yellow; it displays returns from the previous 15 scans in graduated shades of blue (see Figure 2-3). The current returns (i.e., the yellow) overwrite any prior returns (i.e., the blue) on the screen. Thus, the radar displays stationary targets such as buildings and trees in yellow, the current position of moving targets in yellow, and the previous positions of moving targets in dimmer shades of blue. Figure 2-3 displays this effect seen quite clearly, with the target that is east-northeast of the radar, moving in an east-southeast direction. The faint red circle (added after the image was captured) highlights the current position (yellow blob) of the target (in this case, a flock of Mallards), while a straight line of blue blobs denoting returns from the target’s prior positions trails off behind it. Other, shorter target trails (faint red circles) can also be seen in this image. [Note: This image was recorded at NAS Whidbey Island (NASWI), WA. The two sets of faint parallel blue lines were also added after the image was captured to delineate the positions of the NASWI runways.]

The target trails display in Figure 2-3 is not true tracking: The radar processor has no information to connect one blob on the screen to another. The processor is simply displaying a color-coded history of radar returns that provides the human observer with the visual cues to “connect-the-blobs”, as it were, and more readily recognize moving targets.

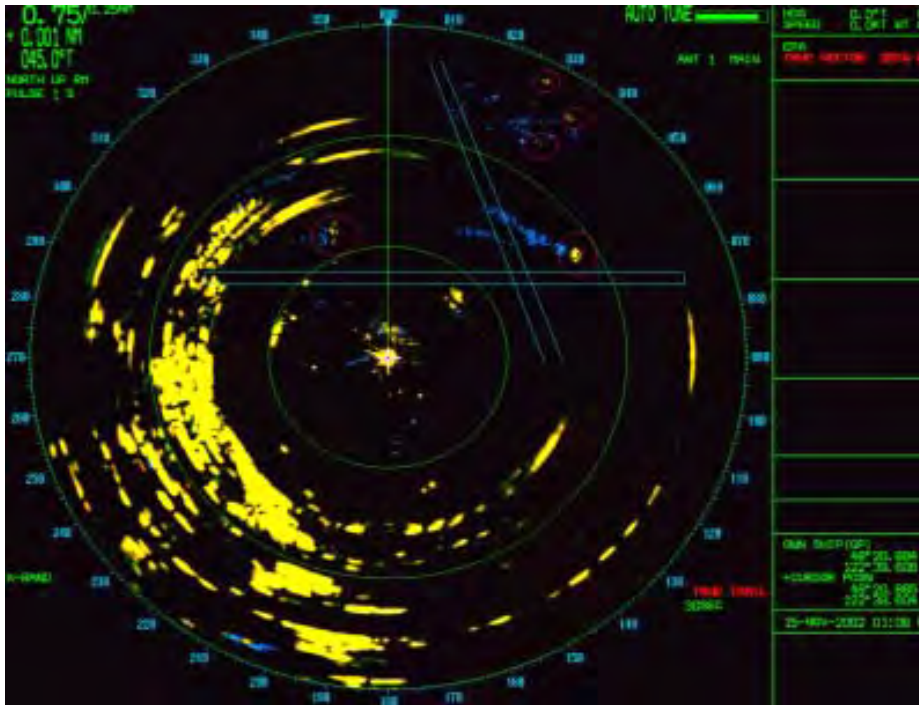

Figure 2-3. PPI display from the BirdRad avian radar system, NAS Whidbey Island, 25 March 2002. [Note: The red circles and two sets of parallel blue lines were added after this image was captured)

To extract quantitative data about a target from this type of analog display, the operator first captures a graphic image of the screen and then uses a ruler to manually measure the target's bearing and range relative to the radar, its heading, speed (using track length and the rotation rate of the radar), altitude above ground level (using range and the angle of antenna above the horizontal), size of the radar returns (blobs), and other parameters.

Figure 2-3 also illustrates a number of the technical problems with analog avian radars. First, the large areas of yellow to the left of the display are echoes from ground clutter – radar returns from stationary objects like buildings, trees, and the ground itself (received through side lobes off the main radar beam in this case because the dish antenna was elevated). It is difficult for the operator to detect targets moving above or near this ground clutter: The target's current position is indistinguishable from the mass of yellow, and the blue trail representing the target's prior positions is overwritten by the yellow of the current returns from the ground clutter. Second, the process of extracting target data from these images is slow, tedious, and largely manual; nor can it be done in real time – a major limitation for air-safety applications. Third, it is difficult to relate the target's position on the display to the position of buildings and land features – and thus the need to draw in the runways when post-processing the image in Figure 2-3. And finally, the radar cannot be operated, and the data from the radar cannot be collected, automatically or remotely.³

³ It is possible to convert the VGA signal from the FR-2155BB to a video format such as NTSC and stream the video to a VHS or similar recorder, but the resultant loss in image quality makes detection and tracking of targets even more difficult.

2.4.3 eBirdRad – Digital Radars with Automatic Tracking

SSC-SD used funding from NAVFAC to develop the eBirdRad avian radar system to address the technical issues raised by the end-users. eBirdRad uses essentially the same Furuno 2155BB RST and dish antenna as illustrated in **Figure 2-2** for the BirdRad system⁴: The difference is in its digital processing architecture, as illustrated in the lower portion of **Figure 2-7**. The RST's radio frequency received-echo signal is demodulated down to video frequencies and is referred to herein as the *raw received video signal* (i.e., before the Furuno analog video signal processing is applied). This raw analog video signal is fed to an Accipiter® Digital Radar Processor (DRP) that is hosted on a PC-type computer. The DRP includes a radar interface board that interfaces to the RST and digitizes the RST's raw video signal. The DRP includes automatic detection and tracking software to process the digitized raw data received from each radar scan, along with a graphical user interface (GUI) and display. The DRP has the ability to store both the raw digital data and the target data (i.e., detections and tracks extracted from the raw digital data) locally, as well as real-time interfaces for streaming the target data efficiently over TCP/IP networks to an Accipiter® Radar Data Server (RDS).

An eBirdRad avian radar system with an X-band dish antenna is shown in Figure 2-4 (exterior) and Figure 2-5 (interior). The DRP (the black cabinet with the computer mouse sitting on top of it in Figure 2-5) performs radar signal processing functions such as scan-conversion, adaptive clutter-map processing to remove ground and weather clutter, sector blanking, constant false alarm rate (CFAR) detection, and numerous operator displays, one of which is illustrated in Figure 2-6. In addition, the DRP has a digital bird trails mode that retains current and past bird echoes and presents them as a fading trail as in the BirdRad system, in order to make bird radar signatures easily visible to an operator. A implementation of the Multiple Hypothesis Testing/Interacting Multiple Model (MHT/IMM) algorithm, the most advanced tracking algorithm known to radar engineers [Blackman, 2004], provides automated tracking, with a track capacity of 1000 tracks.

Nohara et al. (2005) first proposed a practical design for a digital avian radar network. The core elements of their proposed design included: 1) A processor that digitized the radar returns and extracted the target track information from them and then 2) streamed the target track data across a network to a local or remote data server that would 3) both store and manage the data for further analysis and stream the data, in near real time, to workstations for visualization or processing by third-party applications. **Figure 2-7** is a diagram on the components of a digital avian radar; **Figure 2-8** illustrates how those components have been deployed at several IVAR study locations in a network architecture that conforms to the design proposed by Nohara et al (2005).

The raw digital data recorded by the DRP support off-line playback, reprocessing, and analysis. The RDS not only receives target data in real time from the DRP (or multiple DRPs in the case of a radar network) but also simultaneously streams the target data to a remote Accipiter® client such as a TrackViewer® Workstation (TVW), or to third party applications (such as a Geographic Information System [GIS], Google Earth, or other Web Services) as shown in **Figure 2-7**.

⁴ Furuno no longer manufactures the Model 2155BB. eBirdRad systems currently in production and the AR-1 and AR-2 used at several IVAR sites employ newer-model radars with the equivalent capabilities, such as the Furuno Models 8252, 2127 or 2157.



Figure 2-4. eBirdRad trailer at MCAS Cherry Point



Figure 2-5. Interior view of the eBirdRad unit at NAS Patuxent River.



Figure 2-6. Typical display of eBirdRad avian radar system, NAS Patuxent River, 17 April 2007, 21:45 EDT. North is up; radar range setting is 3 nmi (5.5 km), range rings are 0.3 nmi (556 m) apart. Red trails are target tracks; white label at the head of a track is the target's speed, in knots.

The communication of track reports to remote sites uses low bandwidth COTS data channels (wired or wireless). Remote situational awareness for BASH and NRM applications is easily realized because the track reports contain all of the important target information (date, time, position, dynamics, and intensity) as a function of time. Multiple users can operate remote TVWs in different locations simultaneously, with each viewer connected to the same RDS and tailored to process and display the data to each user's mission. For example, personnel in an air traffic control tower could configure a TVW to simply provide an automated alert if a flock of birds moved into any predefined exclusion zones. A wildlife biologist could configure a TVW in a vehicle to provide a real-time display of the same target tracks, directing his/her attention to areas of bird activity. An NRM office or a duty officer could configure a TVW to automatically generate historical avian traffic patterns accumulated over the last several hours, or overnight, to determine whether bird activity was light, normal, or heavy.

In a paper on affordable high-performance radar networks for homeland security applications, Nohara et al. (2008) outlined the procedures for fusing tracks from multiple radars to improve

accuracy and target continuity over single-radar systems.⁵ These authors discuss how their design addressed the two major technical challenges to fusing track data from low-cost radar networks; namely, registration (they used on-line calibration to a known target position or a strong moving target), and the slow scan rate of marine radars with asynchronous scanning. The authors conclude “Fusion can be successfully applied to these low-cost radar networks because of the advanced tracking algorithms used to produce the tracks themselves. With rich and accurate dynamical information, the association problem is less prone to bad assignments, as full use is made of the velocity and turn-rate state values.”

The Accipiter® Radar Fusion Engine (RFE), as illustrated in **Figure 2-7**, is designed to combine track information recorded in the RDS from multiple radars so that remote applications have access to all track data. Remote TVWs or third party software connected to the RDS can display track information from individual radars, or information combined from multiple radars. This capability improves situational awareness in several ways, depending on whether the radars overlap in coverage or not. If radars do not overlap, a single, wide-area display can be generated with tracks originating from radars distant from one another. On the other hand, if radars overlap, the system can track bird movements across larger areas, with track hand-off occurring as the birds move from one radar coverage zone to the next.

An Accipiter® Radar Remote Controller (RRC) is also illustrated in Figure 2-7. This device, combined with network interfaces to the DRP, supports complete remote control of the radars (including powering the radar on/off, switching from transmit to standby, and changing the transmitted waveform). The Automated Radar Scheduler (ARS) can automatically schedule the operation of the radar and the DRP via the RRC.

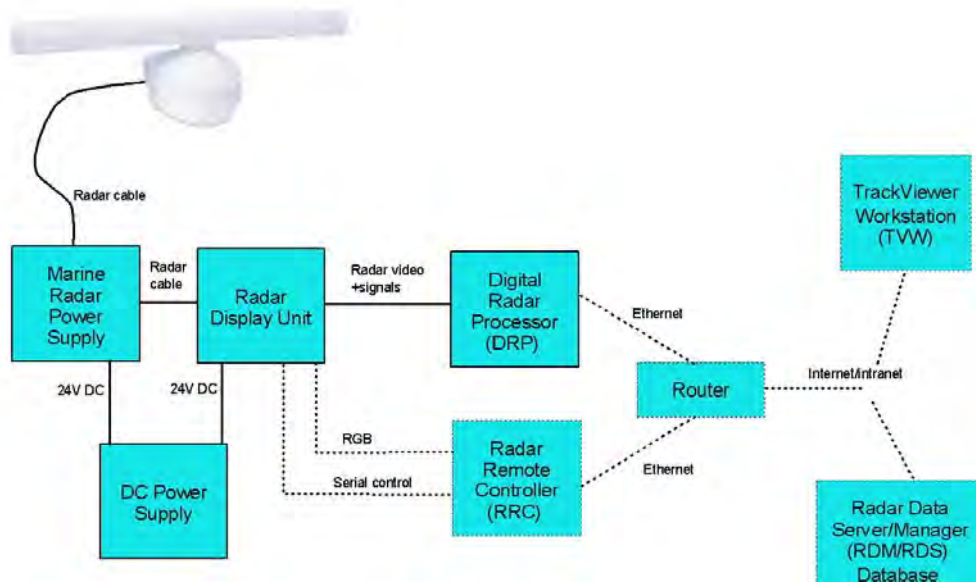

Figure 2-7. Components of a digital avian radar system.

⁵ The network and components employed in the Nohara, et al. (2008) study are identical to those employed at some IVAR study locations.

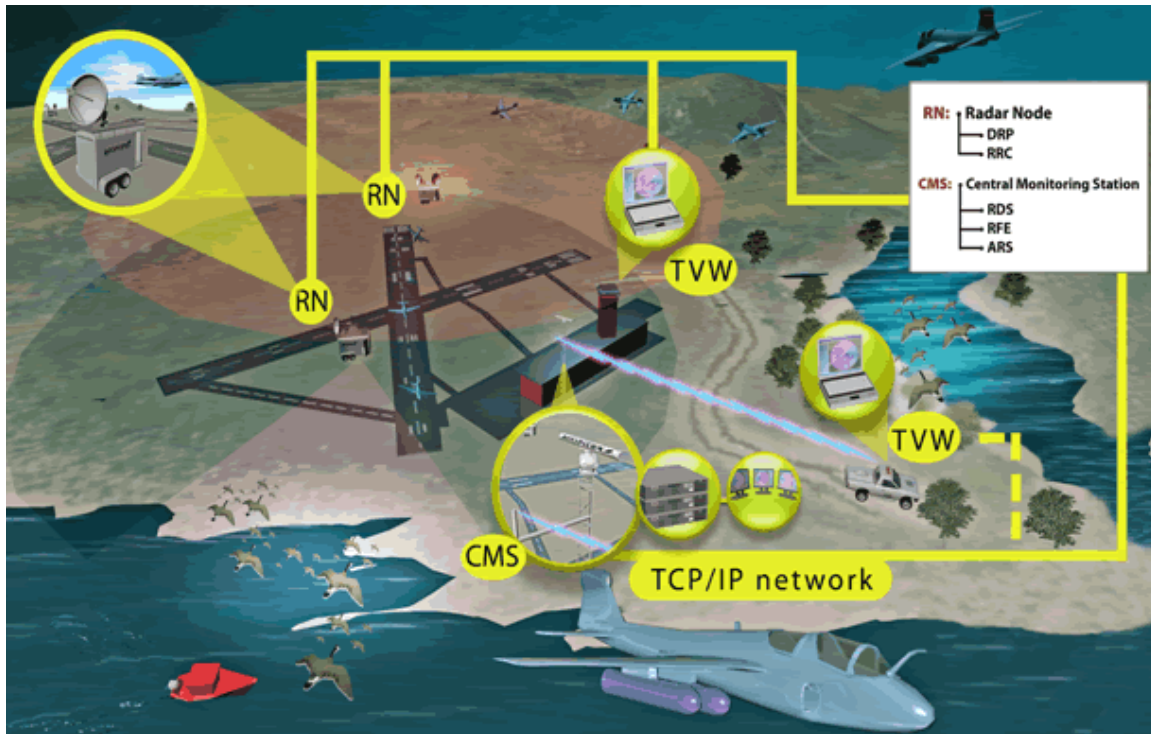

Figure 2-8. Conceptual diagram of an avian radar network.

2.4.4 FAA/CEAT Accipiter® AR-1 and AR-2 radars

The avian radar systems contributed to the IVAR project by the FAA/CEAT have the same processing architecture shown in **Figure 2-7**. Seattle Tacoma International Airport (SEA) has both a stationary, dual-antenna AR-2 (see **Figure 2-9**) and a mobile AR-1 similar to the one shown in **Figure 2-11**. The FAA Research and Development Program (AJP-63) has conducted avian radar assessments since 1999. In 2006 the FAA/CEAT initiated a performance assessment program for commercially available avian radars at civil airports. This assessment program was led by CEAT and included an initial information solicitation from commercial radar vendors. Based on information provided by vendors, Accipiter® Avian Radar Technologies (ARTI: www.accipiterradar.com) was selected for initial radar deployments. ARTI provided an X-band Furuno 8252 marine radar with ARTI digital processing and connectivity hardware and software. The Accipiter Radar avian radar (AR) systems are configured to meet specific civil airport sensing and surveillance needs. For general approach and departure surveillance, the AR radars are equipped with 4° parabolic dish antennas. To provide altitude discrimination two radar sensors (AR-2; specifically SEAAR2l and SEAAR2u) are co-located with parabolic dishes tilted at different angles. To provide general airport coverage a single radar sensor (AR-1; specifically SEAAR1m) is equipped with a 6 ft slotted array antenna.

The initial deployment of avian radar systems at a civil airport was completed at Seattle Tacoma International Airport (SEA). In July 2007 an Accipiter® AR-2 was installed on the Port of Seattle Administration Building at SEA. This AR-2 radar was connected through the Port of Seattle network and was operated remotely from the initial installation. The AR-2 scanners with parabolic dish antennas are shown in Figure 2-9. In September 2008 an AR-1 radar was

permanently installed at SEA. Prior to September 2008 trials with a mobile, trailer mounted AR-1 were conducted and a mid-field location was selected to provide a second radar system at SEA. This second radar systems (SEAAR1m) is located in a shallow valley between Runway 2 and the new Runway 3, Figure 2-10. The SEAAR1m is connected to the Port of Seattle network through a wireless link form the midfield trailer location to the Administration Building.

An AR-1 radar was also deployed to NAS Whidbey Island (NASWI) in March of 2007 as a trailer mounted unit. This radar also incorporated ARTI technology that supported remote operation. Figure 2-11 shows the AR-1 radar (WIAR1m) at NASWI, with the Straits of Juan De Fuca and the San Juan Islands in the distance. Note the roof-mounted Furuno 8252 radar with 1.8 m (6-foot) array antenna. The position of the WIAR1m radar (“RT-1”) at the NASWI facility is shown in **Figure 4-5**. Connectivity for the WIAR1m radar was achieved using a wireless link to an off-base internet service provided.

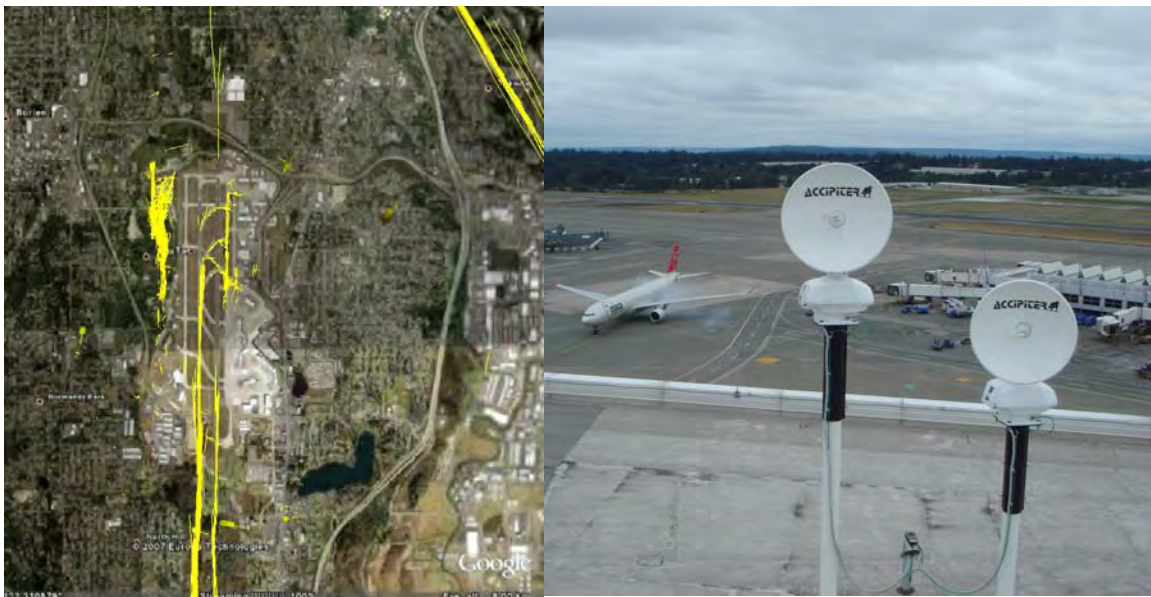

Figure 2-9. AR-2 dual-dish system located at SEA (TVW display on left, AR2 dish antennas on right).



Figure 2-10. AR-1 (SEAAR1m) array antenna system located at SEA. The Port of Seattle station that provides power and the ASR radar for SEA is in the background.



Figure 2-11. Side view of AR-1 (WIAR1m) avian radar unit at NAS Whidbey Island.

2.5 ADVANTAGES AND LIMITATIONS OF THE TECHNOLOGY/METHODOLOGY

The technologies other than radar that researchers have used to detect birds include a wide range of human observations supplemented with optical enhancements (e.g., spotting scopes, binoculars), sensors that record images (cameras and video recording), infrared sensors for tracking and counting birds, and acoustic sensors for bird vocalizations. Each of these technologies has advantages and limitations, and none is superior in all sampling situations. Radar's overall advantage is an aggregate of capabilities that derive from the sensor itself, the processor used to extract information from the sensor, and the operational capabilities of the system. We have listed these advantages and limitations below and compared them to other technologies in Table 2-1.

Advantages:

- Sample day or night;
- Automatic and remote 24/7 operation;
- Sample through 360° of azimuth;
- Detection at ranges ≥ 6 nmi;
- Automated real-time tracking;
- Display tracks over facility maps, aerial photos, etc.;
- Fuse target data for increased situational awareness ;
- Operates in a wide range of environmental conditions;
- Reduced labor costs through unattended operations;
- Immediate production of digital data;
- System data management capabilities to provide opportunities for comparative and historical analysis;
- Network- and Web Services-compliant; and
- Joint use with existing data streams (ASR and NEXRAD)

Limitations:

- Radar physics may limit applications due to target and environmental characteristics;
- Radar beam samples a limited volume (determined by antenna type);
- Resolution based on target reflectivity, thus accurate prediction of species details (e.g., size, shape, density, gender) is problematic;
- Not suited to high-clutter environments (e.g., in forests, near buildings);
- Health & safety issues dependent on unit power and distance to human targets; and
- Variable deployment costs

Table 2-1. Capabilities of Technologies for Sampling Bird Populations.

Capability	Technology				
	Radar (Digital)	Radar (Analog)	Thermal	Auditory	Visual
Automated Real-Time Tracking	√				
Range of Detection	≥11km (6 nmi)	≥11km (6 nmi)	~2.8 km (1.8 nmi)	<0.9 km (0.5 nmi)	~3.7 km (2nmi)
Covers 360° of Azimuth	√	√		√	√
24/7 Operations	√	√	√	√	
Automatic/Remote Control	√			√	
Detects Targets Day or Night	√	√	√	√	
Real-Time Fusion of Target Tracks	√				
Real-Time Geospatial Display	√				
Can Detect All Species	√	√	√		√
Network-Compatible	√			√	
Service-Oriented Architecture	√				
Automated Data Capture	√			√	
Can Detect in All Environments				√	√
Can Identify Species				√	√
Horizon-to-Horizon Coverage					√
Passive Detection			√	√	√

3 PERFORMANCE OBJECTIVES

Table 3-1 lists the six project performance objectives, in the form of 24 quantitative plus 14 qualitative performance metrics with related criteria, for the IVAR Project. We have grouped together the metrics relating to each of the project tasks (see Section 2.4.3) to assist the reader. The numbering conventions used in Table 3-1 are retained throughout this report to facilitate cross-referencing and traceability.

As noted in **Table 3-1**, for all 24 quantitative performance metrics, the related specified success criteria were met or exceeded (“Demonstrated :”), as were all 14 qualitative performance criteria (“Achieved :”).

Table 3-1. Performance Objectives.

Performance Objective	Metrics ^(a)	Description	Data Requirements	Success Criteria	Results ^(b)
Quantitative Performance Objectives					
Automatic Tracking	PA1.1 - Tracks single birds and flocks	Use visual and thermal confirmations to validate targets auto-tracked by radar are birds. Use UAV to independently confirm target’s spatial coordinates.	Using Method #3 [Appendix B], visual observers at different ranges and bearings will confirm as birds targets tracked by radar. Using Method #4, a thermal imager will be used to identify biological targets passing through radar beam. Following Method #5, data from recording GPS in a remotely-controlled helicopter (RCH) will be compared with coordinate data from radar tracks of that target.	Evidence of 100+ ground-truthed tracks at each of 3 geographic locations	Demonstrated: 100+ targets visually confirmed as birds at 3 locations [6.1.1.1.1]; high correlation of radar & thermal tracks for 900+ targets [6.1.1.1.2]; 60% of radar coordinates were within ±10 m of GPS-recorded coordinates from RCH [6.1.1.1.3].

Table 3-1 (cont.).

Performance Objective	Metrics ^(a)	Description	Data Requirements	Success Criteria	Results ^(b)
	PA2.1 - Provides location information versus time for each track	The track data recorded by the radar includes 3D spatial coordinates of the targets.	Representative sample of track data from validation or other studies.	Latitude, longitude, height (and other parameters) recorded every ~2.5 seconds	Demonstrated: 4D coordinates + other parameters recorded for a target during each update – scan – of the radar [6.1.1.2].
	PA3.1 - Track capacity	Radar capable of simultaneously tracking at least 100 targets.	Image of radar display and track records during a period of intense bird activity.	100+ targets tracked simultaneously	Demonstrated: Radar tracked 234 targets simultaneously [6.1.1.3].
	PA4.1 - Tracks single large birds on airfield	Radar capable of tracking large birds within the perimeter of most airfields.	Using data collected following Method #3 [Appendix B], identify visual confirmation(s) of a large bird tracked within the perimeter of the largest study location.	Can track raptor-sized birds out to 2 km range with acceptable uncluttered display.	Demonstrated: Tracked 10 large birds ≥ 2.2 km from the radar [6.1.1.4].
	PA5.1 - Tracks birds beyond airfield	Radar capable of tracking birds beyond the perimeter of most airfields.	Using data collected following Method #3 [Appendix B] for analysis of target flight patterns, identify a large bird tracked outside the perimeter of the largest study location.	Can track birds out to 5 km range.	Demonstrated: Detected and tracked birds out to 5 km range, and up to 3 km beyond the airfield perimeter [6.1.1.5].
Sampling Protocols	PB1.1 - Monitors and records bird tracks 24/7	Radar capable of continuously monitoring bird activity for extended periods of time.	Evidence of continuous track records from a radar at a study location.	One week+ continuous data collection	Demonstrated: 1-hour track histories demonstrate one week of 24/7 operation for two radars [6.2.1.1].
	PB2.1 - Samples birds 360° in field of view	Radar capable of monitoring bird activity from any direction at a facility.	Plots and track data from a study location at which bird activity was widespread	Evidence of bird tracks acquired over 360°	Demonstrated: Track histories from 4 times in one year show tracks in all quadrants [6.2.1.2].
	SB3.1 - Samples out to 11 km (6 nmi)	The instrumented range of the radar exceeds 6 nmi (11 km)	Plots & track data from study location with range set to include 11 km (6 nmi).	Evidence of one or more targets tracked at a range of ≥11 km (6 nmi).	Demonstrated: Multiple birds were tracked ≥11 km (6 nmi) from the EAFB radar [6.2.1.3].

Table 3-1 (cont.).

Performance Objective	Metrics ^(a)	Description	Data Requirements	Success Criteria	Results ^(b)
	PB4.1 - Efficiently stores bird track information	Plots & tracks data storage requirements are low enough to permit accumulating enough data for multi-year comparisons	Determine the mass storage requirements for one year's worth of plots & tracks data files and for the equivalent database storage.	Local storage of one or more years' worth of data is technically feasible and affordable enough to support year-to-year comparison	Demonstrated: The plots & track data files from five radars ranged from 27-190 GB, and would fit on an inexpensive COTS mass storage device [6.2.1.4].
	PB5.1 - Increase in number of birds sampled	Radar detects and tracks more birds than conventional visual sampling methods.	Routine visual census data from an area for which radar track data are available for the same times.	Evidence of 100%+ improvement over baseline visual sampling	Demonstrated: Radar detects 4X birds as a visual observer for 5 min periods; 50X birds for 1-hour periods. [6.2.1.5].
	SB6.1 Samples up to 914 m (3000 ft)	Radar capable of detecting and tracking targets at higher elevations, as might be the case with migrating birds.	Plots & track data collected with a dish antenna angle set high enough so that targets 914 m (3000 ft) AGL or higher are within range.	Evidence of target being tracked at an altitude of at least 914 m (3000 ft) AGL.	Demonstrated: 17 birds were tracked above 914 m (3000 ft) in a selected scan of the radar [6.2.1.6].
Data Streaming	PC1.1 Target data streaming integrity assured	Target data sent over TCP/IP networks arrives at RDS intact.	Using a wired connection to the DRP, select 1-hour period and compare tracks recorded by DRP with those streamed to RDS to identify corrupted values and compute integrity.	Data errors < 5% at a single site, SEA. The RDS will be at ARTI.	Demonstrated: 100% integrity maintained streaming data for 1-hour from SEA to ARTI. [6.3.1.1].
	PC3.1 Wired LAN availability.	Wired network uptime is very high ensuring target data is available to remote users who need it.	Using wired LAN, identify 24 hours of continuous operation and compare scan times of records stored locally by DRP with those streamed to RDS to identify any missing updates and compute availability.	Network availability > 90% at a single site, ARTI (DRP & RDS).	Demonstrated: 100% wired LAN availability maintained for 24 hours at ARTI. [6.3.1.2].

Table 3-1 (cont.).

Performance Objective	Metrics ^(a)	Description	Data Requirements	Success Criteria	Results ^(b)
	PC4.1 Target data organized into database in near real-time while relaying to user.	The avian radar can continuously organize its target data into a SQL database while relaying to user.	Using same setup at ARTI as for PC3.1, demonstrate the RDS can, except for a small latency, keep up with the DRP while relaying tracks to RDS & TVW in real time for a period of one hour.	Time difference between TVW and DRP displays ≤ 5 seconds at a single site, ARTI.	Demonstrated: Latencies were ≤ 4 s when relaying tracks to RDS & TVW at ARTI for a period of 1-hour [6.3.1.3].
	PC5.1 Near real-time bird awareness to air ops personnel	Remote track displays can keep air ops personnel informed of what the radar is seeing and tracking improving avian situational awareness.	Place remote displays such as the TVW, Web-browser-based or Google Earth displays into hands of operations personnel to confirm improved avian situational awareness by soliciting their feedback and rating of the technology.	Overall technology rating 3 or more out of a possible 5, at a single site – either NASWI or SEA.	Demonstrated: Overall technology rating was 3.4 at SEA; [6.3.1.4].
	PC6.1 Automatic early warning of developing bird hazards	The avian radar can issue automatic alerts (e.g. text messages, emails, audible alert) in response to bird tracks moving into operator-specified exclusion zones.	Either Identify recorded dataset(s) of bird movements that presented a hazard that justified an early warning. At ARTI, reprocess the plot data through DRP, stream tracks to an RDS, relay to a TVW with alarm tool programmed to issue a alert to demonstrate early warning capability.	Alarm issued at least 60 seconds before specified event, using data recorded from a single site: NASWI the primary site, MCASCP and SEA are backups.	Demonstrated: Email alert transmitted > 82 seconds before a bird hazard condition reached its climax [6.3.1.5].
	SC2.1 Wired WAN (Internet) availability.	Internet uptime is sufficiently high ensuring target data is inexpensively available to remote users who need it. Designated site: SEA	Same procedure as PC3.1, except use a DRP at the designated site streaming target data over the Internet to RDS.	Network availability > 50% for a single site, SEA. The RDS will be at ARTI.	Demonstrated: 100% network availability maintained for a wired WAN (the Internet) over a 24-hour period [6.3.1.6].
	SC4.1 Wireless LAN availability	Wireless network uptime is reasonably high ensuring target data is available to those who need it.	Same as PC3.1, except the network between the DRP and the RDS is a wireless LAN.	Network availability > 50% at each of three sites: NASWI, SEA, & Edisto.	Demonstrated: Wireless LAN uptimes at SEA and NASWI were 98.7% and 99.2%, respectively [6.3.1.7].

Table 3-1 (cont.).

Performance Objective	Metrics ^(a)	Description	Data Requirements	Success Criteria	Results ^(b)
Data Integration	SD1.1 Near real-time integration for expanded local coverage	The radar tracks from widely separated radars can be brought together in separate displays to a remote user in near-real time.	Run widely separated (>9.3 km [5 nmi] apart) radars, simultaneously streaming tracks to RDS and from there to two side-by-side TVWs to display radar tracks from two separate radars in near-real time.	Time difference between two TVW displays ≤ 10 seconds for data from two sites: SEA, NASWI, or Edisto. ARTI will be a backup site.	Demonstrated: Maximum latencies for the SEA & NASWI radars were 6 seconds; averages were 3 & 4 seconds, respectively. [6.4.1.1].
	SD2.1 Near real-time integration of radar tracks for common operating picture	Tracks from two or more radars can be integrated into a single operator display	Use AR2 and AR1 radars to simultaneously stream tracks to RDS and to Google Earth to display tracks integrated from radars in near-real time; compare time stamps on integrated display with those on separate displays from each radar.	Time difference between two radars in COP ≤ 10 seconds; times displayed in COP are the same as in TVWs. Data from two radars at one site, SEA.	Demonstrated: The maximum (and average) latencies for TVW and Google Earth displays from SEA were 2 & 7 seconds, respectively [6.4.1.2].
Data Fusion	SD3.1 Spatial alignment for fusion of tracks from two radars with overlapping coverage.	Two independent, overlapping radars can be sufficiently spatially aligned to allow a target seen by both to be associated as the same target.	Using Method 6 [Appendix B], for two radars with overlapping coverage identify: Timeframes where both radars simultaneously track a target; compute spatial misalignment error of tracks; compare against the a priori spatial uncertainty.	[Spatial misalignment error] < [3 times the a priori spatial uncertainty] using data collected from two radars at each of three sites: SEA, NASWI, and MCASCP. ARTI will be backup site.	Demonstrated: Spatial misalignment errors (Distance) compared to Uncertainty were 70 m vs. 907 m (SEA); 79 m vs. 1801 m (NASWI); and 63 m vs. 772 m (MCASCP) [6.5.1.1].
	SD4.1 Temporal alignment for fusion of tracks from two radars with overlapping coverage	The time references for two independent radars can be kept sufficiently in sync to support fusion.	Using Method 6 [Appendix B], for two radars with overlapping coverage, observe time stamp (scan times) for two radars at the RDS over one week period and compute temporal misalignment.	[Temporal misalignment] < 5 seconds for data collected from a single site, SEA.	Demonstrated: The maximum temporal misalignment was 0.021313 seconds [6.5.1.2].

Table 3-1 (cont.).

Performance Objective	Metrics ^(a)	Description	Data Requirements	Success Criteria	Results ^(b)
	SD5.1 Near real-time fusion of tracks from two radars with overlapping coverage	Tracks from two radars can be fused into a single operator display, with duplicate tracks in overlapped regions removed and track continuity demonstrated from one radar to the other.	Using five examples from a pair of radars with overlapping coverage at the designated site, identify times when target(s) were present in the overlapped region and follow fusion processing in Method 6 in [Appendix B] to show duplicate tracks consolidated and track continuity, with resulting fused tracks computed and displayed in near-real-time.	Fusion processing time \leq real-time duration for each of five 5-minute paired track data samples. Five samples drawn from three sites, with at least one example from each from NASWI, MCASCP, and SEA. ARTI will be a backup site.	Demonstrated: Computation rate of the Radar Fusion Engine (RFE) was ~30-times faster than real time for datasets with 30 or more targets from NASWI, MCASCP, and SEA [6.5.1.3].
Additional	PE1.1 Reduce compliance cost	Avian radars will show a positive net cost-benefit	Data from cost and operation of radars as part of the IVAR and CEAT projects.	50% reduction compared to previous ROI	Demonstrated: The hourly rate for the radar was estimated to be 98% lower than that of a senior wildlife biologist [6.6.1.1]
Qualitative Performance Objectives					
Automatic Tracking	PA1.2 - Automates real-time tracking of radar echoes	Automated tracking algorithms can detect and track targets in real time at least as well as a human operator.	Digital image that faithfully emulates analog radar display, including “true trails” mode. Digital image demonstrating automatic tracking of the same targets as in the analog scene.	Achievable	Achieved: Both simulations and image comparisons demonstrated eBirdRad can automatically track targets in real time [6.1.2.1].
	PA2.2 - Provides reduced clutter compared to analog radar	Remove “ground clutter” (returns from stationary objects) to reveal moving targets that were masked by the clutter.	Digital images of the same scene with and without clutter removal.	Achievable	Achieved: Image comparisons demonstrated eBirdRad can reduce clutter & reveal additional targets [6.1.2.2].

Table 3-1 (cont.).

Performance Objective	Metrics ^(a)	Description	Data Requirements	Success Criteria	Results ^(b)
Sampling Protocols	PB1.2 - Sampling of diurnal and seasonal bird activity patterns	Capable of sampling bird activity night and day and at different times of the year.	Log of plots & track files generated during a 24-hour period every three months at the same location.	Achievable	Achieved: Diurnal sampling demonstrated in 6 Performance Criteria, seasonal sampling in 4 Criteria[6.2.2.1].
	PB2.2 - Scheduled, unattended sampling events	Systems capable of being programmed in advance to power-on the radar, collect and record plots & track data, and power-down the radar at specified times, without human intervention.	Screen image from the radar scheduler for a specific event; log of the plots and tracks files generated during that event; Master and Detail records for selected tracks from that event.	Achievable	Achieved: Successfully powered-on radar, captured plots & tracks data, and powered off radar according to pre-programmed schedule, with no human intervention [6.2.2.2].
	PB3.2 Sampling controllable by remote operator	The ability to control the configuration and operation of the radar from a remote location.	Image of the remote operator's console; log of the plots and tracks files generated during that event; Master and Detail records for selected tracks from that event.	Achievable	Achieved: Commands were issued from ARTI to a radar at SEA and visually confirmation to have been executed [6.2.2.3].
	PB4.2 - Provides spatial distributions of birds over periods of time	Capable of tracking targets over periods of time sufficient to compare their diurnal (daily) and seasonal activity patterns.	Plots of bird activity at the same location over a 24-hour period and during different seasons of the same year.	Achievable	Achieved: Generated a 24-hour track history for three dates and 12 2-hour track histories for one date at SEA [6.2.2.4].
	PB5.2 - Provides spatial distributions of birds overlaid on maps	Display bird tracks overlain on geo-referenced aerial photograph or map for a specified period of time.	Image of track history display from the Track Viewer Workstation; image of Google Earth display generated by Track Data Viewer.	Achievable	Achieved: Overlaid 24-hour track history on a map of SEA in TVW; exported and viewed same track histories in Google Earth [6.2.2.5].

Table 3-1 (cont.).

Performance Objective	Metrics ^(a)	Description	Data Requirements	Success Criteria	Results ^(b)
	PB6.2 - Provides bird tracks in format suitable for GIS	Capable of outputting track data in KMZ or SHP file formats.	Image of Google Earth display generated by Track Data Viewer; image of Google Earth real-time display of data streaming from DRP.	Achievable	Achieved: Displayed both real time and archived track data from RDS in Google Earth [6.2.2.6].
	PB7.2 - Provides bird abundance over periods of time	Capable of accumulating number-of-targets (abundance) data over a specified period of time.	Display of track histogram plots generated by TVW.	Achievable over hourly, daily or seasonal time periods	Achieved: Plotted daily abundance data for 1 year from SEA, and detailed 5-day plots of the same data [6.2.2.7].
	PB9.2 - Samples birds at night	Capable of detecting and tracking birds at night, when other sampling methods are ineffective.	Display of track history plots during nighttime periods from different times of the year.	Achievable	Achieved: Plotted bird abundance from SEA at hourly intervals, day and night, for five consecutive days [6.2.2.9].
Additional	PE1.2 Ease of use.	The system can be operated by a person who has little to no radar background with a small amount of training.	Documentation of project members who had no prior radar background or training who learned to operate the eBirdRad or AR radars.	Achievable	Achieved: A total of 28 individuals received training, and 11 are active users [6.6.2.1].
	SE2.2 System reliability	System components run robustly under normal operating conditions.	Records of operational performance of one of the radars at NASWI or SEA.	Achievable	Achieved: Systems operated for >1 year with minor maintenance [6.6.2.2].
	SE3.2 Safety radiation hazard.	Radiation hazard to humans, fuels, and ordnance can be easily managed.	Demonstration how operation of radars can meet HERP, HERF, and HERO conditions.	Achievable	Achieved: Described process at NASPR for obtaining fuels, ordnance, and personnel safety hazard approvals [6.6.2.3].

Table 3-1 (cont.).

Performance Objective	Metrics ^(a)	Description	Data Requirements	Success Criteria	Results ^(b)
	SE4.2 Maintenance	Life cycle support is available – maintenance can be managed by military maintenance personnel.	Maintenance information from IVAR and CEAT projects.	Achievable	Achieved: Routine maintenance can be handled by local personnel [6.6.2.4].

NOTES:

(a) Performance Objective/Metrics/Criteria Numbering Convention: First character indicates P=Primary or S=Secondary criterion; Second character indicates – A=Automatic Tracking, B=Sampling Protocol, C=Data Streaming, D=Integration and Fusion, or E=Additional the performance objective; Third through fifth characters are the sequential numbers of the criterion, with n.1=Quantitative and n.2 = Qualitative criteria.

(b) Section numbers included in square brackets “[]” provide a reference and link to the section of the report that provides the results for each performance criterion.

3.1 SUMMARY DESCRIPTION OF PERFORMANCE OBJECTIVES

As discussed in Section 1.2, we established six project objectives to demonstrate different aspects of the maturity and operational capabilities of digital avian radar systems based on user requirements we developed during prior studies. Within these groupings, we created 38 metrics and criteria to evaluate the systems’ performance relative to the six objectives: Twenty-four of these were quantitative metrics/criteria and 14 were qualitative metrics/criteria. Table 3-1 provides an overview of the 38 performance criteria, the sections below expand upon those criteria in terms of the objectives and metrics they were designed to test, and Section 5.6 presents the results of the evaluation of those criteria.

3.1.1 Automatic Tracking

Automatic tracking of targets is a core requirement of digital avian radar systems. Nearly all other features and capabilities of these systems derive from the ability to automatically track birds in real time. Consequently, we devoted much of the effort and many of the resources of the IVAR project to the demonstration and validation of this capability of the systems being evaluated.

3.1.1.1 Quantitative Performance Criteria

The performance objectives discussed in the following subsections were designed to evaluate automatic tracking quantitatively; that is, the Success Criteria were defined as a numeric quantity against which the results of testing the radar system could be evaluated.

3.1.1.1.1 Tracks Single Birds and Flocks [PA1.1]

We established Performance Criteria PA1.2 (Automates Real-Time Tracking of Radar Echoes) and PA2.2 (Provides Reduced Clutter Compared to Analog Radar) to demonstrate that the Accipiter® digital radar processor used in the eBirdRad avian radar systems can:

- Faithfully reproduce digitally the same images, including the echoes from moving targets that an observer would see on the analog radar display.
- Through the suppression of ground clutter, expose echoes from moving targets that were not visible on the analog display.
- Automatically detect the echoes of moving targets and identify from scan-to-scan those echoes belonging to particular targets and combined the appropriate echoes into target tracks, all in step with the radar's scan rate of 2.5 seconds/scan (here nominally referred to as "real time"; Section 2.4.1).
- Record detailed data about the position and behavior of the targets being tracked.

The three sets of tests conducted as part of Performance Criterion PA1.1 were designed to: 1) Visually confirm that targets being automatically tracked by the radar were birds, either individuals or flocks of birds; 2) Use thermal imaging as a second method of confirming that targets being automatically tracked by the radar were birds; and 3) Track a remotely controlled aerial vehicle for independent verification the accuracy of the spatial and temporal coordinates being generated by the radar. We set as our success criterion for this objective that we would be able to confirm 100 or more targets tracked by the radar at three different geographic locations.

The first of these tests, Validation by Visual Confirmation, involved deploying teams of trained birders at various distances and bearings from the radar, at different geographic locations, and during different seasons and times of the day, and asking these teams to “ground-truth” the targets that were being tracked by the radar. Using two-way radios for communications, either the radar operator asked the visual teams to confirm a target the radar was tracking was a bird or the visual teams first saw a bird they thought was in the radar beam and asked the radar operator for confirmation.

The visual confirmation studies, while very labor-intensive and time-consuming, were undertaken because no published studies were available that had used quantitative and objective methods to confirm the targets digital avian radars were tracking were in fact birds – a most basic assumption underlying the use of this technology.

The second set of tests, Validation by Thermal Confirmation, addressed the same objective – confirming the tracked targets are birds – by using the infrared (thermal) portion of the electromagnetic spectrum to observe birds being tracked by the digital avian radar system. Thermal imaging has the additional benefit that it works at night, while visual observations can only be made during daylight.

The device used to make these observations employs a thermal imaging video camera pointed vertically to detect the heat signatures of the birds (and bats and insects) as they pass overhead, together with a vertically-pointed radar that recorded the height of these targets. The IVAR team positioned this system at different distances from the avian radar and correlated the tracks of the targets observed by both systems.

For the third test, Validation Using A Remotely Controlled Vehicle, we used a recording GPS onboard a remotely controlled helicopter to record the coordinates of the helicopter as it was flown through a series of maneuvers, while an avian radar system was automatically tracking the same target. We then plotted and compared the tracks from the GPS and the avian radar to determine how closely they were matched in time and space.

Two other sets of tests related to the question of how well the digital avian radar systems we test can automatically track targets are discussed in Sections 3.1.1.2.1 and 3.1.1.2.2.

3.1.1.1.2 Location Information versus Time for Each Track [PA2.1]

Once automatic detection and tracking of birds in real time was demonstrated, the next capability we addressed was whether the data captured for each tracked target would be useful to the end-users of these systems. Of particular importance in this regard is the ability to record the three spatial and the temporal of each tracked target. We chose to demonstrate this capability by examining the fields display in the TrackDataViewer® software supplied with the Accipiter® avian radar systems. We set as our success criterion that the spatial and temporal coordinates of each tracked target should be available from each scan of the radar (every ~2.5 seconds)

3.1.1.1.3 Track Capacity [PA3.1]

Given that the detailed data gathered for each tracked target provided useful information to the end-users, can the radar track and gather these types of data for a reasonable number of targets tracked simultaneously in real time? We chose to demonstrate this capability by examining the plots and tracks data from one of our validation studies that was conducted during a period of migration when lots of birds were likely to be in flight at the same time. We set as our success criterion for track capacity that the system should be capable of tracking and recording the data from 100 or more targets simultaneously.

3.1.1.1.4 Tracks Single Large Birds on Airfield [PA4.1]

The previous objective examined the question of whether the avian radar system could automatically track a reasonable number of targets simultaneously. If it can, then can it also track targets out to a range that includes the perimeter of most military airfields? To demonstrate this capability, we chose 2 km as a range from the radar that would encompass the perimeter of most military airfields. We then set as our success criterion that we would be able to automatically detect and track a large, raptor-sized bird at that distance or farther.

3.1.1.1.5 Tracks Birds Beyond Airfield [PA5.1]

Because birds move freely across the boundaries of military facilities, wildlife incidents on the base are often related to activities outside the fence line. Therefore, tracking birds beyond the perimeter of an airfield can be as important as tracking them inside the perimeter. Criterion PA5.1 was designed to demonstrate that avian radar systems are capable of tracking birds up to 5 km from the radar; that is, up to 3 km beyond the perimeter of a typical airfield.

3.1.1.2 Qualitative Performance Criteria

The performance objectives discussed in the following subsections were designed to evaluate sampling protocols qualitatively, with success criteria that could be defined in terms of “Achieved” or “Not Achieved”.

3.1.1.2.1 Automates Real-Time Tracking of Radar Echoes [PA1.2]

Digital avian radars are relatively new technology and few of the potential end-users will have had any practical experience with this technology. We designed this qualitative criterion to examine two fundamental questions about the capabilities of the Accipiter® digital radar processor (DRP) use in the IVAR (and CEAT) studies. First, how well can the DRP track targets with well-defined flight dynamics? To evaluate this question, we used software to generate simulated targets with known flight dynamics similar to birds. We set as our success criterion that the demonstration would have achieved its objective if the targets displayed on the screen of the DRP matched the flight dynamics of the synthetic targets in the input data files.

The goal of the second questions was to demonstrate whether the DRP can faithfully reproduce the plan position display of analog radar systems with which radar ornithologists are quite familiar. Here we directed the same raw analog signal from an operating X-band marine radar into the input of both an older analog BirdRad avian radar and a newer digital eBirdRad avian radar. This demonstration would be judged to be successful if the digital display of the scenes closely matched the analog display of the same scenes.

3.1.1.2.2 Provides Reduced Clutter Compared To Analog Radar [PA2.2]

The antennas of avian radars are oriented close to horizontal in order to detect low-flying birds, and consequently, radar echoes from the ground, buildings, and other stationary objects (i.e., “ground clutter”) are a serious problem that can adversely affect the ability of the DRP to detect and track targets. To demonstrate the Accipiter® DRP can remove ground clutter from a scene while still detecting and tracking targets in that scene, we compared the images generated by the DRP when: A) The clutter suppression algorithms were turned off; B) the clutter suppression algorithms were turned on and the targets were “tracked” using the analog “true trails” display; and C) the clutter suppression algorithms were turned on and the targets were tracked digitally by the DRP. The would be judged successful if targets that were visible in the cluttered display were still visible in the uncluttered displays, targets that were not visible in the cluttered display were visible in the uncluttered displays, and all of these targets were tracked in the digital display.

3.1.2 Sampling Protocols

Performance criteria in this category were designed to demonstrate that the digital avian radar systems evaluated by the IVAR project collect the types of data users require and can do so under the operating conditions that can be expected to be encountered at military facilities.

3.1.2.1 Quantitative Performance Criteria

The performance objectives discussed in the following subsections were designed to evaluate sampling protocols quantitatively. That is, the Success Criteria were defined as a numeric quantity against which the results of testing the radar system could be evaluated.

3.1.2.1.1 Monitors and Records Bird Tracks 24/7 [PB1.1]

A principal advantage of radar as a tool for sampling bird populations is its ability to operate continuously, day and night, collecting data under a wide range of environmental conditions. We designed Criterion PB1.1 to demonstrate this capability to sample continuously in the

temporal domain by recording all bird tracks at a given facility for a period of one week or longer.

3.1.2.1.2 Samples Birds 360° in Field Of View [PB2.1]

Another advantage of radar as a sampling tool for birds is its ability to sample throughout a full 360° field of view around the radar. We designed Criterion PB2.1 to demonstrate this capability by showing that the numbers of birds tracked at various bearings from the radar were roughly the same over the course of a year (to allow for differences in diurnal and seasonal distribution of the birds).

3.1.2.1.3 Samples Out To 6 Nautical Miles [SB3.1]

Criteria PA4.1 (Section 3.1.1.1.4) and PA5.1 (Section 3.1.1.1.5) were designed to demonstrate that avian radar systems can track birds within and immediately beyond the perimeter of most military airfields. We designed Criterion SB3.1 to demonstrate they can track birds out to a range of 11 km (6 nmi). This distance was chosen because one of the design specifications for the original BirdRad avian radar system was to sample in the range 0-11 km (0-6 nmi).

3.1.2.1.4 Efficiently Stores Bird Track Information [PB4.1]

Recording a wide range of parameters for hundreds-to-thousands of birds that are being tracked 7/24, with a new track record being generated for each target 24 times a minute, could generate a volume of data that might overwhelm conventional data storage media. Criterion PB4.1 was designed to demonstrate that a year's worth of plots and tracks data from a continuously operating avian radar system could be stored on a conventional data storage device.

3.1.2.1.5 Increase in Number of Birds Sampled [PB5.1]

One would assume that digital avian radar systems, with their ability to sample continuously, day and night, through a 360° field-of-view, over ranges of 0-11 km and up to altitudes of a kilometer would sample more birds than visual observers using conventional sampling methods. We designed Criterion PB5.1 to test that assumption and we set as our success criterion that the radar would detect and track twice as many birds as the human observers.

3.1.2.1.6 Samples Up To 3000 Feet [SB6.1]

Being able to track migrating birds is an important capability for both the natural resources management and the air safety applications for avian radar systems. Because migrating birds often fly at altitudes up to a kilometer (~3000 feet) or more, we designed Criterion SB6.1 to demonstrate that digital avian radar systems can track birds at those altitudes.

3.1.2.2 Qualitative Performance Criteria

The performance objectives discussed in the following subsections were designed to evaluate sampling protocols qualitatively, with success criteria that could be defined in terms of "Achieved" or "Not Achieved".

3.1.2.2.1 Sampling Of Diurnal and Seasonal Bird Activity Patterns [PB1.2]

One advantage of digital avian radar systems is that they sample continuously day and night, and therefore can be used to build up historical records of short-, intermediate-, and long-term temporal bird activity patterns. To demonstrate this capability of the Accipiter® avian radar systems evaluated by the IVAR project, we proposed to use the plots and tracks data for a 24-

hour period from a single location to illustrate the capture of diurnal activity patterns, plus the plots and tracks data for a 3-month period to illustrate the capture of seasonal activity patterns. We proposed to plot the number of birds per unit time (e.g., hour) over these two intervals to illustrate this capability.

3.1.2.2.2 Scheduled, Unattended Sampling Events [PB2.2]

Another advantage of digital avian radar systems is that they provide “unattended” operation. Not only can the processor automatically detect and track targets, but the entire system can operate without human intervention – except for routine maintenance. To illustrate this latter capability, we proposed to demonstrate that not only could the system operate unattended, but that it could be pre-programmed in advance to power-up the radar hardware on a specified date and time, record plots and tracks data for a specified period of time, and then power-down the radar hardware without an operator being present to perform these functions.

3.1.2.2.3 Sampling Controllable By Remote Operator [PB3.2]

Another dimension of unattended operations is the ability to have a human operator control the radar much as we did in Criterion PB2.2, but to do it remotely. We proposed to demonstrate that this capability is “Achievable” by issuing a series of commands to the radar from a remote workstation over a communications network, capturing screen images to show the commands we issued were executed by the radar, and the corresponding effects of these commands had on the radar data processing.

3.1.2.2.4 Provides Spatial Distributions of Birds over Periods Of Time [PB4.2]

As noted in Criterion PB1.2 and elsewhere, the ability to playback archived plots and track data and save spatial representations of target activity over user-definable periods of time (i.e., “track histories”) is a powerful tool for both natural resources management and aircraft safety applications of avian radar systems. We designed Criterion PB4.2 to demonstrate this capability by generating a series of 24-hour track histories from the same radar during different seasons of the year.

3.1.2.2.5 Provides Spatial Distributions of Birds Overlaid on Maps [PB5.2]

Whereas Criterion PB4.2 was designed to demonstrate the ability to generate plots of the temporal distributions of bird activity at a given location, Criterion PB5.2 was designed to demonstrate generating spatial maps of bird activity at a facility over a specified period of time.

3.1.2.2.6 Provides Bird Tracks in Format Suitable for GIS [PB6.2]

While the Accipiter® avian radar systems come with a robust set of data analysis and visualization tools, some users will want to transfer the data from the avian radar into third-party products for further processing and display. For that reason, the avian radar system should provide the option to generate output data formats that are compatible with existing industry standards. We designed Criterion PB6.2 to demonstrate that the Accipiter® systems the IVAR project evaluated can output data in the Keyhole Markup Language (KML) format used by many geographic information systems (GIS), notably Google Earth, for both both real-time and static displays.

3.1.2.2.7 Provides Bird Abundance over Periods of Time [PB7.2]

Criteria PB4.2 and PB5.2 presented the temporal and spatial distribution of bird activity as plan position or georeferenced map displays. We designed Criterion PB7.2 to demonstrate that the distribution of bird abundance data over time can also be displayed as a histogram. For this demonstration we chose to plot the total number of tracks on a daily basis for one year.

3.1.2.2.8 Provides Seasonal Comparison Distributions [SB8.2]

We designed Criterion SB8.2 to be an extension of PB7.2 by selecting from the year's worth of data several 5-day intervals to represent different seasons and displaying the abundance data for these intervals on an hourly basis.

3.1.2.2.9 Samples Birds at Night [PB9.2]

The ability to sample birds at night is one of the primary advantages of avian radar over other methods of sampling birds - especially for locations that must provide around-the-clock situational awareness of bird activity. PB9.2 was designed to demonstrate this capability by presenting hourly trends and track histories to illustrate that nighttime sampling of bird activity is achievable with digital avian radar systems.

3.1.3 Data Streaming

Data streaming is the process of transmitting digital data, typically across a communications network, from where the data were generated (i.e., at the location of the avian radar) to where the data will be used (e.g., the wildlife management office) or stored (e.g., a historical database).

3.1.3.1 Quantitative Performance Criteria

The performance objectives discussed in the following subsections were designed to evaluate data streaming quantitatively; that is, the Success Criteria were defined as a numeric quantity against which the results of testing the radar system could be evaluated.

3.1.3.1.1 Target Data Streaming Integrity Assured [PC1.1]

It is essential to ensure the integrity of the data being transmitting across a communications network. We designed Criterion PC1.1 to demonstrate that data generated at a radar location could be streamed over the Internet to a storage location several thousand kilometers away with an error rate of 5% or less.

3.1.3.1.2 Wired LAN Availability [PC3.1]

The availability (i.e., "up-time") of the network used to transmit the data from the radar system in the field to a remote processing/storage site across a local-area network (i.e., within a facility) must be high. We set as our success criterion to demonstrate this capability a 90% up-time for a wired communications network.

3.1.3.1.3 Database Target Data Organized Into In Near Real Time [PC4.1]

By the same token, it's equally important that the application at the other end of the data stream be able to keep up with the rate at which data are being generated by the avian radar system and streamed across the network. We chose the RDS to demonstrate this capability because the architecture of the Accipiter® avian radar systems uses the RDS both to store plots and tracks data for historical analysis, as well as to redistribute the data for real-time applications. We set

as our success criterion for this demonstration that the RDS would not add more than 5 seconds (~2 scan periods) of latency between the time when the data were generate and when they were available for display or processing.

3.1.3.1.4 Near-Real-Time Bird Awareness to Air Ops Personnel [PC5.1]

While we have proposed a variety of criteria to evaluate the performance of the digital avian radar systems evaluated by the IVAR project, the bottom-line criterion is: how well does it perform in supplying the information end-users need? We framed Criterion PC5.1 to address that question by asking air operations personnel to rate the overall usefulness of this technology for their application, on a scale of 1-5, with a score of 3 (“Good”) being acceptable.

3.1.3.1.5 Automatic Early Warning of Developing Bird Hazards [PC6.1]

One of the important potential applications for digital avian radar systems is to provide early warning to air operations personnel of a developing hazardous condition related to birds. We designed Criterion PC6.1 to demonstrate this capability by testing the ability of the Accipiter® avian radar systems to detect such a condition and to generate a notice that would give the appropriate personnel enough time (<1 minute before the event) to take corrective actions.

3.1.3.1.6 Wired WAN (Internet) Network Availability [SC2.1]

Criterion PC3.1 (Section 3.1.3.1.2) was designed to test the availability of a local-area network. We designed Criterion SC2.1 to test the availability of a wide-area network (WAN), in this case the Internet, for transmitting plots and tracks data over a distance of thousands of kilometers. We set as our success criterion that the WAN would be available at least 50% of the time.

3.1.3.1.7 Wireless LAN Availability [SC4.1]

Criterion PC3.1 (Section 3.1.3.1.2) tested the availability of a wired local-area network. Often, however, a wired connection is either not available or not practical (e.g., providing situational awareness to a wildlife manager is a vehicle). Therefore, we designed Criterion SC4.1 to demonstrate whether the availability of a wireless LAN connection could be maintained at 50% up-time or better.

3.1.4 Data Integration

Data integration involves taking the track data from two or more avian radar systems and combining them into a single display – often referred to as a Common Operational Picture (COP). A basic assumption of integrating tracks into a COP is that the spatial coordinates of the tracks are accurate – an assumption we tested using a UAV in PA1.1 (Section 3.1.1.1.1). In this section we describe two tests designed to demonstrate the temporal alignment of the track data from multiple radars.

3.1.4.1 Quantitative Performance Criteria

The performance objectives discussed in the following subsections were designed to evaluate data integration quantitatively; that is, the Success Criteria were defined as a numeric quantity against which the results of testing the radar system could be evaluated.

3.1.4.1.1 Near Real-Time Integration for Expanded Local Coverage [SD1.1]

A principal objective of data integration is to expand the coverage volume by operating two or more radars and combining their track data in a COP display. In order to do this, however, the

difference in the time (i.e., the latency) of the track data arriving from the two radars must be minimal. We designed Criterion SD1.1 to demonstrate this capability for two widely-separate radars that were ~100 km apart. We set as our success criterion that the latency in the real-time values between these two systems would be <10 seconds (i.e., roughly four scans of the radar).

3.1.4.1.2 Near Real-Time Integration for Common Operating Picture [SD2.1]

For the next demonstration of data integration we chose to stream the track data from two radars approximately a meter apart on the roof at SEA International Airport to an RDS over 3000 km away. This test would be judged a success if the latency of the track data from the two radars displayed separately and the latency of the track data from the two radars integrated into a COP using Google Earth is <10 seconds.

3.1.5 Data Fusion

Whereas data integration simply combines the tracks from independent radars into a common display, data fusion involves combining tracks generated by radars with overlapping coverage into common tracks. Data fusion has the added advantage of providing greater track continuity for targets moving from the coverage volume of one radar to the next. Data fusion also requires a more rigorous demonstration of both the spatial and the temporal alignment of the tracks from the independent radars.

3.1.5.1 Quantitative Performance Criteria

The performance objectives discussed in the following subsections were designed to evaluate data fusion quantitatively; that is, the Success Criteria were defined as a numeric quantity against which the results of testing the radar system could be evaluated.

3.1.5.1.1 Spatial Alignment for Fusion between Two Radars [SD3.1]

We designed Performance Criterion SD3.1 to demonstrate that two asynchronous radars can be spatially aligned within acceptable error to provide meaningful target data for fusion. We chose to use data from three study locations that each had two radars with overlapping coverage: We set as our success criterion that the spatial misalignment error for each pair of radars would be less than three times the *a priori* spatial uncertainty value.

3.1.5.1.2 Temporal Alignment for Fusion between Two Radars [SD4.1]

Criterion SD4.1 was designed to test the other component of the misalignment error, the temporal misalignment. We chose to test this component by demonstrating that the time reference for two independent radars can be kept sufficiently in synchronization to support fusion; namely, that the system clocks of the two radars did not differ by more than 5 seconds over the period of one week.

3.1.5.1.3 Data Fusion [SD5.1]

We designed Criterion SD5.1 to demonstrate that the fusion algorithms used in the avian radars being evaluated by the IVAR project can be applied in near real-time and presented in a COP that shows duplicate tracks consolidated. Again we used three locations that each had two radars with overlapping coverage for our demonstration. We directed the paired track data from these locations into the Accipiter Radar Fusion Engine (RFE) and set as our success criterion that the processing time for each paired dataset must be less than the respective actual time interval associated with that dataset.

3.1.6 Additional Criteria

The criteria assigned to this category are related to the use and utility of avian radar systems rather than to the technical performance of these systems.

3.1.6.1 Quantitative Performance Criteria

The performance objective discussed in the following subsection was designed to evaluate reducing compliance costs quantitatively; that is, the Success Criterion was defined as a numeric quantity against which the results of acquiring and operating the radar system could be evaluated.

3.1.6.1.1 Reduce Compliance Costs [PE1.1]

Our goal for establishing Criterion PE1.1 was to demonstrate that avian radar systems, in addition to collecting more data and more complete data than other methods of sampling bird populations, could also reduce the cost of collecting those data. We chose to evaluate two elements of cost, that of the radar being an improved sampling tool and further that digital avian radar systems provide a better and less labor-intensive method of managing the sampling data for bird populations. We set as our success criterion that avian radar systems could reduced the cost of acquiring data for regulatory compliance by at least 50%.

3.1.6.2 Qualitative Performance Criteria

The performance objectives discussed in the following subsections were designed to evaluate sampling protocols qualitatively, with success criteria that could be defined in terms of “Achieved” or “Not Achieved”.

3.1.6.2.1 Ease of Use [PE1.2]

While technical sophistication is important, the ease with which end-users can operate an avian radar to collect the data they need is equally important if the system is to be used for its intended application. We designed PE1.2 to evaluate how well potential users with no prior radar background or training could learn to use the avian radar systems being evaluated by the IVAR project.

3.1.6.2.2 System Reliability [SE2.2]

While the reliability of a field sampling device is always an important consideration, it is doubly important when the system is designed to operate unattended, automatically collecting the requisite data. Nothing is more frustrating that to leave a sampling device operating on its own only to learn after-the-fact that the system has failed or the data have been corrupted. We designed Criterion SE2.2 to demonstrate that the avian radar systems being evaluated by the IVAR project could be operated reliably for extended periods of time, with little or no operator intervention.

3.1.6.2.3 Safety Radiation Hazard [SE3.2]

The X-band marine radars used by most avian radar systems emit microwaves with a frequency range of 8-12 GHz, corresponding to a wavelength of ~3 cm. Radio frequency (RF) radiation at this wavelength, while nonionizing, can cause health effects in humans and the detonation of both fuels and ordnance. Criterion SE32 was designed to demonstrate that simple procedures can permit avian radar system to be operated safely.

3.1.6.2.4 Maintenance [SE4.2]

We established Criterion SE4.2 to establish whether the personnel at a military facility were able to maintain the components of a digital avian radar system, with minimal support from the vendor.

4 STUDY LOCATIONS

Figure 4-1 displays and **Table 4-1** lists the seven IVAR study locations. Sections 4.1 through 4.7 provide details on each of these locations.

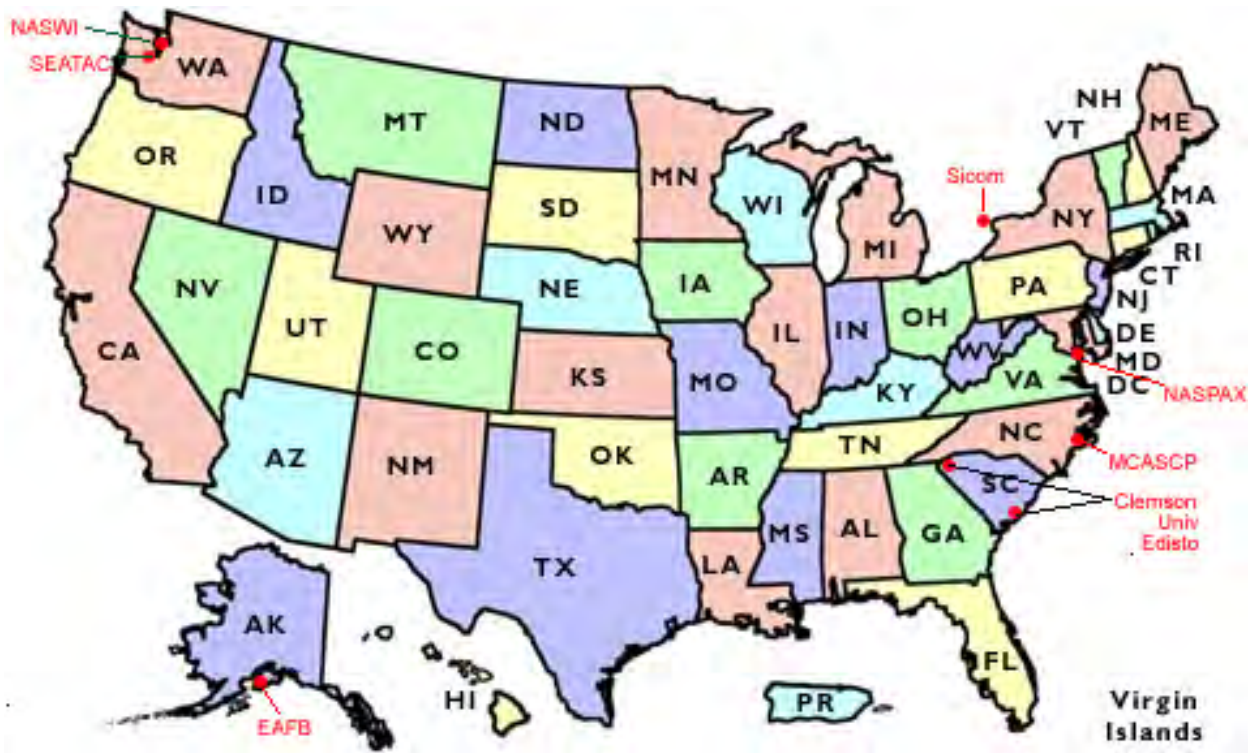

Figure 4-1. Map of IVAR study locations. “Sicom” = ARTI.

Table 4-1. Summary of the IVAR study locations. ‘X’ indicates the specified type of demonstration was conducted at that location; ‘B’ indicates a potential Back-up locations for the specified demonstration.

Location	Demonstrations							Activity
	Visual Confirmation	Thermal Validation	UAV Studies	Sampling Protocols	Data Streaming	Data Integration	Data Fusion	
MCAS Cherry Point, North Carolina	X	B	B	X		B	B	Very large air station; eastern seaboard; high seasonal and daily bird activity; periods of heavy air operations; 1-year visual census; multiple eBirdRad radars; fiber-optic wired LAN (planned)
NAS Patuxent River, Maryland	X	B		X				Medium-sized air station; northeastern seaboard; high seasonal and daily bird activity; eBirdRad acceptance testing site; single eBirdRad radar; no LAN/WAN capability.
NAS Whidbey Island, Washington	X			X	X	X	X	Smaller air station; western seaboard; high seasonal and daily bird activity; periods of heavy air operations; multiple radars (eBirdRad & AR1); wireless (WiFi & EVDO) connectivity.
Elmendorf AFB, Alaska	X			X				Large airbase; arctic seaboard; high seasonal bird activity; periods of heavy air operations; single eBirdRad radar; no LAN/WAN capability.

Table 4-1 (cont.).

Location	Demonstrations							Activity
	Visual Confirmation	Thermal Validation	UAV Studies	Sampling Protocols	Data Streaming	Data Integration	Data Fusion	
SEATAC Int'l Airport, Washington			X	X	X	X	X	Moderate-size airport; bird activity; moderate-to-heavy air operations; Multiple radars; wired & wireless (WiFi) LAN & WAN.
Edisto Island (Clemson), South Carolina		X		X	B	B		High seasonal and daily bird activity; no air operations; single radar (eBirdRad); thermal imager; wired & wireless LAN (WiFi). WAN (DSL).
ARTI Ontario, Canada			B		X	X	X	Moderate bird activity; endpoint for streamed data, data management, and data fusion tools; main backup site; multiple radars (eBirdRad & AR1); wired & wireless (WiFi) LAN & WAN; RDS.

4.1 MCAS CHERRY POINT

Marine Corps Air Station, Cherry Point (MCASCP; 34°54'11.19"N, 76°53'16.20"W; Figure 4-2) is located along the coastal plain in Craven County, North Carolina, near the town of Havelock. MCASCP is roughly 90 miles (145 km) west-southwest of Cape Hatteras at the foot of the great Outer Banks. With an area of 5330 ha on the air station proper, MCASCP is the world's largest Marine Corps Air Station. It is home to the 2nd Marine Aircraft Wing and to Marine Air Group 14, the primary East Coast operating unit for the Marine Corps AV-8B Harrier (four squadrons) and EA-6B Prowler (four squadrons). The Air Station also host to four squadrons of KC-130 tankers and an Unmanned Aerial Vehicle (UAV) squadron.



Figure 4-2. MCAS Cherry Point, North Carolina, showing the location of the eBirdRad radar (RT-1) and the visual team (VT) observation sites used in the spring 2007 ('07) and fall 2008 ('08) studies.

We selected MCASCP as an IVAR study location because it is a large air station and it had two operational eBirdRad units that were being used to fulfill multiple research objectives. It was being used there to monitor waterfowl movements in the vicinity of the airfield and had been used to detect two previously unrecorded patterns of movements near dawn of large flocks of waterfowl and Double-crested Cormorants. The USDA/WS staff at MCASCP was also using the radar to observe known Wood Duck roosting areas during morning departure flights from the roost and to monitor waterfowl movements on the Neuse River during the winter months. In addition, the USDA/WS staff was comparing the data collected by visual observers during their

scheduled bird observations with the data logged by eBirdRad⁶. Their goal was to correlate the data from the two sources to determine the value of avian radars in developing airfield hazard evaluations.

A second eBirdRad unit at MCASCP was deployed to a proposed Outlying Landing Field site in Washington County, North Carolina (**Figure 4-3**). This location is approximately 175 km east of Raleigh, NC and 85 km northeast of MCASCP. The Department of the Navy was conducting flights of F-18 E/F Super Hornet aircraft at this location to measure sound levels while the aircraft flew the proposed OLF traffic pattern.



Figure 4-3. Site C at the Outlying Field (OLF) location in Washington County, North Carolina. The eBirdRad radar at the “OLF Site C (’06)” site was used to monitor bird activity near the location of a proposed runway, while the “Wildlife Refuge (’06)” eBirdRad radar was monitoring bird activity in the adjacent Pocosin Lakes National Wildlife Refuge. Data collected in February 2006 from these two radars were used by the IVAR project in its data fusion studies.

The USDA/WS personnel used eBirdRad units during this period to monitor bird activity at the proposed runway location and on the boundary of Pocosin Lakes National Wildlife Refuge. Information about birds tracked by the radar that were judged to be in the flight path or the aircraft was relayed in real time to the aircrew of the F-18 E/F during some of these operations. The eBirdRad unit was also used to investigate the movement of birds in the vicinity of the OLF site during spring and autumn migration, and during the over-wintering period. During February

⁶ The IVAR project used these same observations in the demonstration of Performance Criterion PB5.1 (Section 6.2.1.5).

2006 the primary eBirdRad unit from MCASCP was transported to the OLF location and used in conjunction with the eBirdRad radar already there. Data from these two radars were used in the IVAR data fusion studies (see Section 6.5.1.3).

4.2 NAS PATUXENT RIVER

NAS Patuxent River (NASPR; 38°17'11.71"N, 76°24'24.05"W; **Figure 4-4**) is located in the southern portion of St. Mary's County, Maryland, approximately 115 km southeast of Washington, DC. St. Mary's County is the southernmost part of Maryland's western shore and consists of a peninsula surrounded by tidal water on all but the northwestern boundary. NASPR occupies a smaller peninsula and broad headland (known as Cedar Point) at the confluence of the Patuxent River and Chesapeake Bay, in the eastern portion of the county. This main site, which comprises approximately 2713 Ha, is bounded by the Patuxent River to the north, the Chesapeake Bay to the east, and the town of Lexington Park, Maryland, to the south and west. NASPR is the Navy's principal research, development, test and evaluation (RDTE), engineering and fleet support activity for naval aircraft, engines, avionics, aircraft support systems and operations.



Figure 4-4. NAS Patuxent River, Maryland, showing the location of the eBirdRad radar (RT-1) and the visual team (VT) observation sites used in the spring 2007 ('07) and fall 2008 studies. VT site labels without a year designator were used in both 2007 & 2008.

We selected NASPR as an IVAR study location because it is a medium-sized air station, it had been the location of the eBirdRad acceptance testing, and the operational unit there was being

used in both the BASH and natural resources program. The eBirdRad unit had been used to document several patterns of seasonal and daily airfield bird movements, including vulture activity and concentrations of blackbirds, and this information was being passed to the tower and flight planning so pilots and aircrews were aware of the increased hazard during the times these birds were active. The eBirdRad unit was also being used by the natural resources managers at NASPR as a survey tool, mostly in areas of planned construction and particularly from dusk to dawn, when manual observations are limited by darkness.

4.3 NAS WHIDBEY ISLAND

NAS Whidbey Island (NASWI; 48°21'7.00"N, 122°39'19.01"W; Figure 4-5) is located on the northern end of Whidbey Island, in Island County, Washington, approximately 95 km northwest of Seattle. Situated between the Straits of Juan De Fuca and the Saratoga Passage and within the rain shadow of the Olympic Mountains, NAS Whidbey Island offers high quality year round training opportunities for naval aviators. The facility encompasses 1720 ha and has two 2440 m intersecting runways. The primary missions supported at NASWI are maritime patrol and electronic warfare, with logistic and search-and-rescue operations in a secondary role. The primary aircraft types using the airfield include the assigned P-3, EP-3, EA-6B, and H-60 along with extensive transient aircraft from various Navy and other military commands.

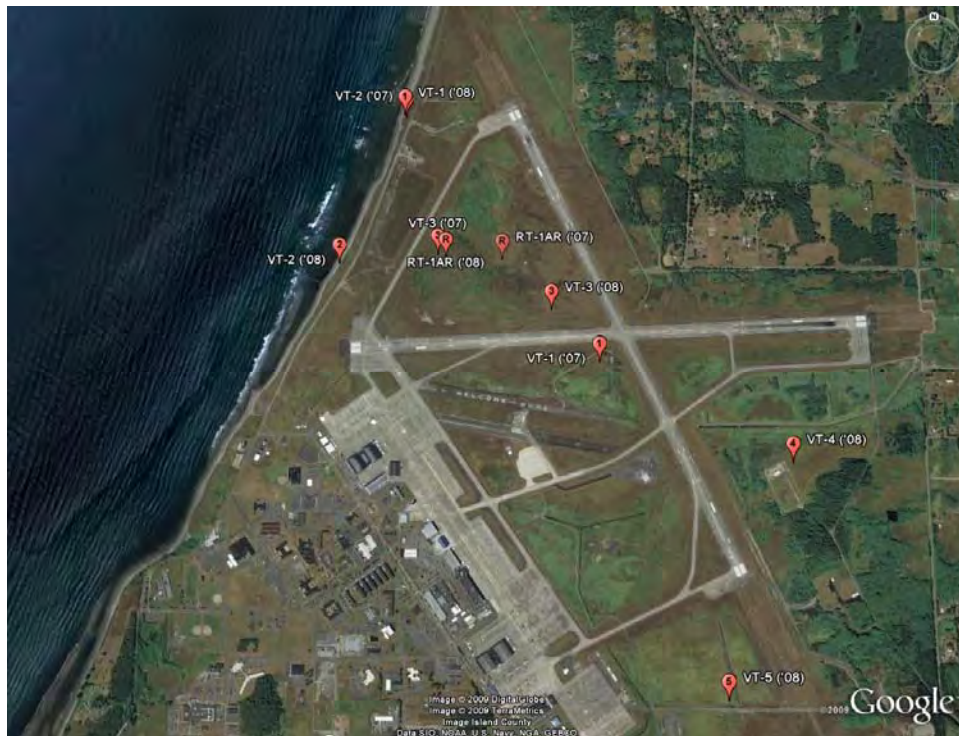

Figure 4-5. NAS Whidbey Island, Washington, showing the location of the eBirdRad radar (RT-1) and the visual team (VT) observation sites used in the spring 2007 ('07) and fall 2008 ('08) studies.

NAS Whidbey Island consistently has the highest number of bird targets of any of the IVAR study locations. It has an eBirdRad unit and a mobile AR-1 unit that are connected wirelessly (directional WiFi) to the Internet. In addition, data are also available for both avian radar units when they were previously connected to the Internet via a cellular network (EVDO).

We selected NASWI as an IVAR study location because it is a relatively small facility (1700 ha), it's along the Pacific Flyway, and it's the only IVAR location where the position of the radar has a largely unobstructed view of open water (i.e., Straits of Juan De Fuca) along its whole western boundary. In addition, the head of the Navy's BASH program has his office at NASWI and he was one of the first to receive an original BirdRad unit developed by Clemson University. Finally, while the IVAR project was in the planning stages, the CEAT project that was part of the IVAR team decided to place an AR17 avian radar at NASWI.

The NASWI staff was using an analog BirdRad unit before the IVAR project began, but even it had proven invaluable in providing avian flight pattern information to modify flight operations and manage natural habitats in and around the airfield in support of pilot safety. Screen-shot images showing large bird movements, particularly during evening and nighttime periods, were routinely saved and forwarded to the air wing safety officers, along with advisories to pilots and aircrews in anticipation of the same movement during the following nights. The biologists at NASWI were using the radar images to identify and locate feeding and roosting areas of birds on the airfield, which then led to the modification or removal of the attractant. They were also using the BirdRad unit in a cooperative research project with the Washington State Department of Natural Resources, studying Marbled Murrelets on their midnight feeding runs to the nearby bays.

The CEAT project is also using NASWI as a study location. **Figure 2-11** shows the CEAT AR-1 (WIAR1m) avian radar at NASWI that was used in the IVAR studies.

4.4 ELMENDORF AFB

Elmendorf Air Force Base (EAFB; 61°15'5"N, 149°48'23"W; **Figure 4-6**) is one of the most northerly US military airfields; it is also near the northern end of the Pacific Flyway for migratory birds. The base is immediately north of the town of Anchorage and encompasses 5,445 ha in its current configuration. Tall (1220 m) mountains exist to the east and south of the base, and on the north and west it is bordered by wetlands and open water (Cook Inlet). Coastal bird migrations follow Cook Inlet and pass over the EAFB/Anchorage land mass as they divide and head inland to interior flyways or through mountain passes into Prince William Sound and the coastal flyway. The unimproved grounds within the base boundaries include forest, shrub, and wetland habitats. EAFB is the largest Air Force installation in Alaska and home of the Headquarters, Alaskan Command (ALCOM), Alaskan NORAD Region (ANR), Eleventh Air Force (11th AF) and the 3rd Wing of the Eleventh Air Force.

⁷ A commercial avian radar developed by ARTI that is functionally equivalent to eBirdRad, but is nominally delivered with an array antenna, verses the dish antenna of the eBirdRad units.



Figure 4-6. Elmendorf Air Force Base, Alaska, showing the location of the eBirdRad radar (RT-1) and the visual team (VT) observation sites used in the fall 2008 ('08) studies.

We chose EAFB as an IVAR study because the natural resources management staff there had been very active users of their BirdRad unit. The inclusion of EAFB also gave us study locations at Navy, Marine Corps, and Air Force facilities: The services with the most active BASH programs in DOD. EAFB is a large facility, along the Pacific/coast flyways, near the Arctic Circle and the northern extent of the boreal forest biomes. Thus, it provided a different physiographic setting from the temperate locales of the other facilities.

Elmendorf AFB is also noteworthy in another regard: it was there, on 23 September 1995 that an Air Force AWACS aircraft collided with a flock of Canada Geese on takeoff and crashed, killing all 24 persons onboard. This event, more than any other, led to the expansion of DOD's active BASH programs to reduce or eliminate bird strikes at military airfields.

As was the case at NASWI, Elmendorf was still using an analog BirdRad radar when the IVAR project began. Soon after the BirdRad was delivered in the fall of 2002, the BASH staff used it to document the high concentrations of bird activity during the post-sunset periods of the fall migration. They brought these patterns, along with a number of "near misses" between birds and aircraft, to the attention of air operations personnel, who then modified flight operations to avoid the periods of highest birds activity (i.e., post-sunset and pre-dawn).

The environmental staff at EAFB also used the BirdRad unit to document additional patterns of bird activity at or near the base, including:

- A pronounced bi-modal distribution of bird concentrations over two years of spring and fall migration samplings.

- Large (several thousand) flocks of Bohemian waxwing in the Anchorage-Elmendorf area during the winter months, when bird activity was thought to be low. [This observation led to new regulations to minimize berry-producing trees and shrubs in the bird exclusion zone around the airfield by 2015.]
- Large flocks of ducks (later identified to be scoters) leaving Cook Inlet during the spring, crossing the airfield, climbing through the adjacent mountains and heading presumably toward interior Alaska in a probable pre-nesting movement.
- Owls frequently flying along the runways at night, apparently hunting voles and shrews.
- Juvenile bald eagles taking advantage of rising thermals coming from the runway surface as they learn to fly in the fall.
- The juxtaposition of the Municipality of Anchorage land fill and the preferred nesting sites of herring gulls on warehouses near the mouth of Ship Creek putting their feeding routes across the approach end of Runway 02.

These observations had also piqued the interest of local bird biologists from USFWS and USGS-Biological Resource Division (BRD) – so much so that they had become willing participants in manning the radar to build the migration database. Personnel from BRD subsequently submitted proposals to DOD-Legacy to evaluate the predictability of migration strength based on weather (wind and cloud cover) and to incorporate this model with NEXRAD data to develop a south-central Alaska bird avoidance model based on time of year and weather.

4.5 SEATTLE-TACOMA INTERNATIONAL AIRPORT

Seattle-Tacoma International Airport (SEA; 47°26'36.96"N, 122°18'11.04"W; **Figure 4-7**) is a commercial airport located in southern King County, Washington, approximately halfway between the cities of Seattle (21 km north) and Tacoma (24 km south). Including clear zones around the airport, SEA comprises 1090 ha in land area. The airport is a major hub of air travel to and from the western United States and the Pacific Rim, with more than 32M passengers and 290K metric tons of cargo on nearly 345K aircraft operations in 2008.

The CEAT project installed an AR2 digital avian radar unit (see **Figure 2-9**) at SEA in July 2007, and these two units have been streaming real-time radar track data ever since. This is a dual-radar system configuration, with the two radars designated SEAAR2u (upper position in rack) and SEAAR2l (lower position in rack). The CEAT project subsequently added a mobile AR1 radar (SEAAR1m) in September 2008; it too is configured to continuously stream data to a remote RDS and to notebook computers carried by the wildlife managers in their vehicles.



Figure 4-7. SEATAC International Airport, showing location of the AR2 avian radar.

We chose SEA as an IVAR study location because the CEAT project was planning to install a dual-radar AR2 system there and to continuously stream data from both of these radars to a remote RDS. It therefore offered an ideal location for the project's planned data streaming, data integration, and data fusion demonstrations. In addition, the wildlife management staff at SEA had already undertaken independent studies of raptor activity at SEA using radio-collared Red-tailed Hawks (Anderson & Osmeck, 2005). This offered the potential of another form of track validation, track birds both with their radio tags and with an avian radar.

4.6 EDISTO ISLAND

Edisto Island (32°33'42.21"N, 80°17'50.98"W; Figure 4-8) is located in Charleston County, South Carolina, 42 km southwest of the city of Charleston. The island is in the Sea Islands Coastal Region of South Carolina and has a population of approximately 2600 people. The IVAR study site is on private property owned by two of the IVAR team members (Sid Gauthreaux, Jr. & Carroll Belser), approximately 5 km from the Atlantic coastline, in a low-lying area of *Spartina* marsh, mixed forests, and farmlands.

We chose Edisto Island as the primary location to conduct the validation studies using thermal imagery (see Section 6.1.1.2) because it has large populations of resident and migratory birds, including many waterfowl. It is also a well-studied location, being the home of two of the world's best known radar ornithologists, Sid Gauthreaux, Jr. and Carroll Belser, and one on which the IVAR team had complete freedom of movement. In addition, because of the high levels of seasonal bird activity in the area, Edisto Island was considered a good candidate

location for demonstrating the capacity of eBirdRad to track large numbers of birds simultaneously.



Figure 4-8. Clemson: Edisto Island location, SC showing the planned site for the TIVPR unit.

4.7 ACCIPITER RADAR TECHNOLOGIES, INC.

The corporate offices of Accipiter Radar Technologies, Inc. (ARTI; 43°02'31.67"N, 79°20'23.77"W; **Figure 4-9**), a Sicom Company, are located near the town of Fonthill, Ontario, Canada. This location is at the center and high-point of the Niagara Peninsula, approximately mid-way between Lake Erie and Lake Ontario, and 50 km northwest of Buffalo, New York. The ARTI facility is situated on a 2 Ha parcel in a rural setting, with agricultural lands (cherries and grapes) to the immediate east and west and recreational lands to the immediate north and south. Local birds include Canada Geese, Turkey Vultures, gulls, and hawks. The site is also along a major migration route, where it is hoped that with the radar running continuously, we will be able to capture these seasonal movements.



Figure 4-9. ARTI, showing location of radar tower near corporate offices.

We designated ARTI as the “operations center” for the IVAR data streaming and data fusion/integration demonstrations. We elected to locate the Radar Data Server (RDS) there to serve as the destination for streaming, storing, and redistributing data to other sites and applications, including the Radar Fusion Engine (RFE). ARTI also has locally installed radars, including an eBirdRad with both wired and wireless links to the RDS.

5 TEST DESIGN

5.1 CONCEPTUAL TEST DESIGN

This section describes the tests we designed to demonstrate the six project objectives of the IVAR project, as described in Section 1.2 and **Table 3-1**. **Figure 2-7** provides a diagrammatic representation of the major components of the avian radar systems the IVAR project used to demonstrate those stated objectives. For conveniences, Figure 2-8 summarizes in a single diagram how all of these components might be deployed in an operational environment: In the actual tests, we deployed different combinations of components at a single location, while other situations required communications between components at several facilities.

Section 5.4 organizes the design of the tests the IVAR project developed to evaluate avian radar systems into categories based on the major performance objectives listed in Table 3-1, which are in turn derived from the user requirements summarized in **Table 1-1**. At the highest level, these tests were designed to answer three fundamental questions about the avian radar systems that are on the market today (or at least those evaluated by this project):

Do they perform as advertised? Digital avian radar systems are relatively new technology (**Figure 2-1**). They were not developed following conventional “build-to-spec” protocols, nor are there any “industry standards” for these systems. In short, most of what a potential end-user might want to know about these systems came from vendor literature or anecdotal observations. Thus, the first high-level grouping of the tests the IVAR project designed asked the fundamental question: what are the capabilities of digital avian radar systems? In particular, are the targets the software is tracking really birds? Can they track birds in real time? At what range, through what field-of-view, and to what altitude can these systems reliably track birds?

Can they perform under real-world conditions? Given these systems perform as advertised, can they do so continuously and reliably, 24/7, in different geographic regions, by personnel with little or no prior experience? Can they be operated automatically and remotely? How many birds can they track at once and are they likely to detect at least as many birds as a human observer would? Can multiple radars be operated simultaneously to cover large facilities?

Can they deliver the data where, when, and in the form they are needed? What types of data will be available for each target, and will they be available in real time? How can those data be presented to the users: visually, graphically, in tabular form, and/or exported to third-party products? Can the real-time data be reliably streamed across a network and stored in a database for redistribution and/or historical analysis? Can tracks from multiple radars be integrated into a common display or fused into common tracks? Can alarms be set to notify users when an event occurs, without having to constantly monitor the radar?

A fundamental design question was raised early in the IVAR project, one that pertains to radars in general; namely, the probability a radar can detect a real target that is present in the radar beam, or conversely, the probability that noise, clutter, or other factors can cause the radar to report the detection of a target that isn't really there - a “false detection”. This issue is a particularly important issue for avian radar systems because birds are small, highly maneuverable, and poor radar reflectors. In order to detect and track as many birds as possible,

the threshold for filtering out background noise is usually set low in the DRP, which in turn increases the probability of false detections and potentially false tracks.

Given the importance of this topic to the performance characteristics of digital avian radar systems, we conducted an analysis that examined the applicability of using probability of detection (P_D) and probability of a false alarm (P_{FA}) for characterizing avian radar perform. We chose instead to use maximum firm track range (FTR) as both appropriate and practical for the real avian radar systems being used and for the users of those systems.

5.2 BASELINE CHARACTERIZATION AND PREPARATION

Section 4 describes the IVAR study locations. The demonstrations conducted at the principal locations involved different aspects of validating that digital avian radar systems can automatically sample the bird populations residing at or visiting those locations. The demonstrations we designed did not compare before-and-after conditions at those locations; thus, they did not require characterizing the baseline conditions before the studies were undertaken.

The IVAR project, however, relied heavily on expert knowledge of the avifauna at each of the study locations when designing the field studies, in particular the visual and thermal confirmation studies (Sections 6.1.1.1.1 and 6.1.1.1.2). This expertise was provided by the resident wildlife biologist at each of the six principal IVAR study locations, each of whom was in turn a member of the IVAR project team. These IVAR team members include:

<u>Study Location</u>	<u>Resident Wildlife Biologist</u>
NAS Patuxent River	Jim Swift
MCAS Cherry Point	Mike Begier/Chris Bowser
NAS Whidbey Island	Matt Klope
Elmendorf AFB	Herman Griese
Edisto Island	Sid Gauthreaux
Sea-Tac International Airport	Steve Osmek
(Overall)	Bob Beason

Each of these individuals was instrumental in choosing when to conduct the visual and thermal confirmation studies at these locations, so as to coincide with periods of peak bird activity there, and where to position observers at those locations to cover as much of the study area as possible. IVAR Method #3 (Appendix B) describes the criteria and methods for selecting the visual confirmation sites at a location.

The avian radars used in the IVAR studies were already in operation before the studies began⁸, and all of the requisite siting and operational approvals had been obtained. Thus, no site preparation was required, save for the layout of the Visual Team (VT) sites as described in IVAR Method #3 (Appendix B). Similarly, these radars will continue to operate after the IVAR project is complete and thus no site teardown was required.

⁸ Two locations, EAFB and Edisto Island, had operational BirdRad radars that were upgraded to eBirdRad units during the IVAR project.

5.3 DESIGN AND LAYOUT OF TECHNOLOGY AND METHODOLOGY COMPONENTS

Figure 2-7 provides a schematic representation of, and Section 2.4.3 a description of, the major components of the avian radar systems evaluated by the IVAR project, including:

- Automated Radar Scheduler, ARS (page 20)
- Digital Radar Processor, DRP (page 17)
- Network connectivity (page 20)
- Radar Data Server, RDS (page 17)
- Radar Fusion Engine, RFE (page 20)
- Radar Remote Controller, RRC (page 20)
- Radar Transceiver, RST (page 14)
- TrackViewer® Workstation, TVW (page 17)

Figure 2-8 is notional representation of how these components might be deployed at an operational site; the actual location of these components (principally, the RST & DRP) at the IVAR study locations is described in the subsections of Section 4. Additional information about the location of and interaction between the components is provided in the Performance Criteria write-ups in Section 5.6, as appropriate.

5.4 FIELD TESTING

Because the avian radar systems evaluated by the IVAR project were already operational when the field testing began, many of the demonstrations could be performed using data that were, or could be, collected during of their routine operation. Only the demonstrations of automatic tracking were time-sensitive and required advanced scheduling – to coincide with spring and fall migrations at the facilities on the east and west coasts. The automatic tracking field tests involved deploying teams of observers to the study locations without setup and shutdown of the radar systems per se.

The descriptions in this section provide background to and an overview of the tests that were performed for each of the five major performance objectives: Automatic Tracking, Sampling Protocols, Data Streaming, Data Integration, and Data Fusion. Where appropriate, a cross-reference is provided at the end of these descriptions to the Performance Assessment subsection that contains the detailed objectives, methods, results and conclusion for that test.

Automatic Tracking

The core question addressed by this objective is whether software can automatically detect and track birds as well as or better than a trained radar ornithologist observing the same returns on an analog radar display. Moreover, because avian radars were originally developed by adapting radars built for other purposes (i.e., they were not “built-to-spec”), a more fundamental question needed to be answered first: Are the targets the human observers – and now the automatic algorithms – tracking really birds? Before the IVAR project, there had been few published attempts to “ground truth” analog avian radars (Burger, 1997), and none for digital systems. Consequently, the IVAR project set as its first test of the automatic tracking capabilities of avian radars the ground-truthing of the targets. We proposed to carry out these ground-truthing studies

at several geographic locations and at different times of the year to sample differences in species abundance, physiography, weather conditions, etc.

The best judge of whether a target being tracked by a radar is a bird is a human observing the same target visually. On the other hand, several members of the IVAR team who participated in previous informal “visual confirmation” studies reported these observations were subject to a long list of confounding factors: the short period of time the bird may be in the radar beam; not knowing the precise location of the radar beam relative to the observer; the difficulty of judging distances when looking up at the sky; differences in the bird-to-background contrast due to the bird’s coloration, weather conditions, light levels, sun angle; the fact that radar can detect birds at far greater distances than the human eye, even with the aid of binoculars or a spotting scope.

Based on these considerations, the IVAR team chose to use multiple ground-truthing methods and the different lines of evidence they produce to confirm the targets the digital radar tracks are birds. These ground-truthing methods included:

Visual Confirmation – at four geographic locations and both during the spring and fall, deploy teams of visual observers at various ranges and azimuths from the radar during the daylight hours and ask them to confirm visually whether a target that was being tracked by the radar was a (flock of) bird [Section 6.1.1.1.1].

Thermal Confirmation – use a thermal imager, which can detect the heat signatures of biological targets, to confirm that the targets tracked by both the imager and the radar at night are birds [Section 6.1.1.1.2].

Unmanned Aerial Vehicle (UAV) – fly a remote-control helicopter with a recording GPS in the radar beam to simulate the flight path of a bird and then compare the spatial coordinates from the GPS with those of the avian radar [Section 6.1.1.1.3].

Synthetic Targets – input software-generated target data, with known attributes and flight dynamics, to the radar’s DRP and compare the radar tracks with the programmed characteristics of the targets [Section 6.1.2.1].

Image Comparisons – capture screen images of the same scene generated by an analog avian radar and a digital avian radar to determine how closely the digital renderings of the scene match those of the analog display [Section 6.1.2.1].

Table 5-1 lists the locations, types, and dates of the field tests conducted to demonstrate the automatic tracking capabilities of the avian radar systems deployed at these facilities.

Table 5-1. Dates and types of field tests of automatic tracking.

Location	Test Type	Study Dates	
MCAS Cherry Point, North Carolina	Visual	Mar-Apr 2007	Oct 2008
NAS Patuxent River, Maryland	Visual	Apr 2007	Sep 2008
NAS Whidbey Island, Washington	Visual	Apr 2007	Sep 2008
Elmendorf AFB, Alaska	Visual		Aug 2008
Edisto Island, South Carolina	Thermal		Oct 2008
Sea-Tac International Airport, Washington	UAV		Sep 2008

Assuming these lines evidence confirmed that digital avian radars can automatically track birds, we devised the following tests to demonstrate the additional capabilities and benefits of the automatic real-time tracking capabilities of the digital avian radar systems evaluated by the IVAR project:

Parametric Data – document the types of parametric data, particularly the 4D spatial-temporal coordinates, digital avian radars can generate for each tracked target during each scan of the radar [Section 6.1.1.2].

Number of Simultaneous Targets – demonstrate the software can simultaneously track a realistic number of targets [Section 6.1.1.3].

Representative Ranges to Targets – confirm that the radar system can sample targets over distances that would include most military bases and ranges [Section 6.1.1.4] and beyond [Section 6.1.1.5].

Sampling Protocols

Before avian radar systems can be used to augment other methods of sampling birds, it was necessary to demonstrate that they can operate in the locales and under the conditions in which they would be expected to perform. Specifically, we designed tests to demonstrate that the digital avian radar systems IVAR evaluated could:

Coverage – in addition to sampling over ranges that would encompass most military facilities (see above), sample through 360° of azimuth [Section 6.2.1.2], up to altitudes at which birds are known to fly [Section 6.2.1.6], out to the “near” distances (i.e., 11 km) [Section 6.2.1.3], and do so continuously night and day [Section 6.2.1.1].

Storage – record on conventional COTS mass storage devices the amount of data generated during these periods of continuous operations [Section 6.2.1.4].

Sample More Birds – count more birds than a conventional sampling method during the same time period, plus count more birds overall because the avian radar can sample 24/7, while most conventional sampling methods cannot.

Data Streaming

Having established that the digital avian radars the IVAR project evaluated could automatically detect and track birds under typical operating conditions, we then devised a series of tests to demonstrate that those data can be reliably delivered where they are needed, in near-real time, and in a form that has value for the end-users. These tests were designed to:

Network Availability – demonstrate that the availability of wireless [Section 6.3.1.7] and wired [Section 6.3.1.2] LANs and wired WANs [Section 6.3.1.6] is high enough both within and between locations to deliver the requisite plots & tracks data for local, remote, and historical applications.

Network Reliability – demonstrate that the data can be delivered intact to the end-user applications [Section 6.3.1.1].

Storage & Redistribution – demonstrate that the data can be streamed to a database and redistributed in near-real time to other users and applications without little or no loss in data quality [Section 6.3.1.3].

End-Use Applications – demonstrate various potential applications for the data to natural resources management and aircraft safety personnel [Sections 6.3.1.4 and 6.3.1.5].

Data Integration

Data integration involves displaying the tracks from two or more radars on a common display, whether or not those radars have overlapping coverages. Data integration, like data fusion, increases the situational awareness of the operating environment by combining the tracks from different radars into a common operational picture (COP). Depending upon the location and orientation of the radars, combining track data may increase the area being sampled, reveal targets that were hidden from the view of the other radar(s), or both. Integration simply presents the tracks from multiple radars on a common display; thus, the beams of the radars need not overlap. Fusion, on the other hand, replaces the tracks from the areas of overlap with common tracks, and thus can increase not only coverage, but also track continuity.

Synchronized Coverage – we designed two demonstrations of data integration: One to show that the displays from two radars widely separated in space could be displayed side-by-side without introducing significant time-lags (latencies) between the two [Section 6.4.1.1] and a second that the displays could be merged into a common display (COP) without significant latencies between the COP and the separate displays [Section 6.4.1.2].

Data Fusion

Data fusion involves two (or more) radars with beams that overlap, at least partially. The fusion process makes a determination as to whether the tracks from the two radars in the area of overlapping coverage are sufficiently well aligned in space and time to represent the same target, and if so, it combines those tracks into a common track. Tracks that are outside the area of overlap, plus those that are within the area of overlap but are not well aligned are displayed separately in the COP (i.e., they are integrated rather than fused).

A major challenge in this area derives from the fact that even though the radars are nearby and have overlapping beams, they are still independent: They are not synchronized temporally (they have independent time sources) or spatially (they rotate independently and asynchronously and are displaced in space). We designed a series of three tests to demonstrate that these challenges notwithstanding, the outputs from two independent radars can be reasonably aligned in time and space to provide meaningful improvements when their radar tracks are combined through integration (Section 6.4) or fusion (Section 6.5). These three tests were:

Spatial Alignment – demonstrating that two asynchronous radars can be spatially aligned within acceptable error to provide meaningful target data for fusion. To test this, we computed the misalignment error for each pair of radar tracks and specified that this error must be less than three times the a priori spatial uncertainty [Section 6.5.1.1].

Temporal Alignment – demonstrating that two asynchronous radars can be temporally aligned within acceptable error to provide meaningful target data for fusion. To test temporal alignment, we specified that the time sources for these two radars must not vary from one another by more than 5 seconds over the course of one week [Section 6.5.1.2].

Data Fusion - demonstrating that the fusion algorithms used in the radar fusion engine (RFE) evaluated by the IVAR project can be applied in near real time and presented in a single operator display with the duplicate tracks consolidated. We specified that the time to process and consolidate the tracks from paired datasets must be less than the actual time interval of

that dataset [Section 6.5.1.3].

5.5 SAMPLING PROTOCOL

The IVAR project developed or modified six methods to gather the data that were used to evaluate the performance criteria established for avian radar systems. These six methods are briefly described below; see Appendix B for a detailed description of each method.

Method #1: Validation by Simulation (page 297): This method was a modification of a method used by ARTI to evaluate the accuracy of target tracking algorithms. We used an in-house software simulation tool to generate a plot file with sequences of detections that were consistent with avian target dynamics. The plot file was then replayed through a DRP for off-line re-processing (i.e., re-tracking), and the resultant tracks compared with the known dynamics of the targets generated by the software.

Method #2: Validation By Image Comparison (page 299): This method was used to compare the analog and digital rendering of the same scene by the BirdRad and eBirdRad radars. It involved splitting the analog video waveform from a Furuno 2155BB radar operating in the field at MCAS Cherry Point and feeding the same data stream to both the analog electronics that come with the Furuno radar and to the Accipiter® digital radar processor (DRP). The two images were displayed on separate monitors and screen-capture software was used to copy these images for subsequent visual comparison.

Method #3: Visual Confirmation Of Bird Targets (page 302): This method was developed by the IVAR project to determine whether the targets being tracked by an avian radar were in fact birds (i.e., “ground-truthing” the radar targets). It involved deploying two-person teams of visual observers at different distances and angles from the avian radar during a series of 2-hour sessions conducted during the morning, mid-day, and evening at the IVAR study locations. The radar and visual observer teams were in communication with one another via two-way radios. During the “RT-Calls” scenario the radar team would select a target being tracked by the radar and radio to the visual team closest to the target the distance, bearing and heading of the target relative to the visual team’s position, and ask if the visual team could confirm whether the target was a bird. Other visual teams that could see the target could also call in a confirmations. In the “VT-Calls” scenario a visual team that observed a bird they thought was in the radar beam could call the radar team on the radio and give them the target’s distance, bearing and heading from their position and ask if the radar was tracking that target.

Method #4: Confirmation Of Bird Targets Using Thermal Imaging (page 319): This method was a modification of methods developed by Gauthreaux and Livingston (2006). We used it to confirm targets being tracked by the avian radar at night were birds. The equipment included a vertically-pointing thermal imaging camera and a vertically-pointing X-band radar: The former was used to identify the heat signatures of biological targets passing above the camera; the latter was used to measure the height of those targets. This Thermal Imager - Vertically Pointing Radar (TI-VPR) unit was placed at different distances from the avian radar system and the recordings of tracks from the TI-VPR were correlated to tracks from the avian radar as its beam passed over the TI-VPR.

Method #5: Automatic Tracking Of Unmanned Aerial Vehicles (page 330): This method was developed by the CEAT project to measure the accuracy of the longitude, latitude, and height coordinates computed by the avian radar system for targets it tracks. The method consisted of

flying a remotely controlled helicopter (RCH) with an onboard recording GPS through various maneuvers while tracking it with an avian radar. The spatial and temporal coordinates recorded for the RCH were then compared to those recorded by the avian radar as it tracked the RCH.

Method #6: Demonstrating Real-Time Data Fusion (page 331): These methods were developed by the IVAR project to determine if it was possible to fuse the real-time tracks from two or more avian radars into common tracks in the areas of overlap between the radar beams. This method consists of three related analyses: Spatial Alignment to determine if the spatial misalignment error is markedly smaller than the *a priori* spatial uncertainty of the radar; Temporal Alignment to determine if the temporal misalignment between the radars is less than twice the radars' scan period; and Fusion Processing to determine if the time required by the fusion engine to process and fuse the tracks from multiple radars is equal to or less than the real-time duration of the paired track data.

5.6 SAMPLING RESULTS

The sampling results from the IVAR validation studies are included in the Performance Assessment write-up of each test (Section 6) or, in some cases, in Appendix D.

6 PERFORMANCE ASSESSMENT

The Performance Criteria in this section are first organized by Project Objective and within each Project Objective they are broken down quantitative metrics with criteria and into qualitative metrics with criteria.

6.1 AUTOMATIC TRACKING

6.1.1 Quantitative Performance Criteria

6.1.1.1 Tracks Single Birds and Flocks [PA1.1]

Objective

Our objective in establishing Criterion PA1.1 was to demonstrate that some of the radar echoes eBirdRad is capable of automatically detecting and tracking are birds⁹. We proposed to use visual and thermal confirmations to validate radar’s ability to auto-track birds, and to use a UAV to independently confirm a target’s spatial coordinates. The Success Criterion [Table 3-1] for PA1.1 was that the eBirdRad system could automatically detect and track 100 or more targets (single birds or flocks) that human observers could visually confirm them to be birds during daylight hours at each of three geographic locations (Section 6.1.1.1.1). We further proposed to use thermal imaging observations at night to confirm 100 or more targets as birds at one or more geographic locations (Section 6.1.1.1.2). Finally, we proposed to use the Digital Radar Processor (DRP) to track an Unmanned Aerial Vehicle (UAV) with an onboard recording GPS device that could be used to independently verify the spatial and temporal coordinates generated by the avian radar for a target (Section 6.1.1.1.3).

The Methods, Results, and Conclusions from these three demonstrations are discussed separately below. Section 6.1.1.1.4 provides summary conclusions for all three demonstrations.

6.1.1.1.1 Validation by Visual Confirmation

Methods

We have included a detailed description of the methods the IVAR team developed for visually confirming targets being tracked by avian radar in Appendix B. The IVAR team employed those methods in the spring of 2007 and the fall of 2008 to conduct visual confirmation studies at the four geographic locations listed in Table 6-1.

Table 6-1. Locations of spring 2007 and fall 2008 IVAR visual confirmation studies.

Location	Study Dates		Position of Sites
MCAS Cherry Point, North Carolina	Mar-Apr 2007	Oct 2008	Figure 6-1
NAS Patuxent River, Maryland	Apr 2007	Sep 2008	Figure 6-2
NAS Whidbey Island, Washington	Apr 2007	Sep 2008	Figure 6-3
Elmendorf AFB, Alaska		Aug 2008	Figure 6-4

⁹ In addition to birds, eBirdRad regularly detects and tracks other mobile biological targets that include bats, insects, and blowing seeds, plus inanimate objects such as cars, airplanes, and boats.

The spring 2007 studies at the Cherry Point (**Figure 4-2**) and Patuxent River (**Figure 4-4**), as well as the fall 2008 study at Elmendorf AFB (**Figure 4-6**), used eBirdRad avian radars with a 4° parabolic dish antenna, nominally set at 4°-10° above horizontal. The 2007 study at Whidbey Island (**Figure 4-5**) employed an AR-1 avian radar with a 20° array antenna¹⁰; the 2008 study at Whidbey Island used both an AR-1 and an eBirdRad unit.

At each location, “Visual Team” (VT) observation sites were selected around the facility, with one VT site in each quadrant around, and at different distances from, the radar where possible. Two-person teams were assigned to a subset of the VT sites during each 2-hour session, depending upon how many personnel were available for that session. One member of each team was the visual observer: This person attempted to locate and identify the targets called out by the Radar Team. The other team member recorded the observation data on a field data form. Similarly, a two-person “Radar Team” (RT) was assigned to the radar trailer: The radar operator observed the targets being tracked on the DRP display, while the other team member recorded on field data sheets information about the tracked targets that was called out by the radar operator. The Radar and Visual Teams had two-way radios with which they could communicate with one another.

In addition to the manually recorded VT and RT field data, copies of the digital “plots and tracks” data files generated by the DRP during each session were saved for later analysis. A 5-10 minute segment of raw digital data was also saved during each session should questions arise later regarding the radar’s performance during that session.

Two and occasionally three 2-hour sessions were scheduled each day of a study. The goal was to have an equal number of morning, mid-day, and evening sessions; the actual time of the sessions depended on the season and latitude of the study location. During the initial, spring 2007 studies, only “RT-Calls” observations were made. In this scenario, the radar operator would follow tracks on the DRP display and select one as a good candidate based on a variety of criteria, including: the duration of the track, the separation from other targets with which it might be confused, whether the nearest VT likely had an unobstructed view of the target, etc. The radar operator would then broadcast a Request for Confirmation (RFC) to the VT that was in the best position to observe the selected target. The broadcast would include the bearing and distance of the target from the specified VT site. The radar operator would also activate the image-capture function of the DRP to save a digital picture of the radar display when the RFC was called.

If the specified or another VT observed a target that matched the position broadcast by the RT, they would broadcast a confirmation to the RT and record the time, position, quantity, and species of the observed target. If no team confirmed the specified target, the RT would cancel that RFC, record it as a non-confirmation, and proceed to the next target.

“VT-Calls” observations were added to the visual confirmation methods in the fall 2008 studies. In this scenario, if a VT observed a bird they thought was in the radar beam and no other RFC was in effect at that time, they could broadcast an RFC to the RT, including the estimated bearing and range from their position to the target. If the RT could match the broadcast description to a target being tracked by the radar, the RT would broadcast a confirmation and

¹⁰ The effective coverage of the 20° antenna is 10° above the horizontal; the other half the beam is below the horizontal (i.e., into the ground).

record the time, Track ID, and other parameters on their field data sheet. Otherwise, the RFC was recorded as a non-confirmation.

Another procedural change made during the fall 2008 studies was to have the visual observers return to the same VT sites for each session during a study. This was done in expectation that it would eliminate one variable – familiarity with the environment at the site, especially the location of the radar beam above the site – from the challenging task of visually confirming birds tracked by the radar.

At least one member from each team participated in a post-processing meeting immediately after the field sessions. At these meetings the teams compared the information on their respective field data forms for consistency. It was critical that RFCs were recorded consistently and accurately by all the teams. The RFC Number was the key to linking the VT's visual observation of a target on the wing with the RT's observations of the track for that target on the radar display. The unique Track ID of a target called in an RFC was also recorded on the RT data forms. It provided the link between the RT and VT observations of the targets and the data recorded in the digital plots and tracks files generated by the DRP.

During these post-processing sessions the field data sheets were sometimes updated (and so-annotated) to reflect results of RFCs other than “Y” for Confirmed or “No” for Not Confirmed. The other outcomes of an RFC included: “A” – the RFC was Aborted before a team had time to confirm the target; “H” – the team to which the RFC was directed did not Hear the broadcast, usually because of noise from passing aircraft; “O” – for Other events that interfered with the completion of the RFC (e.g., the DRP was accidentally unplugged after an RFC was broadcast). Only RFCs recorded as “Y” or “N” were used in the computation of the Success Criterion for visual confirmations.

The field data were subjected to extensive quality control procedures during and after they were transcribed from the hardcopy field forms into a relational database. The field observations were also checked against two types of radar data: The digital picture that was captured when each RFC was broadcast, and by replaying the plots and tracks data for that time period to ensure the radar and visual observations were consistent.

Results

Table 6-2 summarizes the results of the IVAR visual confirmation studies. Fifty 2-hour sessions were conducted at a total of 34 separate visual observation sites located at the four geographic study locations. Visual observers confirmed targets over horizontal distances that ranged from 0 to >5100 meters (0-17,000 feet; see also 6.1.1.5) and through 360° of azimuth (see also 6.2.1.2). The visual observers identified the 1531 confirmed targets as belonging to 65 separate taxa, with the most frequently observed taxa being gulls (Subfamily Larinae), Turkey Vultures, and Double-crested Cormorants. Approximately half (841) of the targets were single birds; the remainder (702) were flocks of two or more birds. Of the 1531 total confirmation tracks, 132 were confirmed by two or more Visual Teams.

Table 6-2. Summary of the results from the visual confirmation of birds tracked by avian radar.

Location	Study	Sessions	VT Sites	Requests for Confirmation			
				Total ⁽¹⁾	Confirmed		
				No	Yes	% Yes	
MCAS Cherry Point	Spring 07 ^c	12	9	675	261	384	60%
	Fall 08 ^c	6	4	105	34	63	65%
NAS Patuxent River	Spring 07 ^e	6	5	485	139	334	71%
	Fall 08 ^c	5	4	99	23	75	77%
NAS Whidbey Island	Spring 07 ^a	7	3	381	180	197	52%
	Fall 08 ^{a,c}	8	4	738 ⁽²⁾	238	442	65%
Elmendorf AFB	Fall 08 ^c	6	5	116	69	36	34%
TOTAL		50	34	2632	944	1531	62%
MEAN							61%

^e – eBirdRad avian radar with 4° parabolic dish antenna; ^a – AR-1 avian radar with 20° array antenna

(1) Total responses to Requests for Confirmation (RFC) include Yes, No, Abort, did not Hear, and Other. Only Yes & No responses were used to compute "% Yes".

(2) Both the eBirdRad and AR-1 radars were operated at the same time at NAS Whidbey Island during the fall 2008 study, but we only called RFCs from one radar at a time. Sixty-eight of the Total RFCs were called from the eBirdRad radar, with a dish antenna; the remaining 670 were called from the AR-1, with an array antenna. The eBirdRad radar transceiver was experiencing reduced sensitivity at the time of the 2008 study, and after the IVAR study was complete, the transceiver was repaired. The 68 eBirdRad RFCs had the following confirmation statistics: Y=19; N=41; A=7; H=1.

Visual observers confirmed as birds more than 100 targets tracked by radar at each of the three locations sampled during the spring 2007 studies (**Table 6-2** and **Figure 6-1**). The combined total of confirmed targets that year was 915. In the fall 2008 the combined total of targets confirmed at the four locations was 616. NAS Whidbey Island was the only location to have more than 100 targets confirmed in 2008; it was also the only location that year that had appreciably more than 100 total RFC broadcasts (Figure 6-2). The number of confirmed targets at Whidbey Island in 2008 (442) was greater than the combined total of all called targets (320) at the other three locations.

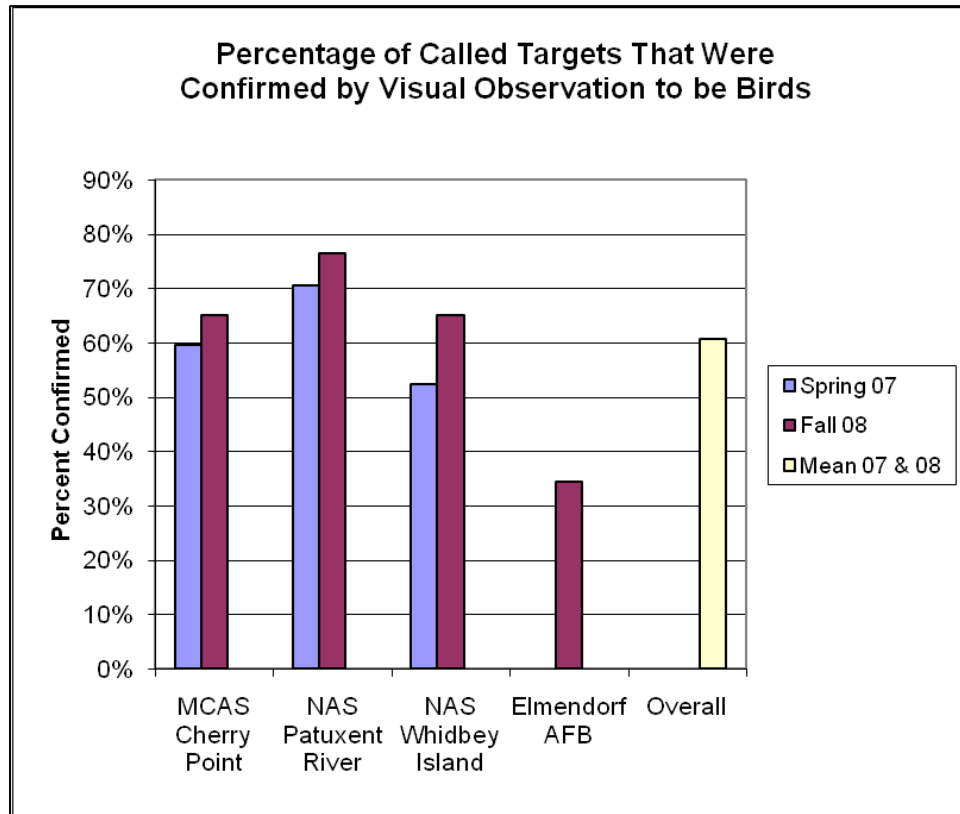

Figure 6-1. Percentage of targets called in a Request for Confirmation that were confirmed to be birds by visual observation.

The paucity of birds during the fall 2008 studies is also evident in the results from the visual observers, who were encouraged to initiate their own RFCs (“VT-Calls”) if they observed a bird they thought was in the radar beam but had not been called by the radar. Table 6-3 illustrates (see also 6.1.1.5) that radar detect more birds than the visual observers, even when there are few birds in the vicinity¹¹.

Of equal importance to the individual statistics is the sheer number of targets. Over 1500 targets were visually confirmed to be birds (i.e., ground-truthed) by the IVAR teams – more than four times the number of confirmations reported by previous published studies (Burger 1997; Harmata et al. 1999) for analog systems. These targets were confirmed during seven field events at four different geographic locations, during two seasons, at three separate times of day, using radars with both 4° dish and 20° array antennas, and often by different visual observers at each location.

¹¹ NAS Whidbey Island did not make any VT-Calls observations during the fall 2008 studies.

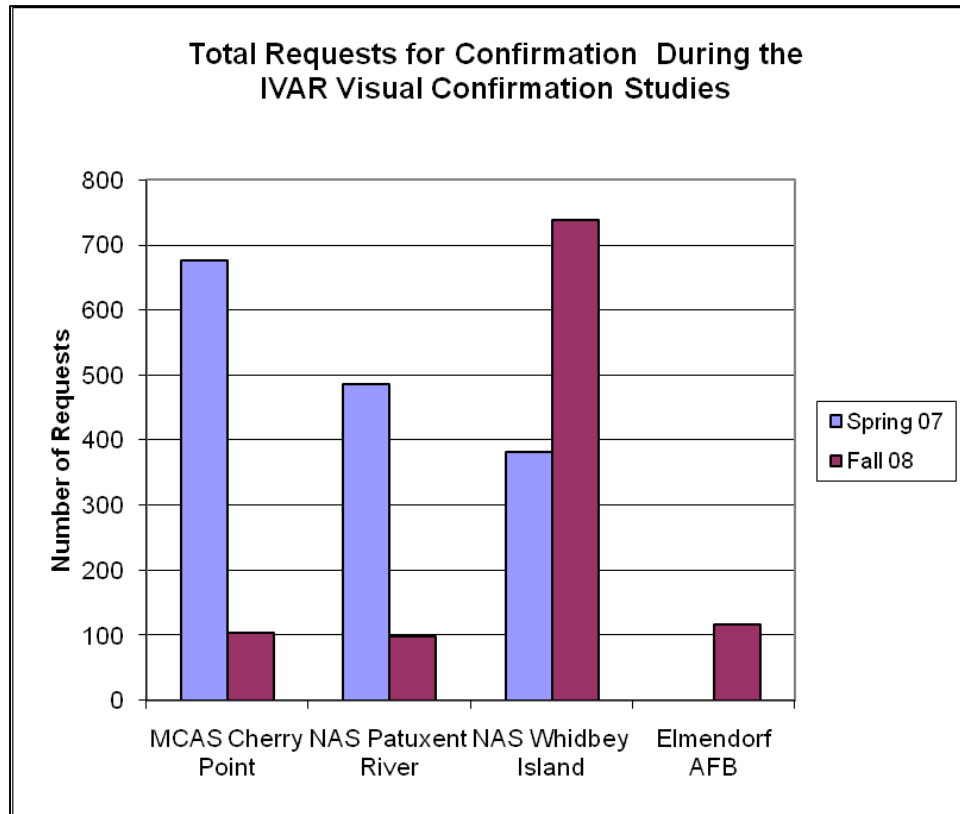

Figure 6-2. Total number of Requests for Confirmation (RFCs) at the four IVAR visual confirmation study locations.

Table 6-3. The number of Requests for Confirmation that were called by the Radar Team (RT-Calls) or the Visual Teams (VT-Calls) during the fall 2008 studies⁵.

	Requests for Confirmation	
	RT-Calls	VT-Calls
MCAS Cherry Point	102	3
NAS Patuxent River	92	7
Elmendorf AFB	96	20

As noted above, the avian radars used for the IVAR studies at MCAS Cherry Point, NAS Patuxent River, and Elmendorf AFB locations were eBirdRad units equipped with dish antennas, while the AR-1 unit with an array antenna was used at NAS Whidbey Island in the Spring 2007. Both the eBirdRad and AR-1 units at NAS Whidbey Island were used for the Fall 2008. The IVAR project did not attempt side-by-side comparisons of the number of confirmed targets tracked by avian radars equipped with dish or array antennas. The limited data from Whidbey Island during the Fall 2008 studies are not comparable because the two units were not operated simultaneously.

Comparing the performance of dish vs. array antennas is complicated due to the complexity of the radar equation. While the large vertical beam width of the array antenna (nominally 20°) may seem attractive for sampling larger volumes of the sky, it illuminates the ground directly and hence must deal with much more clutter – and clutter is the dominant limiting factor in detecting birds with marine radars. Dish antennas on the other hand are usually raised a couple degrees above the ground, and hence have much less ground clutter to deal with. In typical installations, radars using dish or array antennas will actually detect and track similar numbers of birds.

However, like all radar systems, avian radars must be optimized to meet the requirements of the tasks at hand. If those tasks require knowing the altitude of the targets in exchange for a slight decrease in horizontal resolution, then dish antennas can provide height information that array antennas, because of their broad 20° vertical beam width, cannot.

Conclusion

The studies summarized in this section demonstrate successful performance of the metric for PA1.1; namely, that visual observers were able to confirm at three geographic locations that at least 100 targets tracked by the Accipiter® DRP were birds, both single birds and flocks of two or more. During the spring 2007 studies, 915 targets were confirmed to be birds at three locations, while in the fall 2008 studies 616 were confirmed at four locations.

6.1.1.1.2 Validation by Thermal Confirmation

Methods

The detailed descriptions of the methods for using thermal imagery to confirm targets being tracked by an avian radar are presented in Appendix B. We employed those methods and a Thermal Imager-Vertically Pointed Radar (TI-VPR; Gauthreaux and Livingston 2006) system to confirm the identification of targets tracked by an eBirdRad avian radar unit at night and during the day at Edisto Island, South Carolina in the fall of 2008. The procedure cross-validated the radar data gathered with eBirdRad with respect to type of target (i.e., bird, bat, insect), density of targets, altitudinal distribution of targets, and direction of movement.

Figure 6-3 shows the positions of the eBirdRad and the TI-VPR units at the study location. The eBirdRad radar was the same as those used elsewhere in IVAR validation studies: a Furuno FR-2155BB with an Accipiter® DRP. However, the parabolic antenna employed at Edisto Island had a beam width of 2.5°, whereas the other eBirdRad units have a 4° beam parabolic antenna.



Figure 6-3. The locations of eBirdRad and TI-VPR unit use in the thermal validation studies. The eBirdRad (“RT-1”) unit was located in an agricultural field of Sunny Side Plantation, 8360 Peter’s Point Road, Edisto Island, South Carolina, while the TI-VPR unit (“TT-1”) was located 1295 m away in the yard of a residence at 8176 Peter’s Point Road.

Figure 6-4 below shows the basic elements of the TI-VPR. A vertically-pointing Radiance I high-resolution thermal imager was used to identify the heat signatures of biological targets as they pass through the 4° sampling cone above the imager (**Figure 6-5**) and a vertically-pointing X-band radar (also with a 4° sampling cone) that was used as a range finder to measure the altitude AGL of the same targets. A video camera was positioned in front of the radar’s plan position indicator (PPI) display to record the images of targets detected in the radar beam. The analog images from this camera and from the video output of the Radiance I thermal imager were multiplexed, time-stamped, and stored on a DVD for later playback and analysis, as described in Appendix B.



Figure 6-4. The basic sensor elements of the TI-VPR, including a 50 kW X-band Furuno model FR2155-BB radar with a vertically-pointing 4° parabolic dish antenna (left), and Radiance I high-resolution thermal imaging camera (right).

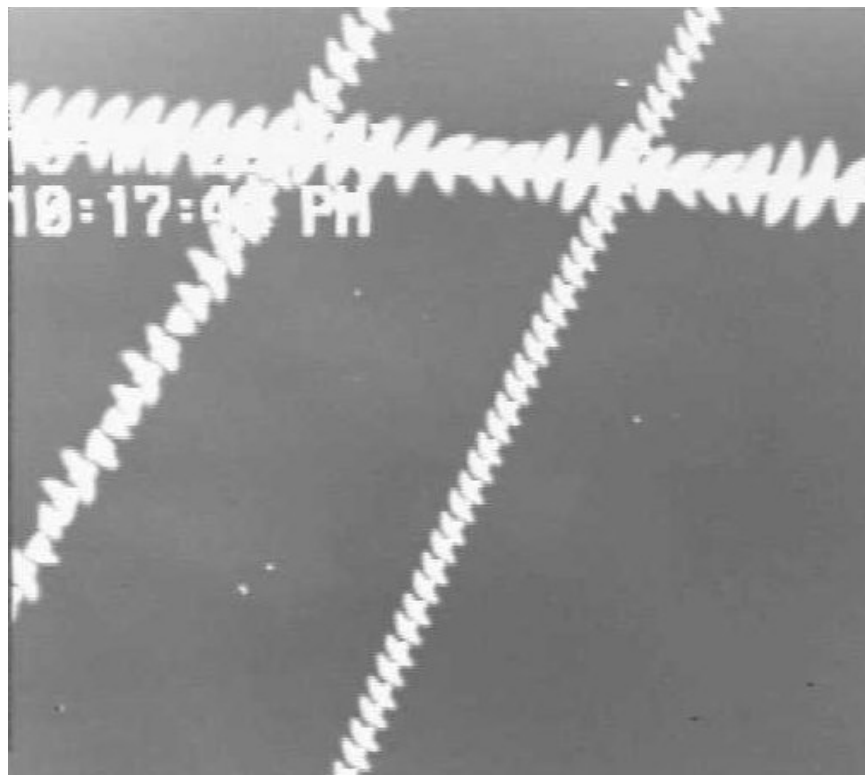

Figure 6-5. Time exposure from the TI-VPR Radiance I thermal imager, showing flight trajectories of birds overhead.

We set the vertically-pointing radar unit to a range¹² of 2.8 km (1.5 nmi) with 0.46 km (0.25 nm) range marks and operated it simultaneously with the thermal imager. The eBirdRad operated continuously, recording tracks 24/7 from 2 October through 5 October 2008. We operated the TI-VPR for eight 1-hour¹³ segments during that same range of dates (**Table 6-4**). We selected the sampling times for the TI-VPR to avoid thick cloud cover, which generates a substantial heat signature that obscures the thermal signatures of targets detected by the thermal imager. Because of the distance (1295 m) between the eBirdRad and the TI-VPR units, we elevated the eBirdRad antenna to 20° and 30° above horizontal to adequately sample migrating birds in the same region with both systems (**Table 6-4**).

Table 6-4. Date, times, and the elevation angle of the eBirdRad antenna during the TI-VPR sampling periods.

Date	Time (UTC*)	Antenna Angle	Comments
2 Oct 2008	22:21-23:22	30°	
3 Oct 2008	01:49-02:52	30°	
3 Oct 2008	15:07-16:11	20°	
3 Oct 2008	16:15-17:17	20°	
3 Oct 2008	19:23-20:26	20°	
4 Oct 2008	01:15-02:17	20° 30°	until 01:30 after 01:30
4 Oct 2008	19:48-20:52	20°	
5 Oct 2008	00:48-01:50	30°	

* The Accipiter® DRP obtains its time values via the Network Time Protocol (NTP; http://en.wikipedia.org/wiki/Network_Time_Protocol). NTP uses Coordinated Universal Time (UTC), the international time standard based on International Atomic Time. UTC only approximates the older, more commonly used GMT (Greenwich Mean Time) with a tolerance of 0.9 second. Time values labeled as “GMT” in this report, notably those in DRP or TVW screen shots, are technically UTC but are reported to only the nearest second.

Following the collection of the field data, we used a TVW to replay the plots and tracks data files recorded by the eBirdRad radar during the eight sampling periods listed in **Table 6-4**. Using the TVW’s alarm tool, we created a 500 m diameter polygon around the location of the TI-VPR and limited the counts of targets by the TVW to just those targets that passed through the polygon. We adjusted the location of the polygon for the antenna elevation angle so that it was located at the same position over the ground even though the slant range differed between antenna elevation angles (see **Figure 6-6** for the 20° antenna elevation, and **Figure 6-7** for 30° the antenna elevation). We set the TVW’s speed filter to <40 m/s to prevent generation of tracks produced by aircraft, but we did not use speed filtering at the low end to remove insect and other targets that were moving about the same speed as the wind. We were able to eliminate insects from the eBirdRad counts because they produced plots (detections) but few tracks (multiple detections for the same target) and their speeds were similar to the wind’s; bats could be eliminated based on their erratic tracks and sharp turns. All other tracks that fell within these parameters were tabulated.

¹² Since the parabolic antenna of the radar used in the TI-VPR is pointed vertically, range in this context is a measure of the target’s altitude.

¹³ An hour is the maximum amount of multiplexed data from the eBirdRad and TI-VPR units that can be stored on a single DVD.

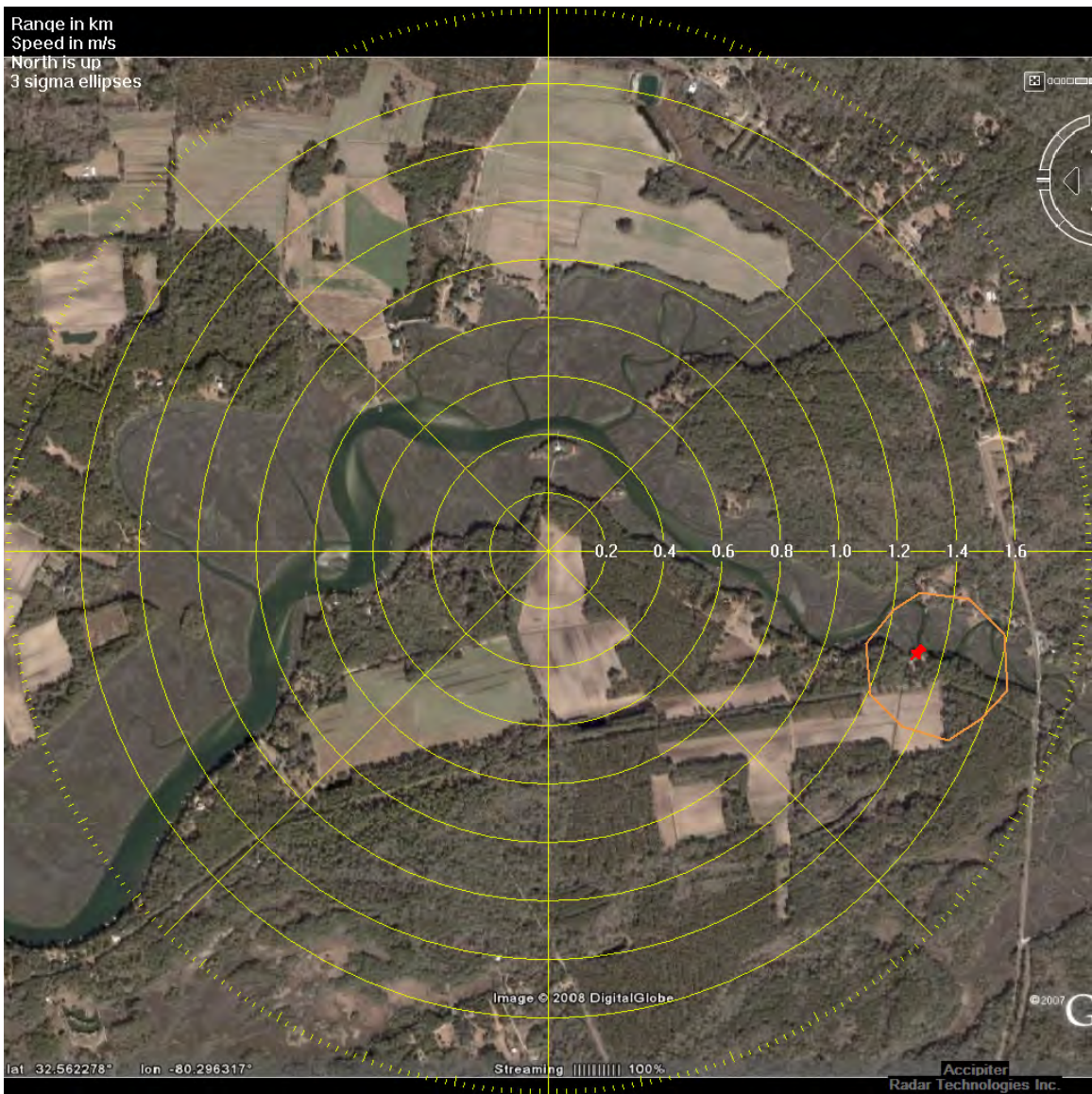

Figure 6-6. The polygon around the position of the TI-VPR (red pushpin) used to delimit the sample area for the eBirdRad data collected with a 20° tilt angle of the antenna.

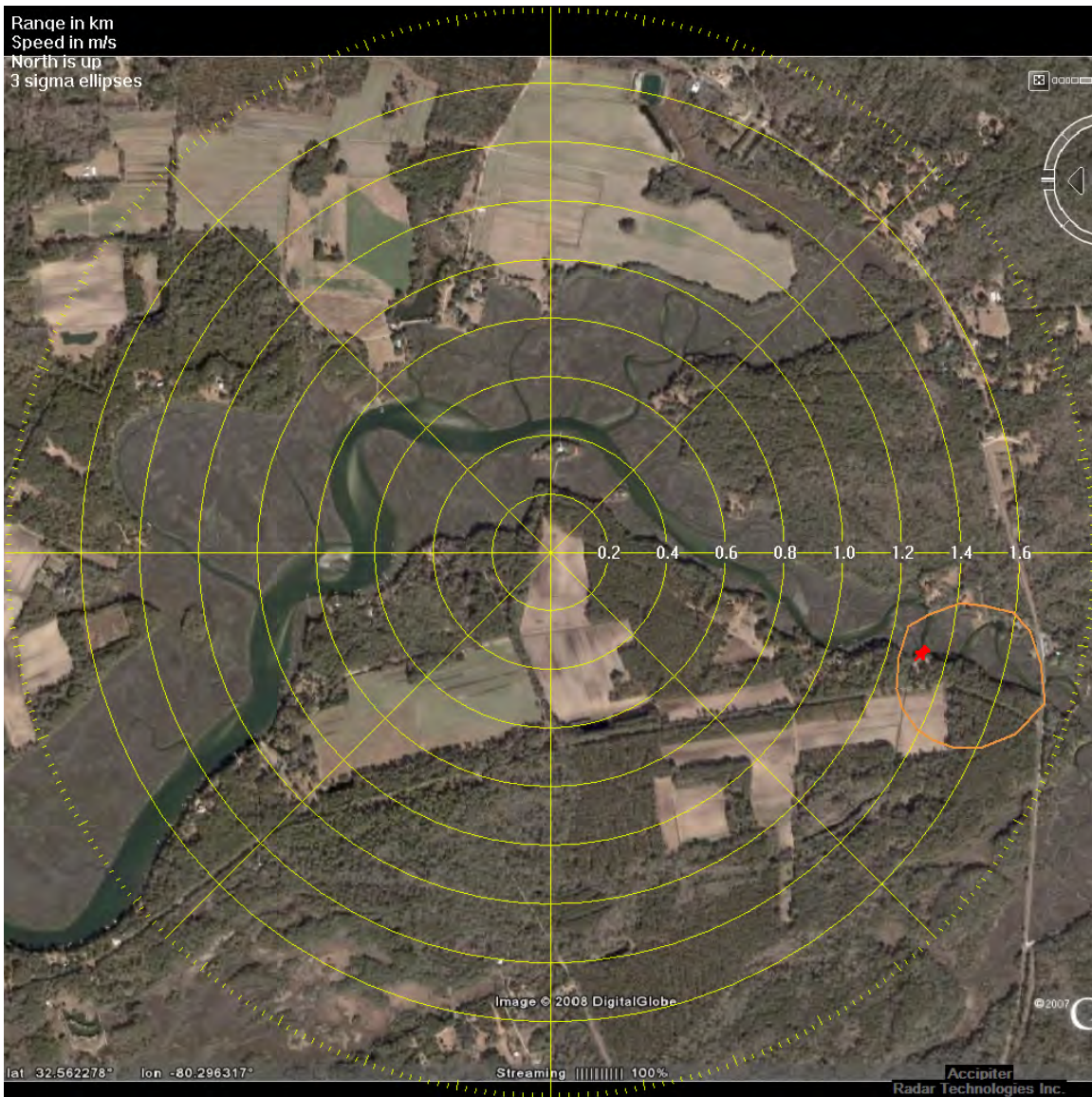
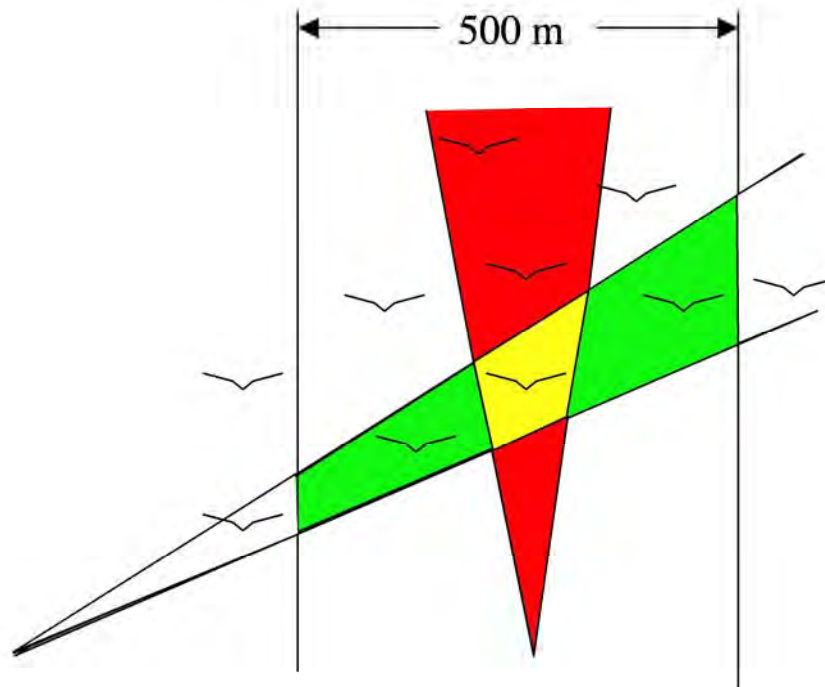

Figure 6-7. The polygon around the position of the TI-VPR (red pushpin) used to delimit the sample area for the eBirdRad data collected with a 30° tilt angle of the antenna.

Figure 6-8 is a diagrammatic representation of the volumes sampled by the eBirdRad and TI-VPR systems during the Edisto Island studies. The grey vertical lines represent the polygon that we used in the TVW to limit the eBirdRad counts to targets that were within a 250 m radius of the TI-VPR; only birds passing through the radar beam within this polygon (green & yellow) were counted for this analysis. The red and yellow segments represent the volume sampled by the TI-VPR, while the yellow section is the volume sampled by both the eBirdRad and TI-VPR units.



eBirdRad

Thermal Imager &
Vertically-pointing Radar

Figure 6-8. Diagram of sampling “volumes” of eBirdRad and the TI-VPR (not to scale). The green and yellow denote the sampling volume of the eBirdRad and the red and yellow the sampling volume of the TI-VPR. The yellow indicates the sampling volume of the thermal imager that is within the coverage of eBirdRad. The vertical gray lines represent the edge of the eBirdRad sample polygon depicted in Figure 6-6 and Figure 6-7.

For the thermal counts, we used a demultiplexer to extract and play back from the DVD the time-synchronized images recorded from the vertically-pointing radar and the thermal imager and to display them side-by-side (**Figure 6-9**). When a biological target entered the thermal imager display, the analyst would halt the playback and record on a data sheet the date and time, identification (bird, bat, insect), number of individuals, direction of movement, altitude above radar level (taken from the simultaneous vertically-pointing radar video display). We entered supplemental data on target behavior (e.g., circling, zigzag flight, hovering) into the comments column of the data sheet.



Figure 6-9. Dual display of video from thermal imager (left) and vertically-pointing radar (right).

We calculated the sampling volumes of the two devices based on their characteristics (**Table 6-5**; see also **Figure 6-8**).

Table 6-5. Altitude of the radar beam over the TI-VPR and the diameter of the TI-VPR’s field of view at those altitudes.

Angle (range) of radar antenna	Altitude of radar beam over TI-VPR	Diameter of TI-VPR field of view at the altitude of radar beam
20° (18.75 – 21.25°)	444 – 500 m	31 – 35 m
30° (28.75 – 31.25°)	721 – 778 m	50 – 54 m

We tabulated the number of birds tracked by both the eBirdRad and the TI-VPR on a minute-by-minute basis, and then grouped the data into 5-minute subsamples. To calculate the hourly rates of movement, we summed the results of all 5-minute subsamples for each hourly session.

Several factors make it difficult to relate a single target in the TI-VPR to the same target track in the eBirdRad data. These factors include:

- The eBirdRad radar has an approximately 2.5-second time delay in updating target position data caused by the fixed scan period of the radars. Thus, in the worst case the two systems (eBirdRad and TI-VPR) could as much as 1.25 seconds out of phase with one another.

- It takes several scans (nominally, three) for the DRP's tracking algorithm to determine whether a pattern of detections for a target warrants elevation to a confirmed track. This can add another ~8 seconds to the time uncertainty between the eBirdRad and TI-VPR tracks for a given target.
- The complications of these factors are compounded when a large numbers of birds are flying and being sampled by both systems. With so many targets in the area, it is difficult to say for certain which targets are the same for both systems.

We decided a more practical approach to confirming targets with thermal imagery was to treat the data from the two methods as samples (of the population of birds migrating overhead) and to correlate the counts of birds passing through the field of view of the TI-VPR with the counts of eBirdRad tracks that passed within a 250 m radius of the TI-VPR (see polygons in **Figure 6-6** and **Figure 6-7**). On this basis, we performed the following comparisons of the eBirdRad and the TI-VPR sampling results:

1. Compared 5-min segments of eBirdRad and TI-VPR data, overall (green and yellow with yellow and red in Figure 6-8).
2. Compared 5-min segments of TI-VPR birds at the same altitude as the radar beam (yellow in Figure 6-8).
3. Compared 1-hour sessions for TI bird counts, overall (green and yellow with yellow and red in **Figure 6-8**).
4. Compared 1-hour segments for TI birds that are at the same altitude as the radar beam yellow in **Figure 6-8**).

Results

The comparisons of bird counts in the TI-VPR and those in the sample polygon of the eBirdRad co-varied significantly. The correlation of overall counts within 5-minute segments from eBirdRad and TI-VPR was highly significant ($r = 0.829$, $v = 94$, $P < 0.001$, **Figure 6-10**). The correlation of counts within 5-minute segments from TI-VPR at the same altitude as the radar beam of eBirdRad was lower but also highly significant ($r = 0.639$, $v = 94$, $P < 0.001$, **Figure 6-11**). The correlation of overall counts from the TI-VPR and eBirdRad for each 1-hour session was highly significant ($r = 0.943$, $v = 6$, $P < 0.001$, adjusted $R^2 = 0.8716$; **Figure 6-12**), and the correlation of counts from the TI-VPR at the same altitude as the radar beam of eBirdRad for each 1-hour session was also highly significant ($r = 0.952$, $v = 6$, $P < 0.001$, adjusted $R^2 = 0.8911$; **Figure 6-13**).

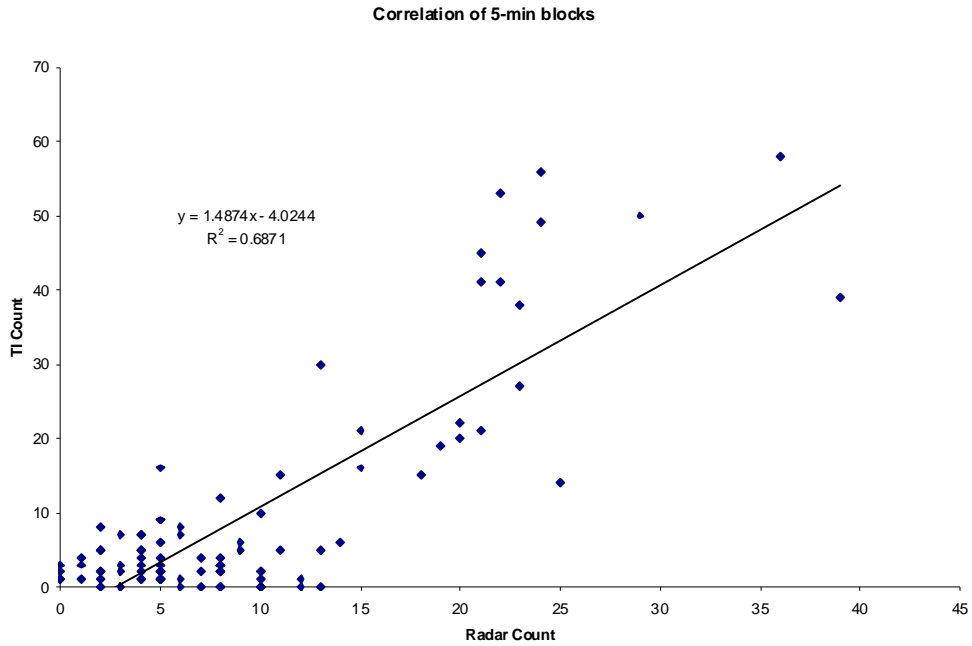

Figure 6-10. Comparison of 5-minute segments for all thermal imager birds: $y = 1.4874x - 4.0244$, $R_a^2 = 0.6838$, $df = 191$; $r = 0.829$, $v = 94$, $P < 0.001$.

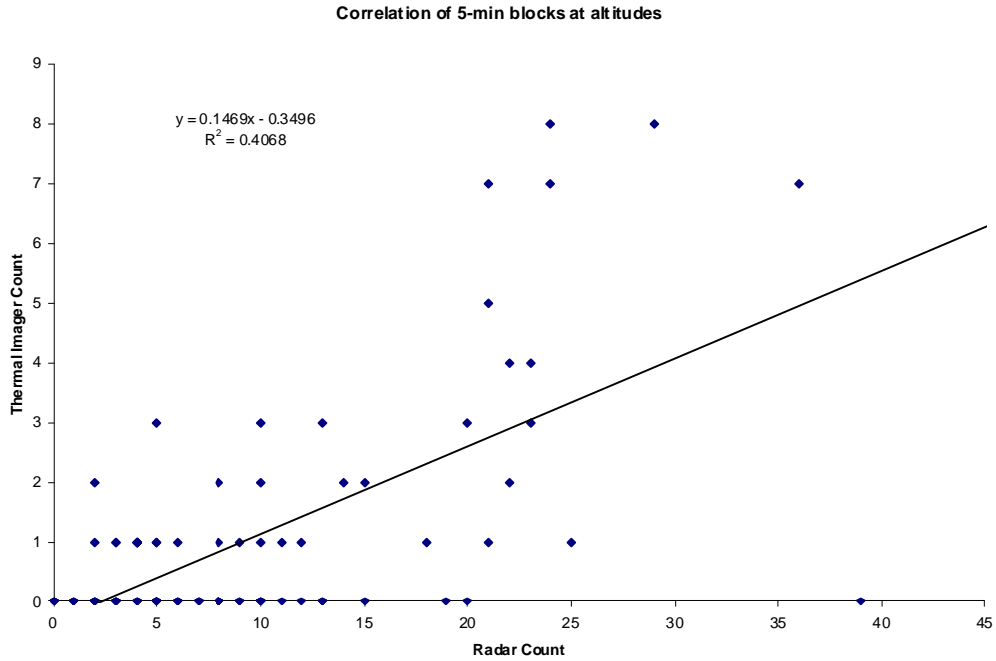

Figure 6-11. Comparison of 5-minute segments for thermal imager birds at the altitude of the eBirdRad radar beam: $y = 0.1469x - 0.3496$, $R_a^2 = 0.4005$, $df = 191$; $r = 0.639$, $v = 94$, $P < 0.001$.

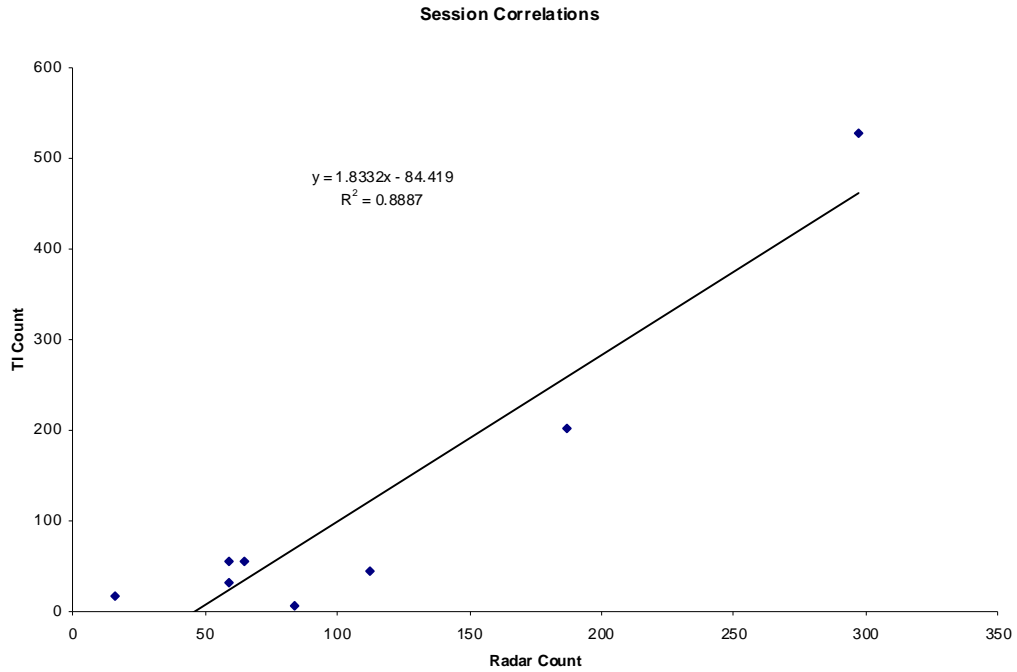

Figure 6-12. Comparison of 1-hour sessions for all thermal imager birds: $y = 1.8332x - 84.419$, $R_a2 = 0.8716$, $df = 15$; $r = 0.943$, $v = 6$, $P < 0.001$.

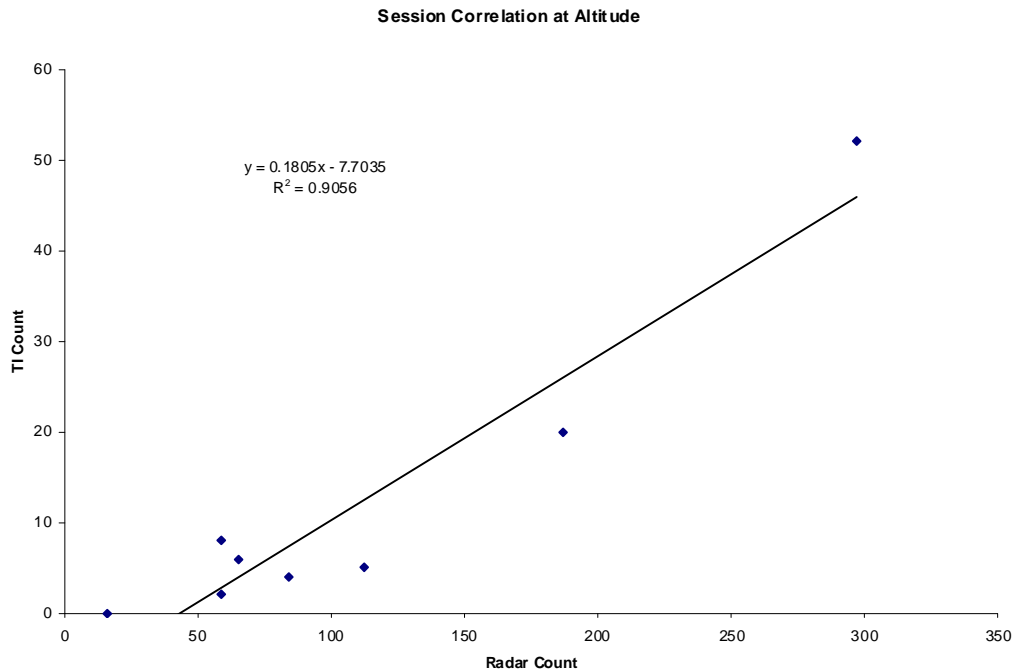

Figure 6-13. Comparison of 1-hour sessions for thermal imager birds at the altitude of the eBirdRad radar beam: $y = 0.1805x - 7.7035$, $R_a2 = 0.8911$, $df = 15$; $r = 0.952$, $v = 6$, $P < 0.001$.

All four correlations were significant at the $P < 0.001$ level. The poorest was between the counts of birds for 5-minute segments from the TI-VPR at the same altitude as the radar beam of eBirdRad. This correlation is probably lowest (but still significant) because the TI-VPR dataset contained many 0 and 1 values when restricted to this altitudinal range (**Figure 6-11**). Several of the 5-minute samples contained no birds when bird movements were of lower density. On the other hand, the highest correlation ($r = 0.952$) was for the comparison of the hourly samples between the radar data and the TI data at the altitude of the radar beam.

These results should be viewed as a comparison of two sampling techniques, not a bird-to-bird comparison of the data. To compare the techniques, we should use all the data collected by each device rather than restrict one or the other to a specific subset of data (e.g., the thermal imager to the altitudes of the radar beam).

The sampling volume of the thermal imager ($2.734 \times 10^7 \text{ m}^3$) is about 2.5 times that of the eBirdRad sampling volume ($1.10 - 1.12 \times 10^7 \text{ m}^3$), depending on antenna angle. However, the lower part of the thermal imager sampling volume would be expected to record few birds during migration because birds typically fly at least 150 m above the ground. Thus, the thermal imager would be expected to detect more birds than the radar but not 2.5 times as many. In fact, the regressions (**Figure 6-10** and **Figure 6-11**) show that the thermal imager detected about 1.5 – 2 times as many birds as did the eBirdRad.

While it was our original intent to use the TI-VPR to confirm 100+ birds that were tracked by eBirdRad, bird-to-bird comparisons proved unfeasible because of the complications listed above. Overall we recorded more than 900 birds using each method and more than 100 birds on several nights, but we could not make a bird-to-bird comparison as was done in the visual studies. Although we cannot identify specific targets, we can confidently state that the eBirdRad and TI-VPR simultaneously detected more 100 birds during the study. These would be the birds that passed through the yellow area of **Figure 6-8**.

Conclusion

The two sampling techniques produced similar values for the numbers of birds aloft, one through active detection (radar) and one through passive detection (thermal imager). Although a bird-to-bird comparison could not be made, the numbers of birds per volume are similar and within the range of expected values when the sampling volumes of the two techniques are considered. On this basis, we conclude that thermal imagery, like visual observations, successfully demonstrates that avian radar can track single birds and flocks in accordance with Performance Criterion PA1.1.

6.1.1.1.3 Validation Using a Remotely Controlled Vehicle

Methods

Unmanned aerial vehicles (UAV) can provide targets of known characteristics at known positions, which can be used to assess the capabilities of avian radars to automatically track targets that mimic birds. Remote controlled helicopters (RCH) are small targets that can be flown to mimic bird flight. We chose to use an RCH to demonstrate that the automatic tracking coordinates produced by the DRP software used in the eBirdRad, AR-1, and AR-2 radars are accurate. These remotely controlled targets also allowed us to assess the sensor's resolution limits. By placing a GPS on board the RCH, we were able to record the coordinates of the RCH during flight tests and subsequently compare them to tracks of the RCH produced by the radar.

To evaluate the capabilities of the avian radar system to track a UAV, we conducted a trial at SEA on 14 September 2008 using the SEAAR1m radar there. A new third runway (34L/16R) was constructed at SEA as part of a multiple-year runway expansion program; the runway was not yet in use at the time of our test. After the Federal Aviation Administration granted the Port of Seattle permission to fly a RCH near Runway 34L/16R we selected several sites along it to use in the trials. The method of testing is described as follows:

1. Fly the RCH within the coverage zone of the radar and at detectable ranges while recording the helicopter's trajectory with an onboard GPS device.
2. Operate the radar to track the RCH, recording both raw digital data and plots and tracks data for subsequent reprocessing and analysis.
3. Extract helicopter position from the onboard GPS device in suitable format
4. Extract helicopter radar track coordinates by reprocessing radar digital data
5. Compare radar track coordinates of the helicopter and GPS coordinates by overlaying them onto a common graph or display
6. Determine the radar's tracking accuracy by determining the deviation between the two sets of data, taking into consideration the uncertainty of the GPS coordinates.

We designed the radar trials to provide repetitive flight patterns along the length of the new runway, which would allow acquisition, loss, and reacquisition of the RCH target along the full length of the 2500 m runway. We controlled the RCH from a moving vehicle that traveled the perimeter road at SEA, approximately 2 m lower than the runway elevation. The pilot flew the RCH from near the surface of the perimeter road to an altitude of approximately 150 m above the road, and then returned to near the road surface. This flight path produced a target arc where altitude increased and decreased along the runway. When the target flew near the surface of the perimeter road, it was below the level of the runway and thus shadowed from the radar beam. We implemented this flight path to test detection capabilities at different distances from the fixed radar location, assess detection differences with altitude, assess capabilities for acquisition of the target when it rises above the radar horizon, and characterize track generation with target loss.

For this test we used an Appareo Systems GAU 1000 GPS unit with a data logging and recording system. The GAU 1000 provides GPS coordinates at 1 second intervals, with an accuracy of ± 10 m. We mounted the GPS unit on the RCH and retrieve the data records following the flight.

We operated the SEAAR1m radar in the normal surveillance mode used for bird detection and tracking. The DRP was set to record both digitized raw data and extracted plots and tracks data. We used an Accipiter® DRP to reprocess the raw digital data file into plots and tracks and then to isolate the helicopter data from all other plots and tracks based on location, timing, and velocity criteria. We used the extracted plots and tracks data in the field to verify radar functionality.

Results

We successfully flew the RCH, shown in Figure 6-14, for the entire length of the new runway from the pilot vehicle along the adjacent perimeter road. We achieved our planned flight path so that it had multiple arcs from near the surface of the perimeter road to approximately 150 m above ground level (AGL) along the runway.



Figure 6-14. Remote-controlled helicopter (RCH) on the SEA perimeter road with pilot and observer.

We initiated the RCH flight at the south end of Runway 34L/16R, moved north along the full length of the runway, as indicated in Figure 6-16, and we achieved radar and GPS tracking the full length of the runway. We identified and isolated RCH tracks from other targets based on their track location, time of detection, and velocity profiles of possible targets.

Although the RCH was flown in a three dimensional flight path, the AR-1 radar was equipped with an array antenna that only provided range and azimuth data, no altitude data. The tracks of the RCH as it flew along Runway 3 are illustrated in Figure 6-15 and **Figure 6-16**. The four separate tracks illustrated in different colors in **Figure 6-16** are the result of the tracking algorithm characteristics. When the RCH flew near to the surface of the perimeter road and was shielded from the radar beam for several scan periods (~8-10 s), that track ended and the radar software assigned a new track number upon the reacquisition of the RCH when it rose above the level of the runway and was again within the radar beam.



Figure 6-15. Runway 3 at SEA, showing where the remote helicopter tests were conducted.

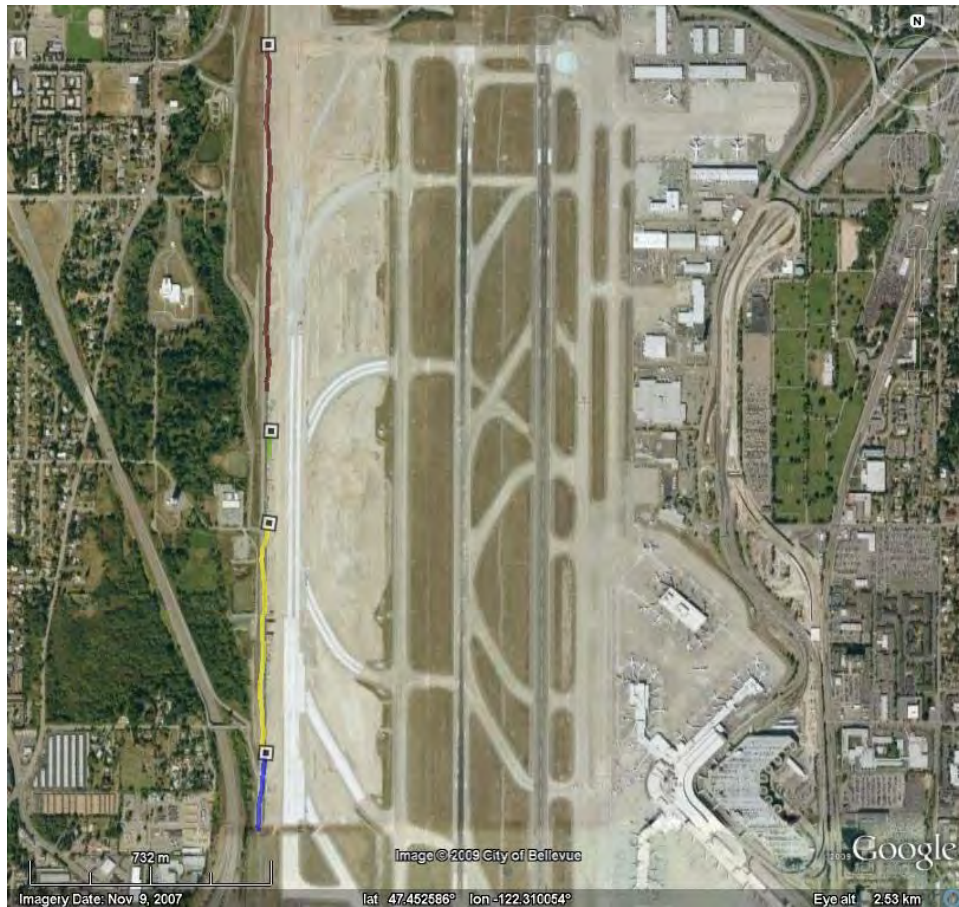

Figure 6-16. Tracks of the RCH acquired by the SEAAR1 radar providing flight path information as the target flew along Runway 34L/16R at SEA. The colored lines are the tracks of the RCH, which end as the RCH dipped below the level of the runway and was lost by the radar. The small blocks at the ends of each line denote the position of the RCH when it was lost by the radar. These four lines represent Track IDs 449, 571, 632, and 860.

Next we used the DRP to extract from the raw digital data the northing and easting coordinates for each track update of the RCH position¹⁴. Because tracks were terminated with passage of the RCH below the radar horizon, the complete track for the RCH is composed of four separate Track IDs: 449, 571, 632, and 860. We used only Track IDs 860 and 632 in our analyses because they provided multiple cycles of a rising and falling RCH while tracks 449 and 571 contained either single or partial cycles.

We plotted the northing coordinates derived from radar Track IDs 860 and 632 and from the GPS device onboard the RCH versus time in Figure 6-17 and Figure 6-18, respectively. Likewise, we plotted the easting coordinates from the radar and the GPS device in Figure 6-19 and **Figure 6-20**; in both figures we plotted helicopter elevation related to runway position. The accurate tracking of northing coordinates from the onboard GPS and the radar are evident in **Figure 6-17** and **Figure 6-18**; the plotted easting coordinates were not as accurate. In making

¹⁴ To simplify the computations and comparison to the GPS-based data, we used UTM northing and easting coordinates instead of latitude and longitude. All UTM coordinates are from Zone 10N.

comparisons between the RCH-GPS data and the radar data below, keep in mind that the RCH-GPS data are updated every 1.0 second and the radar data every 2.5 seconds. As a result the RCH-GPS tracks show a finer-scale display of location.

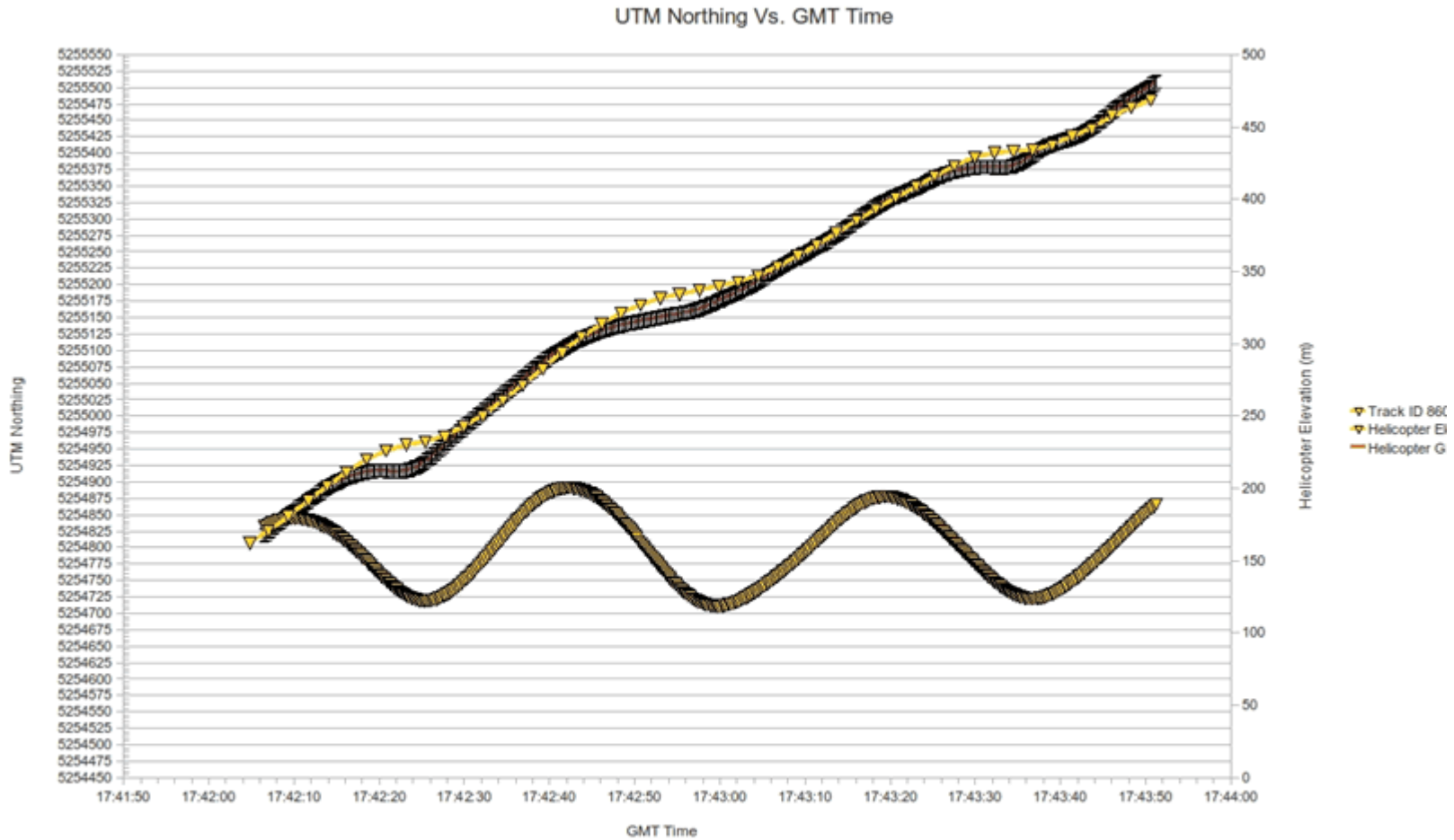

Figure 6-17. Plot of the northing coordinates and elevations of the RCH versus time at SEA on 14 September 2008. Of the two diagonal lines, the red line with error bars (“Helicopter GPS”) represents the northing coordinates of the target based on the GPS on the RCH; the yellow line with triangles (“Track ID 860”) represents the northing coordinates from the SEAR1m radar. The lower, sinusoidal line with the yellow triangles represents the elevation of the track from the GPS on the RCH.

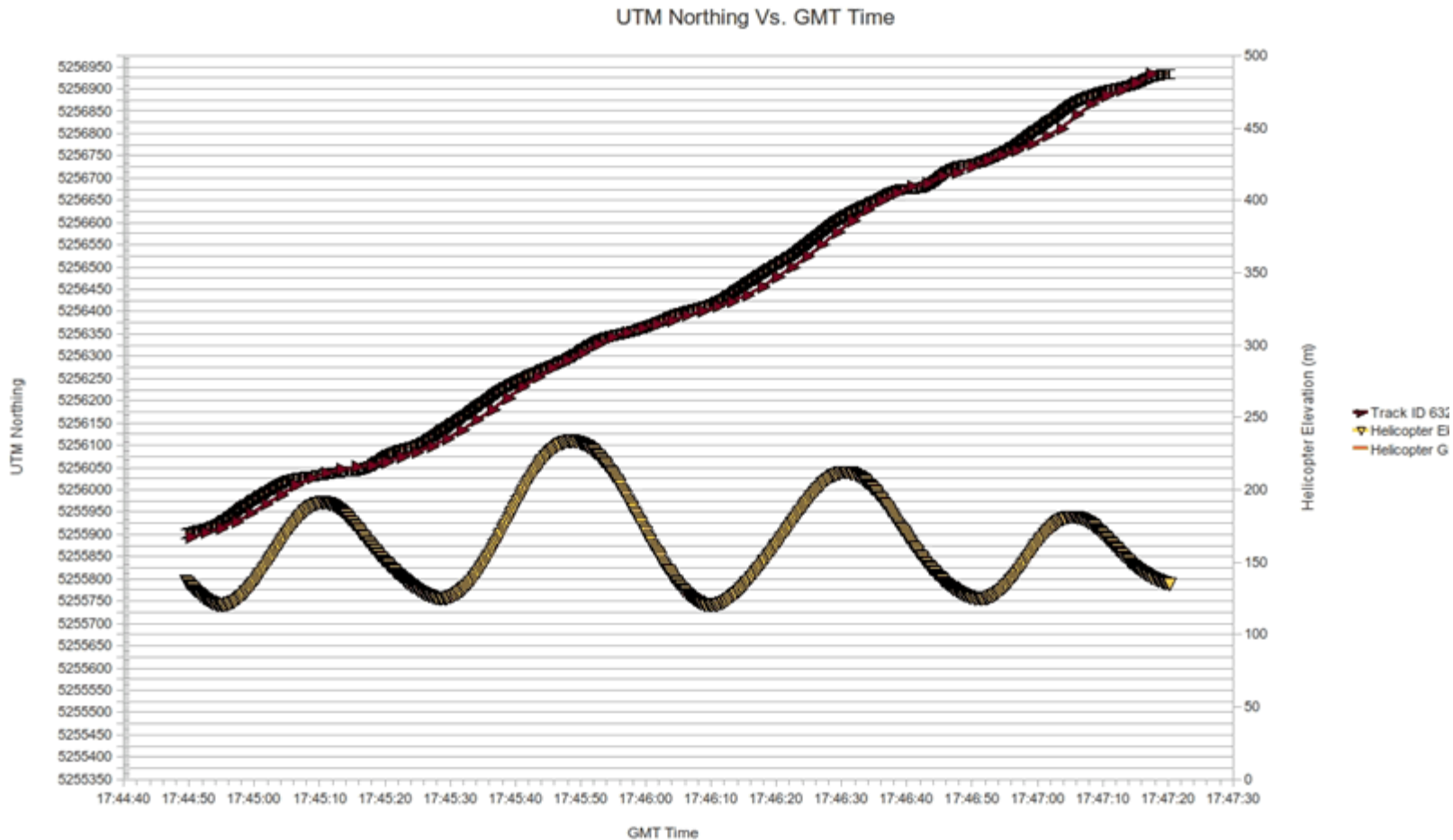

Figure 6-18. Plot of the northing coordinates and elevations of the RCH versus time at SEA on 14 September 2008. Of the two diagonal lines, the red line with error bars (“Helicopter GPS”) represents the northing coordinates of the target based on the GPS on the RCH; the red line with triangles (“Track ID 632”) represents the northing coordinates from the SEAAR1m radar. The lower, sinusoidal line with the yellow triangles represents the elevation of the track from the GPS on the RCH.

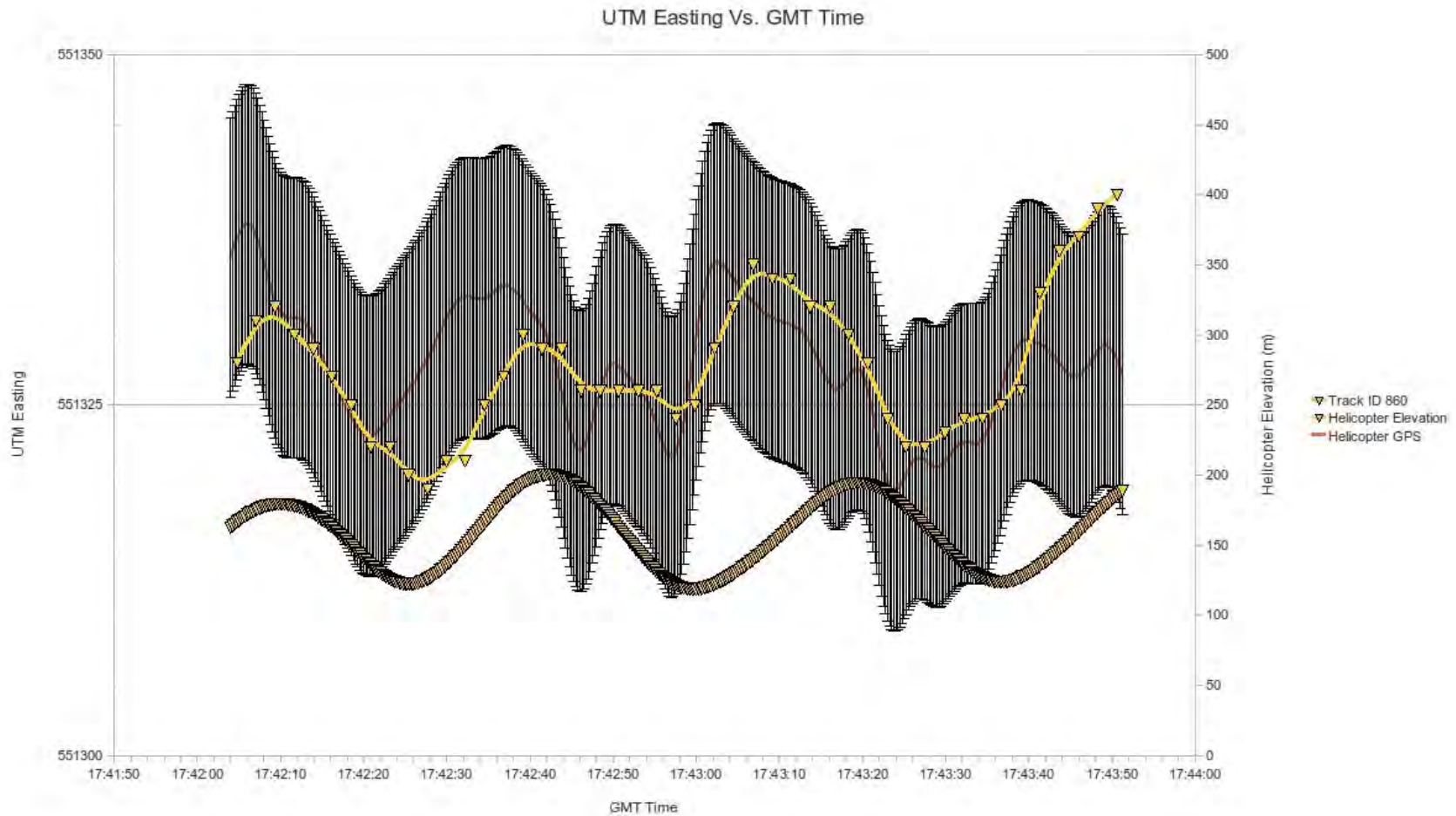

Figure 6-19. Plot of the easting coordinates and elevations of the RCH versus time at SEA on 14 September 2008. Of the two upper lines, the red line with error bars (“Helicopter GPS”) represents the easting coordinates of the target based on the GPS mounted on the RCH; the yellow line with triangles (“Track ID 860”) represents the easting coordinates from the SEAAR1m radar. The lower, sinusoidal line with the yellow triangles represents the elevation of the RCH based on GPS records.

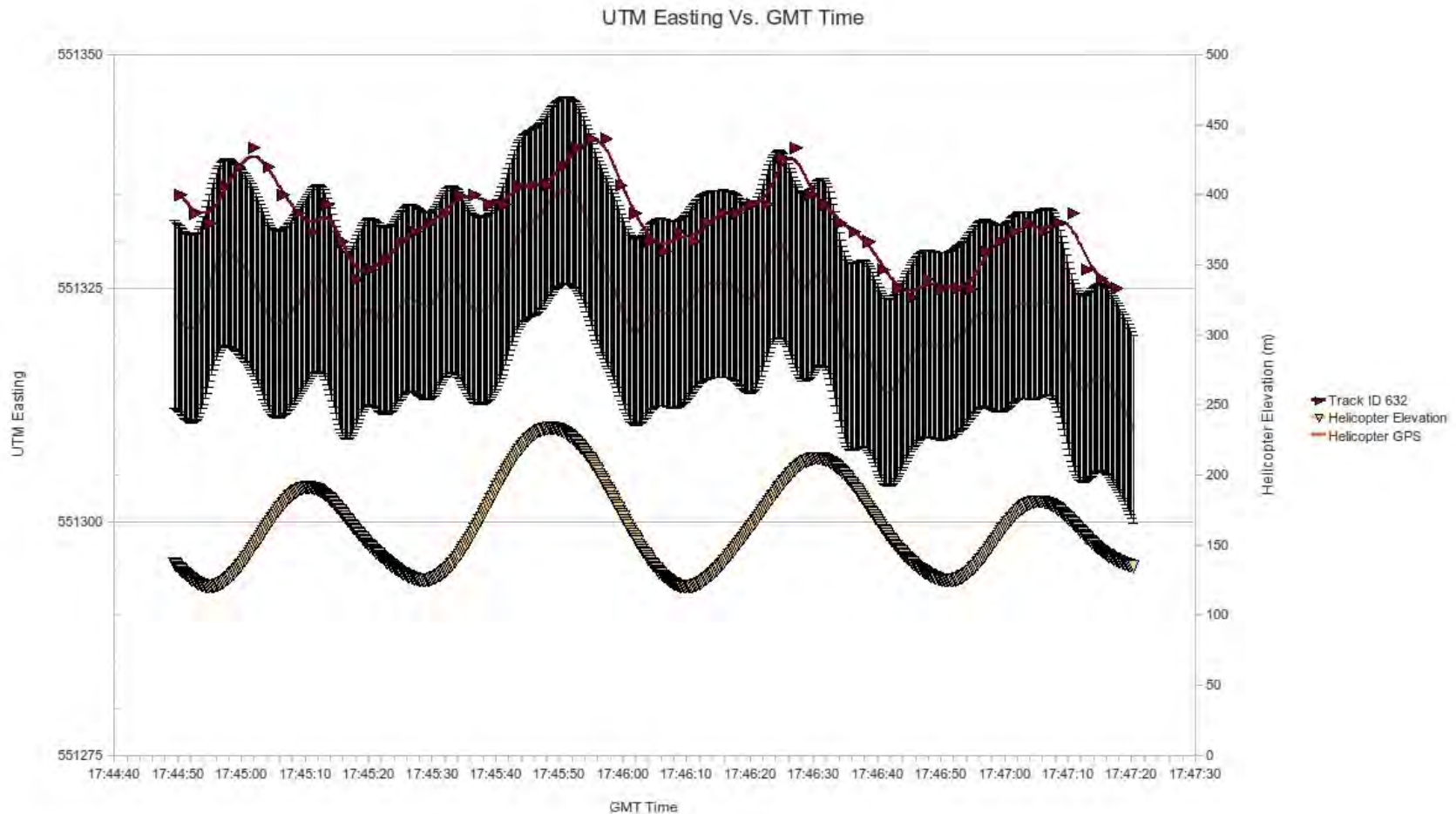

Figure 6-20. Plot of the easting coordinates and elevations of the RCH versus time at SEA on 14 September 2008. Of the two upper lines, the red line with error bars (“Helicopter GPS”) represents the easting coordinates of the target based on the GPS on the RCH; the yellow line with triangles (“Track ID 632”) represents the easting coordinates from the SEAAR1m radar. The lower, sinusoidal line with the yellow triangles represents the elevation of the track from the GPS on the RCH.

From the data presented in **Figure 6-17** through **Figure 6-20**, we determined the relationships between GPS and radar coordinates of the RCH. Although the clock in the radar computer was not precisely synchronized with the GPS clock, the two time bases were very. The expected location error in the GPS measurements, the influence of not knowing the altitude to incorporate into the radar range determination, the location uncertainty caused by the radar beam width, and expected error in radar range uncertainty resulting from the duration of the pulse determination at this scale made statistical correlational analysis infeasible. Instead, we calculated the percentage of radar coordinates that were within the GPS error for the Northing and Easting coordinates in each track (**Table 6-6**).

Table 6-6. Difference between the northing and easting coordinates supplied by the GPS onboard the RCH and those supplied by the radar tracking the RCH.

	Track ID 632		Track ID 860		Overall	
	Northing	Easting	Northing	Easting	Northing	Easting
Average Difference (m)	28.32	9.19	12.09	8.37	21.57	8.85
Maximum Difference (m)	58.22	18.76	39.84	19.96	58.22	19.96
Minimum Difference (m)	0.55	0.60	0.01	0.70	0.01	0.54
Within-GPS Error (%)	13.64	60.61	59.57	68.09	59.57	68.09

The results indicated that the radar effectively acquired the RCH target as it rose above the runway level and tracked the RCH through several cycles of a rising and falling elevation. This result confirms the capability of the radar to detect and track the position of a known RCH target at different elevations and at different ranges from the radar. The results also confirmed that the track of the same target may be broken into several shorter tracks depending on the time the target is out of the radar beam.

We observed that the reported position of the RCH reported by the radar was within the expected GPS error approximately 60% of the time. Assessment of Figure 6-17 and Figure 6-18 suggests that the greatest difference between the radar RCH position and the GPS coordinates was at low RCH elevations, when the tracking algorithm may have substituted predicted position for actual position as the target dipped below the radar beam.

The differences between northing and easting accuracy may be related to slant-range effects where range differs with elevation; they may also be related to processing time differences that made exact correlation between radar RCH position and the GPS position infeasible.

The objective of this test was to control the RCH flight path to mimic birds in flight and assess the detection capability of the radar along Runway 34L/16R. From other observations we made at SEA, birds are known to regularly fly along the western margin of the airport at different altitudes. The runways at SEA are approximately 75 m above the surrounding terrain, so periodic flight above the runway horizon is typical of bird flight in this area. The radar effectively detected and tracked the RCH target, which mimics the actual flight paths of birds in the area.

Conclusion

In the quantitative performance objectives for PA1.1, Automatic Tracking, one performance criterion was to use a UAV to independently confirm the target's spatial coordinates as determined by the radar. The comparison of the GPS position data from the RCH with the radar tracks generated by the DRP successfully confirmed the capability of the radar to detect and automatically track the spatial coordinates of the UAV to within 10 m even when the ranges are uncorrected for slant-range geometry.

6.1.1.1.4 Summary Conclusions for PA1.1

We used three separate methods to successfully demonstrate the objective of PA1.1: that the avian radar systems evaluated by the IVAR project can automatically detect and track single birds and flocks. We first demonstrated this capability by visually confirming over 900 targets tracked by the radars at three geographic locations in the spring of 2007 to be birds, and then that more than 600 targets were birds at four locations in the fall 2008. Next, we demonstrated the number of birds detected in a given sampling volume by a radar (active detection) were comparable to those detected by a thermal imager (passive detection), in particular at night when visual sampling methods are inadequate. Finally, we used an RCH outfitted with a recording GPS to confirm that the spatial coordinates generated by the avian radar's DRP when tracking these targets are accurate.

6.1.1.2 Provides Location Information Versus Time for Each Track [PA2.1]

Objective

Performance Criterion PA1.1, Provides Location Information Versus Time for Each Track, is a primary quantitative criterion for demonstrating automatic tracking of birds using avian radar. Whereas Criterion PA1.1 (Section 6.1.1.1) was designed to demonstrate that target echoes generated by a radar scan could be detected and tracked in real time by the DRP, Criterion PA2.1 will demonstrate that the DRP can also extract and record essential measurement data about those tracked targets; in particular, their spatial and temporal coordinates. The ability to gather these measurement data in real time is the underlying motivation for the development of digital avian radar systems and the data form the basis for most applications of avian radar technology.

Methods

The DRP continuously generates and records "plots and tracks" data as part of its normal operations. Plots are detections above a background level the DRP has extracted from raw digitized radar returns during a given scan of the radar. The DRP's tracking algorithms form tracks by associating plots from scan-to-scan as belonging to the same target.

Plots and/or tracks data are displayed on the DRP monitor and can be stored as files on a local hard drive, on a network file server, or streamed to a Radar Data Server (RDS) and loaded in real time as records in a relational database – or all three simultaneously. A DRP or an Accipiter TrackViewer Workstation (TVW) can (re)play plots and/or tracks data from any of the above sources and display them on the workstation monitor. The Accipiter® Track Data Viewer (TDV) provides the user with a static display of tracks data in a flat-file tabular format similar to a spreadsheet.

The TDV has two track display formats: Master Record, which has one record for each target track, and Detail Record, which has one record for each update (detection) of an individual

target's position, heading, speed, etc. over the history of that track. **Table 6-7** and

Table 6-8 list the field names and descriptions of the Master and Detail display formats, respectively.

Table 6-7. Column headings of the Track Data Viewer Master Record format.

Field (Column) Name	Description
Date	The date the target was first detected and the track started. MM/DD/YY UTC
Track ID	A unique numeric identifier of the track
Start Time	The time the target was first detected and the track started. HH:MM:SS.ss, with 00:00:00.00 = Midnight UTC
Duration	The time, in seconds, the target was tracked.
Number of Updates	The number of scans of the radar in which the target was tracked. This number corresponds to the number of records in the Detailed view for a specific track (Table 6-8)
Start Range (m)	The horizontal distance, in meters, from the radar to the target when the target was first detected.
Start Azimuth (deg.)	The horizontal angle, measured clockwise from True North, between the radar and the target when it was first detected.
Intensity	A measure of the strength of the signal from the target when it was first detected.
Start Heading (deg.)	The horizontal direction, in degrees relative to True North, in which the target was moving when first detected.
Start Speed (m/s)	The horizontal speed, in meters/second, at which the target was moving when first detected.
Start Height (m)	The vertical height, in meters, of the target above the radar antenna when the target was first detected.
Start Latitude	The horizontal position, in decimal degrees relative to the Earth's equator, of the target when it was first detected. Latitudes south of the equator are displayed as negative numbers.
Start Longitude	The horizontal position, in decimal degrees of the target relative to the Prime Meridian, when it was first detected. Longitudes west of the Prime Meridian are displayed as negative numbers.

Table 6-8. Column headings of the Track Data Viewer Detailed Record format.

Field (Column) Name	Description
Date	The date the target data were updated. MM/DD/YY UTC
Track ID	A unique numeric identifier of the track
Update Time	The time the target data were updated. HH:MM:SS.ss, with 00:00:00.00 = Midnight UTC
Intensity	A measure of the strength of the signal from the target when the target data were updated.
Range (m)	The horizontal distance, in meters, from the radar to the target when the target data were updated.
Azimuth (deg.)	The horizontal angle, measured clockwise from True North, between the radar and the target when the target data were updated.
Height (m)	The vertical height, in meters, of the target above the radar antenna when the target data were updated.
Heading (deg.)	The horizontal direction, in degrees relative to True North, in which the target was moving when the target data were updated.
Speed (m/s)	The horizontal speed, in meters/second, at which the target was moving when the target data were updated.
Latitude	The horizontal position, in decimal degrees relative to the Earth's equator, of the target when the target data were updated. Latitudes south of the equator are displayed as negative numbers.
Longitude	The horizontal position, in decimal degrees relative to the Prime Meridian, of the target when the target data were updated. Longitudes south of the equator are displayed as negative numbers.
UTM Zone	The Universal Transverse Mercator zone in which the target was present when the target data were updated.
UTM Northing	The north-south (y-axis) coordinates of the target's position within the UTM Zone when the target data were updated.
UTM Easting	The east-west (x-axis) coordinates of the target's position within the UTM Zone when the target data were updated.

Results

The Accipiter® DRP file format is identical for all tracks data; thus, the spatial and temporal data from any target could have been used as a demonstration of Performance Criterion PA2.1. We chose for this demonstration a short but representative track. Track ID 111 was recorded during Session 3 on 24 September 2008 at NAS Patuxent River, Maryland, starting at 11:04:51.41 UTC (07:04:51.41 EDT) and continuing for 8 updates (~20 seconds duration). The target was confirmed visually to be a Double-crested Cormorant by Visual Team #2, the team to whom the RFC was broadcast. Table 6-9 presents the spatial and temporal coordinate data for the eight updates of Track 111.

Table 6-9. Geospatial coordinates vs. time of Track ID 111, NAS Patuxent River, Maryland, 24 Sep 2008.

Date	Update Time (GMT)	Latitude	Longitude	Height (m)
9/24/2008	11:04:51.41	38.2782	-76.3912	153.3
9/24/2008	11:04:54.16	38.2777	-76.3915	153.5
9/24/2008	11:04:56.90	38.2772	-76.3917	153.9
9/24/2008	11:04:59.65	38.2767	-76.3920	154.8
9/24/2008	11:05:02.40	38.2762	-76.3921	156.8
9/24/2008	11:05:05.14	38.2755	-76.3923	159.4
9/24/2008	11:05:07.86	38.2750	-76.3926	161.4
9/24/2008	11:05:10.65	38.2744	-76.3928	163.8

Figure 6-21 is a Google Earth plot of the track position data from Table 6-9. The RFC broadcast by the Radar Team to VT2 reported the target was approximately 400 m east of their position, moving south. These spatial relationships between the observers and the target are apparent in the oblique view of the target in this figure, as is the nearly level flight path of the target.



Figure 6-21. Trajectory of Track ID 111 at NAS Patuxent River, Maryland relative to site VT-2 that visually confirmed the target on 24 September 2008. The blue, red, and green placemarks denote the start, confirmed, and end positions of the target track, respectively.

Table 6-9 demonstrates quantitatively that the Accipiter® DRP measures and records the spatial coordinates approximately every 2.5 seconds (the scan period of the radar) throughout the duration of a track. Figure 6-21 depicts how those data can be used to visualize the spatial position of a target through time.

Conclusion

The results of the study presented in this section successfully demonstrate the eBirdRad avian radar system meets the performance metric for PA2.1 in that it records the 3D spatial coordinates of a target throughout the period during which the target was tracked.

6.1.1.3 Track Capacity [PA3.1]

Objective

We designed PA3.1, Track Capacity, as a primary Performance Criterion that would demonstrate the capability of the avian radar systems evaluated by the IVAR project can track large numbers of birds simultaneously in real time. This capacity is an important prerequisite for many applications of avian radars, in particular studying bird migration, where hundreds of birds may be in the radar's coverage at the same time.

We established as our Success Criterion for PA3.1 that the eBirdRad must be capable of tracking 100 or more birds simultaneously in real time.

Methods

We selected Edisto Island (see Section 4.6) as the study location for demonstrating PA3.1 because of its generally high abundance of birds, particularly during spring and fall migration. The plots and tracks dataset we used for this analysis was recorded by the eBirdRad DRP at Edisto Island as part of the thermal validation studies there in the fall of 2008 (see Section 6.1.1.1.2 for a complete description of the methods and results of the thermal validation studies at Edisto Island). We replayed these plots and tracks data through a TVW and captured the data from a single scan (i.e., antenna revolution) recorded between 01:18:20 and 01:18:22 UTC (21:18:20 to 21:18:22 EST) on 4 October 2008. Then we used the TDV software to capture the track histories for all targets being tracked during the prescribed 2.5-second scan period.

The DRP records Update Time values to the nearest millisecond, but the TDV software only displays these values to the nearest second. This loss in precision required us to include track records with one of three Update Time values - 01:18:20, 01:18:21, or 01:18:22 - to encompass the 2.5-second scan period of the radar in our analysis. A consequence of this was to make it appear that some targets had been sampled twice during the scan period. A target sampled at 01:18:20.00 and again 2.5 seconds later at 01:18:22.50 would, upon rounding to the nearest second, appear to have been sampled at 01:18:20 and 01:18:22 in the same scan. When this occurred, we deleted the older record (i.e., 01:18:20) and used only the single, most recent record for that target in our analysis.

Results

Figure 6-22 is a screen capture of the TVW display at the end of the specified 2.5-second scan period. The white numeric label at the head of some tracks is the unique Track ID of that track; tracks with no Track ID label are no longer being tracked by the radar at the time we generated the screen capture. We included only "active" targets, those with a Track ID label, when

counting the number of targets being tracked simultaneously by the radar. With this stipulation, there are 234 active targets depicted in Figure 6-22.

We included the parametric data for all 234 of these tracks in of Appendix D. For the convenience of the reader, we have included in **Table 6-10** the detailed data for the first ten and the last ten of those 234 targets.

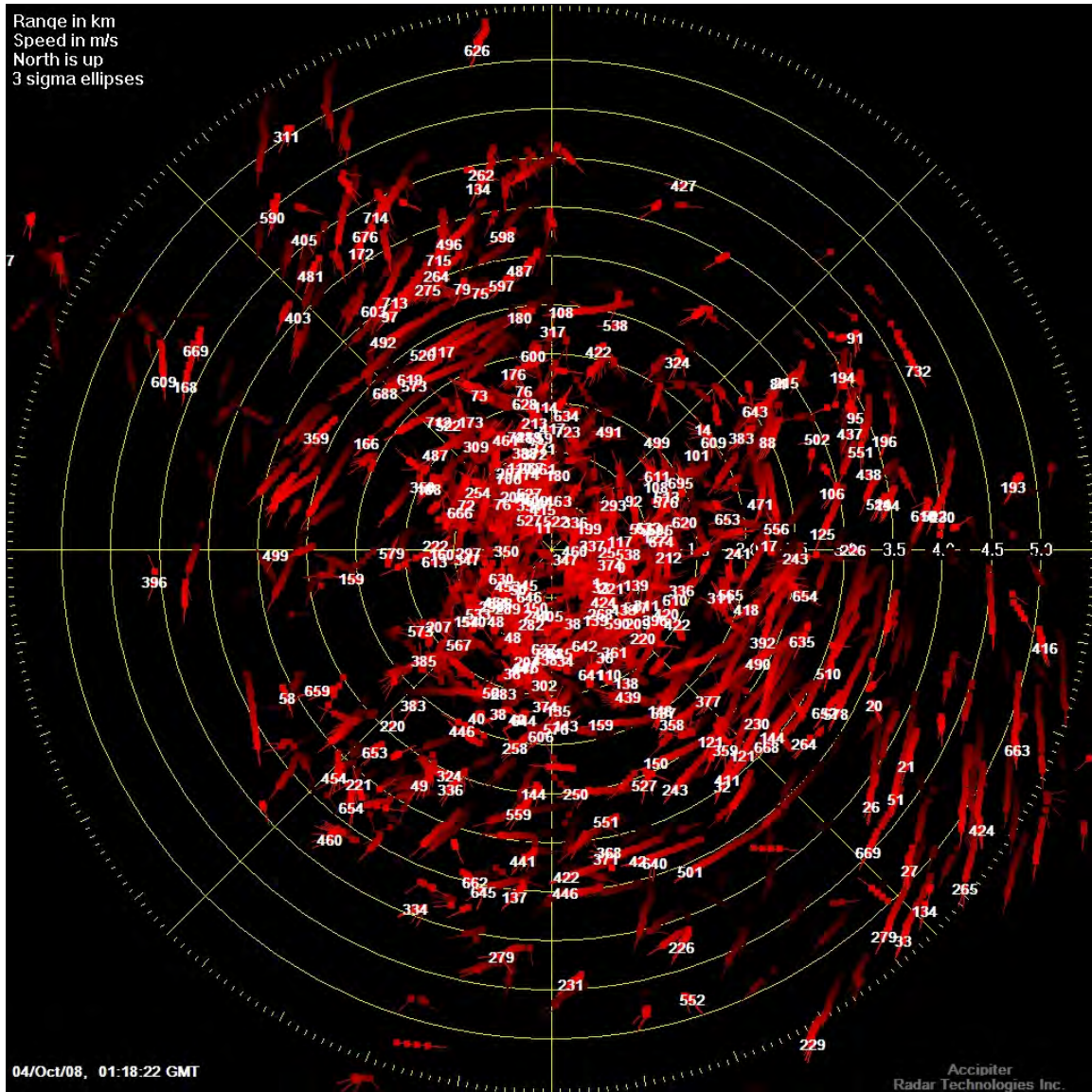

Figure 6-22. The tracks of 234 targets recorded during a single rotation of the eBirdRad avian radar antenna at Edisto Island, South Carolina on 4 October 2009, between 01:18:20 and 01:18:22 UTC. Tracks with white numeric labels (Track_ID) were included in count of total targets; those with no label are targets that were no longer being tracked by the radar and were not included in the total.

Table 6-10. The parameters of targets being tracked simultaneously at Edisto Island, South Carolina on 4 October 2008 between 01:18:20 and 01:18:22 UTC (i.e., a single antenna revolution). The data listed in this table are for the first ten and the last ten tracks of the 234 tracks displayed in Figure 6-22.

Date	Track ID	Update Time	Range (m)	Azimuth (deg.)	Height (m)	Heading (deg.)	Speed (m/s)	Latitude	Longitude
10/4/2008	0	1:18:21	748	106	256	347	7.8	32.5611	-80.2897
10/4/2008	1	1:18:21	586	126	200	249	6.4	32.5598	-80.2923
10/4/2008	3	1:18:20	502	17	172	26	8.0	32.5672	-80.2958
10/4/2008	11	1:18:20	249	338	85	30	2.6	32.5650	-80.2983
10/4/2008	14	1:18:20	1965	53	672	289	5.5	32.5735	-80.2806
10/4/2008	17	1:18:21	2234	90	764	346	22.2	32.5628	-80.2735
10/4/2008	20	1:18:21	3643	116	1246	154	11.8	32.5487	-80.2623
10/4/2008	21	1:18:21	4235	121	1448	197	11.0	32.5431	-80.2587
10/4/2008	25	1:18:21	2610	122	893	198	11.2	32.5504	-80.2738
10/4/2008	26	1:18:21	4169	129	1426	190	11.2	32.5393	-80.2627
214 records deleted – see									
10/4/2008	703	1:18:22	576	331	197	53	9.9	32.5675	-80.3003
10/4/2008	706	1:18:22	826	328	283	29	6.0	32.5692	-80.3020
10/4/2008	712	1:18:22	1718	319	588	276	5.9	32.5746	-80.3093
10/4/2008	713	1:18:22	2986	328	1021	221	14.0	32.5858	-80.3140
10/4/2008	714	1:18:22	3835	332	1312	216	9.5	32.5935	-80.3163
10/4/2008	715	1:18:20	3217	339	1100	182	10.6	32.5900	-80.3094
10/4/2008	721	1:18:20	1189	347	407	247	11.1	32.5733	-80.3002
10/4/2008	723	1:18:20	1195	9	409	330	6.5	32.5736	-80.2954
10/4/2008	732	1:18:20	4144	63	1418	152	19.2	32.5796	-80.2579
10/4/2008	734	1:18:20	1280	51	438	320	4.1	32.5701	-80.2867

Conclusion

We have demonstrated that the eBirdRad digital avian radar system can simultaneously track many more targets than the 100+ threshold we set as the success criterion for PA3.1. This capability is important in its own right, but particularly important because the highest densities of birds in flight often occur during migration; many species migrate at night when other forms of sampling are ineffective.

6.1.1.4 Tracks Single Large Birds on Airfield [PA4.1]

Objective

Performance Criterion PA4.1, Tracks Single Large Birds on Airfield, was designed to demonstrate that avian radar systems can detect, within the perimeter of most military airfields, individual birds in the size range that is of greatest concern in bird-aircraft collisions.

To demonstrate this capability, the IVAR team established as its Success Criterion (**Table 3-1**) that the eBirdRad system is capable of tracking individual raptor-sized birds out to a range of 2 km with and acceptable uncluttered display.

Methods

As a starting point to demonstrate Performance Criterion PA4.1, we chose data collected during the March-April 2007 studies at MCAS Cherry Point (MCASCP). This location is the largest of the military airfields in the IVAR study and has the most Visual Team (VT) observation sites that are 2 km or more from the radar. **Figure 4-2** shows the location of the eBirdRad radar (“RT-1”) and the Visual Team (“VT-x (’07)”) observation sites at MCAS Cherry Point (MCASCP) during the spring 2007 study. The complete method description is provided in Appendix B.

We began by selecting from the RT observations field data a subset of confirmed targets that were estimated— by adding the distance from the radar to the VT site and from the site to the target – to be $2.0 \text{ km} \pm 0.2 \text{ km}$, or more, from the radar. We further restricted this subset to solitary targets (Quantity = 1) and taxonomically identified targets (in order to judge the size of the target). The Track IDs from this final set of targets were then compared to the plots and tracks data recorded by the DRP to determine the measured ranges of these targets from the radar.

Results

Table 6-11 includes the distance, bearing, and direction of the VT sites from the radar as computed from latitude and longitude of these sites. For those observations where the VT site is between the radar and the target, column **Beyond VT Site (km)** indicates how much further beyond that site a target would have to be to be selected as a candidate. For VT sites that were already 2.2 km or more from the radar, and the target was between the VT site and the radar, column the **Between RT & VT Site (km)** indicates how much closer to the radar the target could be and still be 2.2 km or more from the radar. For example, VT Site #1 is 3.3 km from the radar: Any confirmed targets beyond this site, or any targets that were between it and the radar and 1.1 km or less from the VT site, were selected as a candidate for demonstrating Performance Criterion PA4.1.

Table 6-11. The position of Visual Team (VT) sites relative to the radar at MCAS Cherry Point, plus the computed distances targets must be beyond the VT site or between the radar and the VT sites to be 2.2 km from the radar.

Site	Position of VT Site Relative to Radar			Distance Target Must Be	
	Distance (km)	Bearing (Deg)	Direction	Beyond VT Site (km)	Between Radar & VT Site (km)
VT Site #1	3.3	312	NW	0	1.1
VT Site #1A	1.9	318	NW	0.3	N/A
VT Site #2	3.2	35	NNE	0	1.0
VT Site #2A	1.7	34	NNE	0.5	N/A
VT Site #3	2.1	148	SSE	0.1	N/A
VT Site #3A	1.2	157	SSE	1.0	N/A
VT Site #4	2.9	231	SW	0	0.7
VT Site #4A	2.0	229	SW	0.2	N/A
VT Site #5	1.0	319	NW	1.2	N/A

This selection process yielded 15 targets from the 384 that were confirmed during the spring 2007 validation studies at MCASCP. Three of the selected 15 targets could not be used because they were observed during the first portion of Session 12 on 4 April 2007, when the DRP was not recording data. Two of the remaining targets could not be used because their Track ID was not recorded on the field data sheet, and thus the field observations could not be matched with the plots & tracks data from the radar.

Table **6-12** summarizes the 10 visually confirmed solitary targets that were 2.2 km or more from the radar and taxonomically identified. The dates and times reported in

Table **6-12** are local (Eastern Standard Time on 30-31 March; Eastern Daylight Time on 1-4 April). The Updates field reports the number of scans of the radar in which the target was tracked, where successive scans are approximately 2.5 seconds apart. Thus, the first target, Track ID 22637, would have been on the radar operator's screen for over a minute (28 updates x 2.5 s/update = 70 s).

Not too surprisingly given the distances involved, all of the birds listed in

Table 6-12 are large species. This adds the final element of the PA4.1 performance criterion; namely, that the target be “raptor-sized”.

Table 6-12. Solitary targets at MCAS Cherry Point that were tracked by eBirdRad at a distance of 2 km or more from the radar and visually confirmed to be birds.

Field Records						Radar Records			
Date	Time	Session	RFC	Species	VT Site	Track ID	Range (km)	Updates	Speed (m/s)
3/30/2007	18:54:14	3	33	Unidentified Gull	VT1	22637	3.6	28	22
3/31/2007	13:18:47	5	48	Turkey Vulture	VT2A	64755	3.3	15	5
4/1/2007	9:27:38	6	32	Turkey Vulture	VT3	28698	2.5	31	8
4/1/2007	18:54:00	7	43	Turkey Vulture	VT3A	44279	3.0	51	21
4/1/2007	19:24:15	7	62	Osprey	VT2A	59209	3.2	24	11
4/2/2007	11:36:19	8	4	Turkey Vulture	VT5	7434	3.2	7	15
4/2/2007	12:52:10	8	32	Turkey Vulture	VT2A	58523	2.6	18	14
4/2/2007	18:29:14	9	24	Turkey Vulture	VT3	28917	2.2	28	8
4/4/2007	10:16:30	12	56	Common Loon	VT3	29979	2.7	50	33
4/4/2007	10:30:58	12	65	Turkey Vulture	VT3	34710	2.9	34	30

Figure 6-23 through Figure 6-32 provide a pictorial representation of the tracks of these 10 confirmed targets. In the figures the tracks of the targets are depicted as a series of black and white squares, one square for each time (Update) that target was detected on that track. The colors surrounding the black center of the squares have the following meanings:

Table 6-13. Key to color-coded update squares in Figure 6-23 through Figure 6-32.

Color	Meaning
White	Regular update of track
Blue	First update of track
Green	Last update of track
Red	Update when track was confirmed by VT
Brown	Track confirmed on last update

A line drawn from the blue to the green (or brown square) in a figure would indicate the general direction of flight, whether the target is following a more-or-less straight flight path (e.g., Figure 6-23) or circling (e.g., Figure 6-24).

The figures have been zoomed and cropped to show the position of the target relative to both the radar and the VT site that confirmed the target (as noted in the figure caption). Only the VT sites

that were staffed during a session are shown in the figures. Thus, for example, in Figure 6-23 the first update of Track ID #22637 is the blue square near the center-left of the figure, and the last update is the green square almost due west of the VT1 site – one of the five sites staffed during Session 3. The target was confirmed (red square) at 18:54:14 EST by VT1 as the target was about to pass over the Slocum Road bridge.

Figure 6-23 through Figure 6-32 also help to illustrate both the geometry and consistency of the Performance Criterion PA4.1 demonstration. For example, Table 6-11 reports site VT1 is 3.3 km from the radar, while

Table **6-12** indicates that the confirmed target T22637 is a little further from the radar, at 3.6 km. These spatial relationships are apparent in **Figure 6-23**. Not included in these tables and figures is the fact that the RFC reported this target as a half mile southwest of site VT1 – again apparent in **Figure 6-23**. The visual observer identified the target as a gull, which is consistent with the speed at which the radar tracked the target (22 m/s), the more or less straight flight path, and the fact that it is headed north-northeast toward the Neuse River.

In another example, target T64755 was detected 15 times (

Table **6-12**) but its computed speed was only 5 m/s. This is consistent with the known behavior of the observed species (Turkey Vulture) and the fact that the observation was made in an early spring afternoon (1:18 PM), when the sun is warming the land and creating thermal updrafts that soaring birds follow in tight circles (i.e., “thermal soaring”) to gain altitude. This behavior is apparent in the close spacing and almost vertical stacking of the update squares in **Figure 6-24**. Compare this to another Turkey Vulture, T44279 that was observed during the early evening (6:54 PM) after the thermals had broken down: It was tracked at a speed of 21 m/s, covering a distance of 2.5 km.

Conclusion

The observations summarized in

Table 6-12 and depicted in **Figure 6-23** through Figure 6-32 clearly demonstrate the eBirdRad avian radar system meets Performance Criterion PA4.1: it is able to detect and track solitary raptor-sized birds at, and in some cases well beyond, the 2 km radius that would encompass the perimeter of most military airfields.



Figure 6-23. The track of target T22637 (unidentified gull) at MCAS Cherry Point on 30 March 2007. This target was confirmed by visual team VT1. Track update colors: **blue** = start, **red** = confirmed, **green** = end.



Figure 6-24. The track of target T64755 (stack of squares in upper-right corner), a Turkey Vulture, at MCAS Cherry Point on 31 March 2007. This target was confirmed by visual team VT2A. Track update colors: **blue** = start, **brown** = confirmed on last update.



Figure 6-25. The track of target T28698 (Turkey Vulture) at MCAS Cherry Point on 01 April 2007. This target was confirmed by visual team VT3. Track update colors: **blue** = start, **red** = confirmed, **green** = end.



Figure 6-26. The track of target T44279 (Turkey Vulture) at MCAS Cherry Point on 01 April 2007. This target was confirmed by visual team VT3A. Track update colors: blue = start, red = confirmed, green = end.



Figure 6-27. The track of target T59209 (osprey) at MCAS Cherry Point on 01 April 2007. This target was confirmed by visual team VT2A. Track update colors: blue = start, red = confirmed, green = end.



Figure 6-28. The track of target T7434 (stack of squares near center-top of image), a Turkey Vulture, at MCAS Cherry Point on 02 April 2007. This target was confirmed by visual team VT5.. Track update colors: blue = start, brown = confirmed on last update.



Figure 6-29. The track of target T58523 (Turkey Vulture) at MCAS Cherry Point on 02 April 2007. This target was confirmed by visual team VT2A. Track update colors: blue = start, brown = confirmed on last update.



Figure 6-30. The track of target T28917 (Turkey Vulture) at MCAS Cherry Point on 02 April 2007. This target was confirmed by visual team VT3. Track update colors: blue = start, red = confirmed, green = end.



Figure 6-31. The track of target T29979 (common loon) at MCAS Cherry Point on 04 April 2007. This target was confirmed by visual team VT3. Track update colors: **blue** = start, **red** = confirmed, **green** = end.



Figure 6-32. The track of target T34710 (Turkey Vulture) at MCAS Cherry Point on 04 April 2007. This target was confirmed by visual team VT3. Track update colors: blue = start, red = confirmed, green = end.

6.1.1.5 Tracks Birds Beyond Airfield [PA5.1]

Objective

We designed Performance Criterion PA5.1 as a companion to PA4.1: The latter (Section 6.1.1.4) was designed to demonstrate that the avian radar systems the IVAR project is evaluating can track birds within the perimeter of most military airfields. Performance Criterion PA5.1 was

intended to demonstrate these systems can also track birds and other targets beyond the perimeter of those facilities.

Methods

We chose MCASCP for the demonstration of PA5.1 for much the same reason as we chose it for PA4.1 (Section 6.1.1.4) – it’s the largest of the military airfields used in the IVAR studies, and one of the largest in the world.

We began by outlining the perimeter of the MCASCP facility using the Alarms function of the TVW application. Within this perimeter, we masked the central 1 km radius to reduce the returns from ground vehicles and other targets close to the radar.

The data we chose for this demonstration were collected during the fall 2008 visual confirmation study at MCASCP; specifically, they were collected on 6 October 2008, between 15:18 to 17:30 GMT (08:18 to 10:30 EDT) – see Section 6.1.1.1.1. We played back the dataset for this date/time through the TVW software, with the TVW configured to display the targets’ Track ID number, and generated screen captures of the display to illustrate birds well beyond the perimeter of the airfield.

Results

Figure 6-33 through **Figure 6-35** present three examples of birds tracked by the radar beyond the perimeter of the MCASCP airfield (green line in each figure). Given the irregular shape of the MCASCP facility, and the location of the eBirdRad radar within the facility, some targets that are outside the perimeter are less than 2 km from the radar. However, the targets that we selected to demonstrate this criterion are all 5-6 km from the radar. These targets would have been outside the perimeter of all but the far northwest portion of the MCASCP facility.

While no birds were tracked beyond the far northwestern corner of the MCASCP facility in the dataset we selected for this demonstration, Performance Criterion SB3.1 (Section 6.2.1.3) will demonstrate the ability of the eBirdRad radar to track birds out to ranges of 11 km or more - well beyond the perimeter of most military airfields.

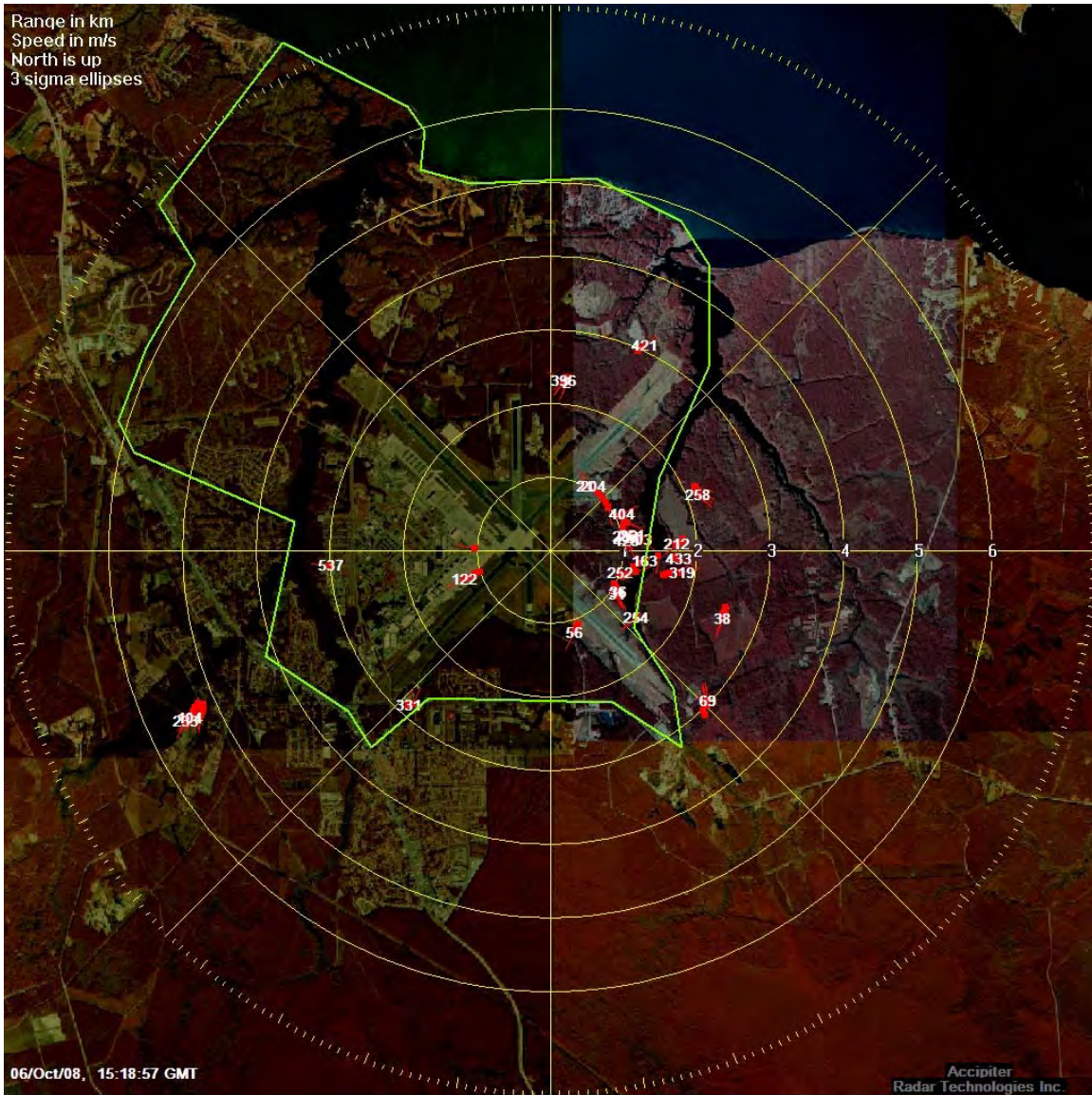

Figure 6-33. Screen capture of birds to the southwest of the radar that are well beyond the perimeter of the MCASCP airfield (outlined in green). These track data are from 6 October 2008. The track labels are the targets' Track ID.

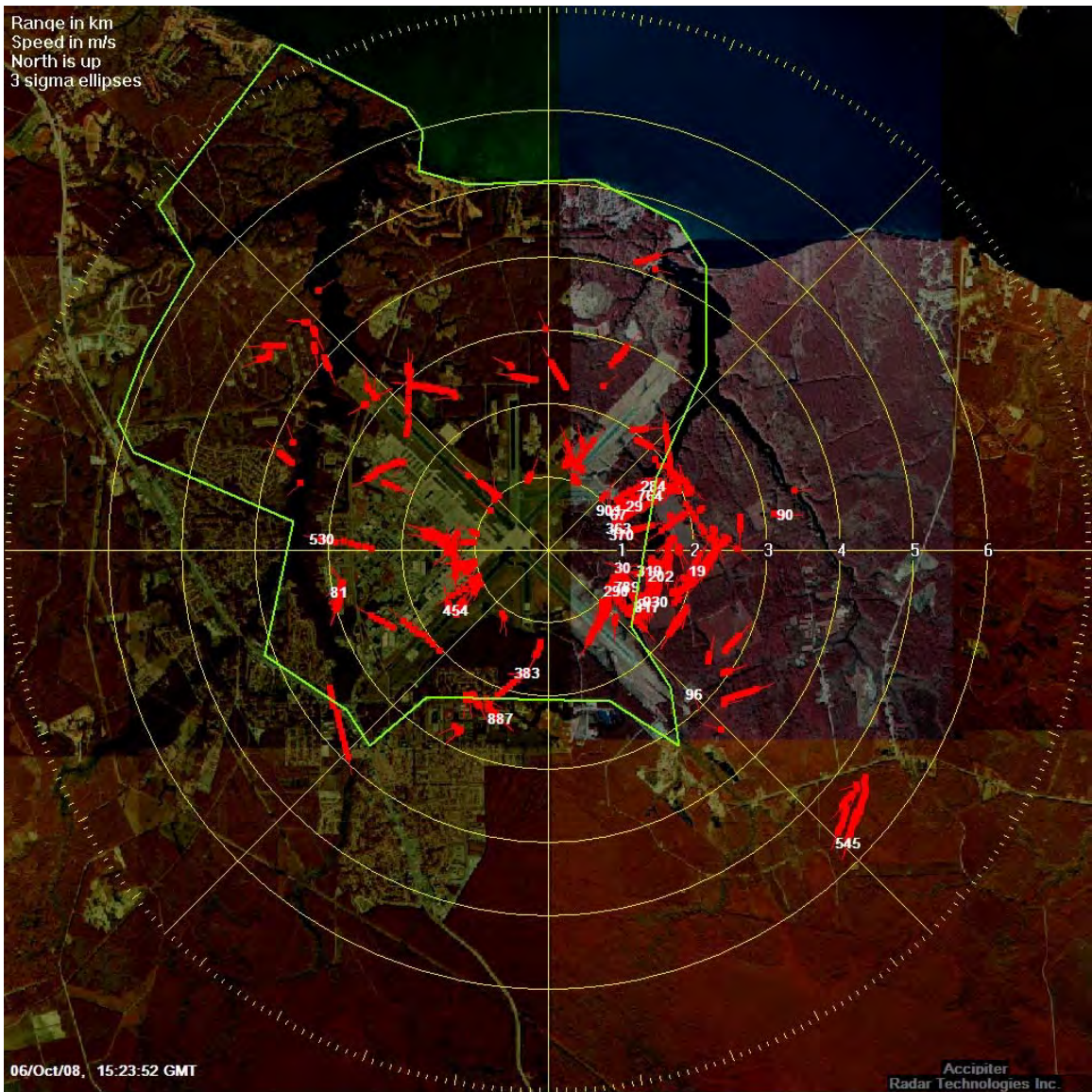

Figure 6-34. Screen capture of birds to the southeast of the radar that are well beyond the perimeter of the MCASCP airfield (outlined in green). These track data are from 6 October 2008. The track labels are the targets' Track ID.

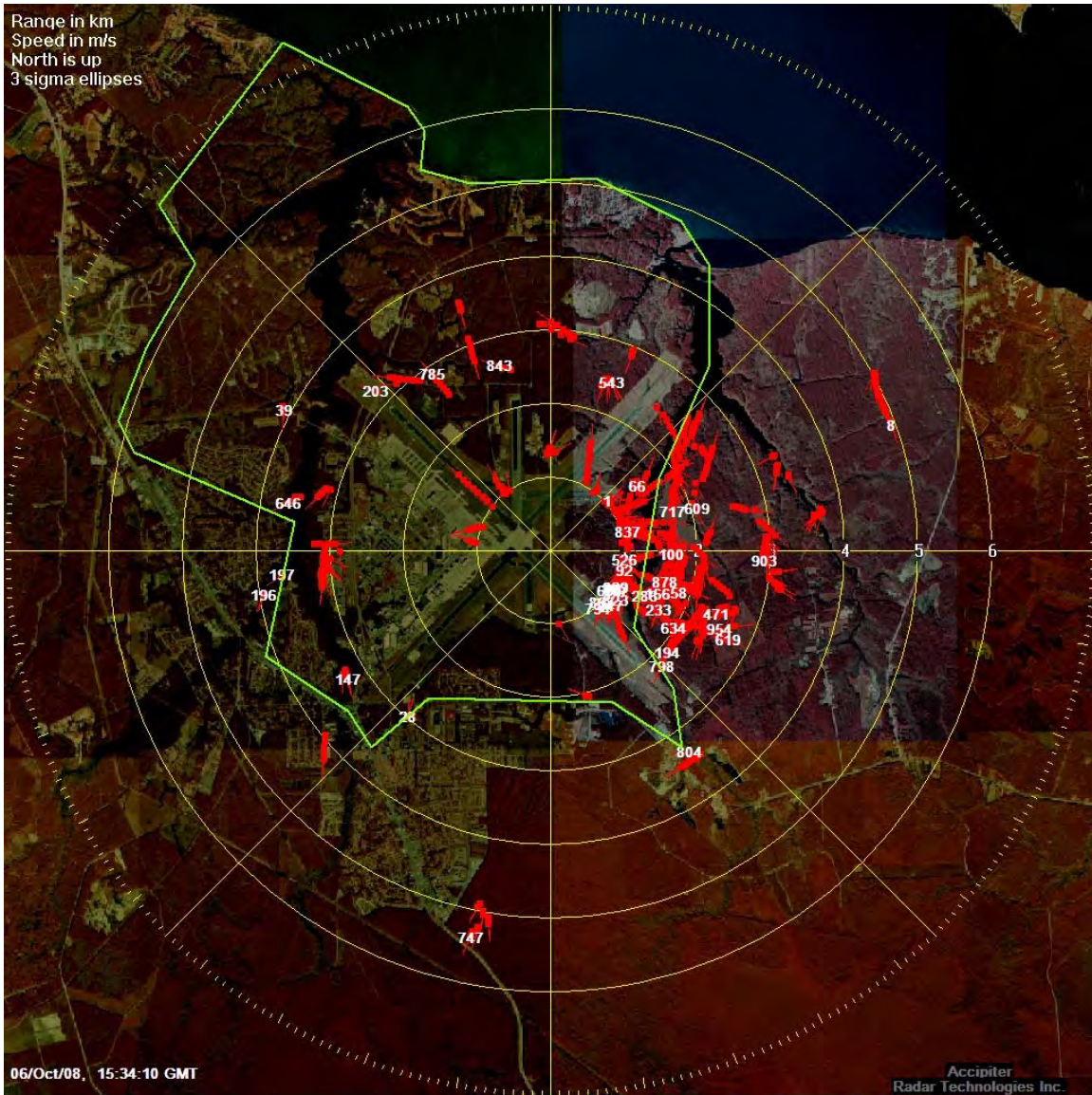

Figure 6-35. Screen capture of birds to the south and northeast of the radar that are well beyond the perimeter of the MCASCP airfield (outlined in green). These track data are from 6 October 2008. The track labels are the targets' Track ID.

Conclusion

We have successfully demonstrated PA5.1: **Figure 6-33** through **Figure 6-35** demonstrate the radar systems evaluated by the IVAR project can detect and track birds out to 5 km range and up to 3 km beyond the airfield perimeter.

6.1.2 Qualitative Performance Criteria

6.1.2.1 Automates Real-Time Tracking of Radar Echoes [PA1.2]

Objective

We designed Performance Criterion PA1.2, Automates Real-Time Tracking of Radar Echoes was to demonstrate that the digital avian radars being evaluated by the IVAR project can automatically discriminate the echoes of moving targets from the analog waveform data returned by the marine radars used by most avian radar systems. Our objective was to demonstrate that these systems can detect and track in real time the same targets that a human operator would detect when observing the same radar display.

We set the success criterion for the qualitative PA1.2 criterion that the detection and tracking of these targets would be “Achievable”.

Methods

We chose to demonstrate criterion PA1.2 using the eBirdRad avian radar system because it uses the same transceiver (Furuno 2155BB) and 4° dish antenna as its analog BirdRad predecessor, but with the addition of the Accipiter® DRP that performs the automatic detection and tracking functions. We divided the task of demonstrating that the eBirdRad can automatically track radar echoes in real time into two segments. For the first segment, Validation by Simulation, we used an in-house software simulation tool to validate that the automatic tracking algorithms used in the eBirdRad DRP track sequences of detections are consistent with avian target dynamics. This simulation tool produces a plot file of the same format as does the DRP when operating in real time and can be replayed for off-line re-processing (i.e., re-tracking). Thus, our testing methodology for PA1.2 made use of the actual radar systems under test to validate the capabilities of the automatic tracking algorithms.

The plots file we simulated for the purpose of this validation includes the following targets and dynamics:

- A total of twenty (20) simulated targets are “flying” simultaneously, with speeds around 15 m/s – emulating typical bird speeds.
- The targets are organized into four groups with 4 to 6 targets in each group.
- For certain times during the simulation, the targets are far enough apart to simulate a separated target tracking scenario.
- For certain times during the simulation, targets are crossing to simulate a target-crossing tracking scenario.
- For certain times during the simulation, targets are converging to simulate a converging target tracking scenario.
- For certain times during the simulation, targets maneuver to simulate a maneuvering target tracking scenario.
- For certain times during the simulation, targets are diverging to simulate a diverging target tracking scenario.

These motion dynamics are consistent with single birds and flocking birds. We designed them to demonstrate the inherent automatic tracking capabilities of the Multiple Hypothesis Testing

(MHT) and Interacting Multiple Model (IMM) tracking algorithms (Blackman 2004) that are employed in the advanced avian radars we evaluated on the IVAR project.

For the second part of the demonstration, Validation by Image Comparison, we compared screen images of the same targets that the radar operator would see using the analog BirdRad (or comparable) avian radar system with those the operator (or the detection and tracking software) would see using the digital eBirdRad system. We present those comparisons in Figure 6-39 through Figure 6-42.

The images we used in this demonstration were captured at NAS Patuxent River, following the evening session on 17 April 2007, at approximately 23:48 UTC (19:48 EDT). The raw radar returns from the Furuno 2155BB radar at NASPR were split and fed both the BirdRad and eBirdRad simultaneously. Thus, both the analog BirdRad and digital eBirdRad systems processed the same data as input.

In the figures below, the radar is located at the center of the display, the maximum range on both the BirdRad and eBirdRad units is set to 5.6 km (3.0 nmi), the range rings are either 0.9 km (0.5 nmi) (BirdRad) or 0.6 km (0.3 nmi) (eBirdRad) apart, and true north (000 degrees) is at the top of the display.¹⁵

Results

Validation by Simulation.

The green circles in **Figure 6-36** through **Figure 6-38** indicate simulated bird detections; successive green circles represent the history of several radar scans and indicate bird movements from scan to scan. The brightest green circles represent the most recent location of the simulated targets, with a gradation to darker shades representing older or past scans. The red symbols represent the targets the DRP is automatically tracking: The red square at the center is the target's most recent location, and the red line points in the direction the target is moving (i.e., its heading). The white numbers overlaying the red squares are the targets' estimated speed in knots. The scale of the range markers is indicated on the horizontal axis, in nautical (1 nmi = 1.8 km) from the radar. The simulation time frame is on the order of 10 minutes from start to finish.

In all scenarios illustrated in **Figure 6-36** through **Figure 6-38**, the automatic tracking algorithms behave in a consistent and desirable manner when confronted with various target dynamics.

Figure 6-36 shows the targets near the beginning of the simulation: There are four groups of separated targets, each group in a different quadrant and moving in different general directions. Approximately 3 minutes into the simulation (**Figure 6-37**) the targets have progressed so that the targets in the upper left quadrant are shown crossing, the targets in the lower left quadrant have continued in formation, the targets in the upper right quadrant have started to converge, and the targets in the lower right quadrant have made a sharp maneuver and begun diverging. Three minutes later (**Figure 6-38**), the targets in the upper left quadrant have completely crossed and separated, the targets in the lower left quadrant have continued in formation, the targets in the

¹⁵ Geographic north is 10° east of the north rhumb line in **Figure 6-39** because the radar was not pointing to true north (which the display assumes), but was instead pointing 10° west of north. This cannot be corrected in the BirdRad system because it has no mechanism to rotate the image. In eBirdRad, on the other hand, the image can be rotated so that returns from strong reflectors are aligned properly with their position on the underlying geo-referenced map. This in turn aligns the display to geographic north. In this way the eBirdRad display depicted in **Figure 6-40** (and following figures) was rotated 10° counterclockwise so that geographic north is at 0°.

upper right have completely converged into a single track, and the targets in the lower right quadrant have been automatically deleted as they are no longer in the simulation.

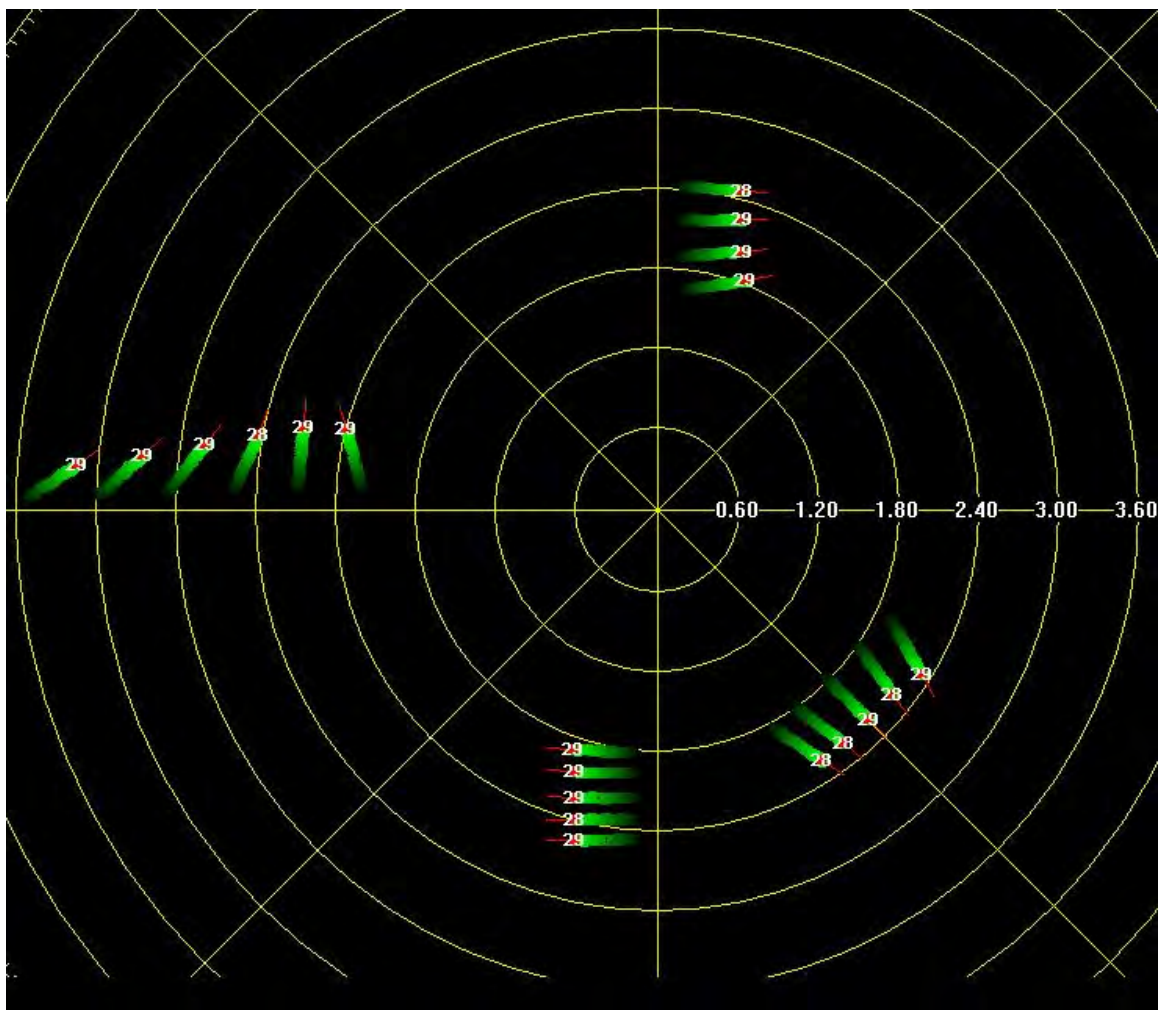

Figure 6-36. Near the beginning of the simulation, four groups of separated targets are shown. Detections (represented by green circles) as well as tracks (represented by red squares) are indicated above. The numbers represent the target's speed in knots (1 knot = ~1.8 km/hr).

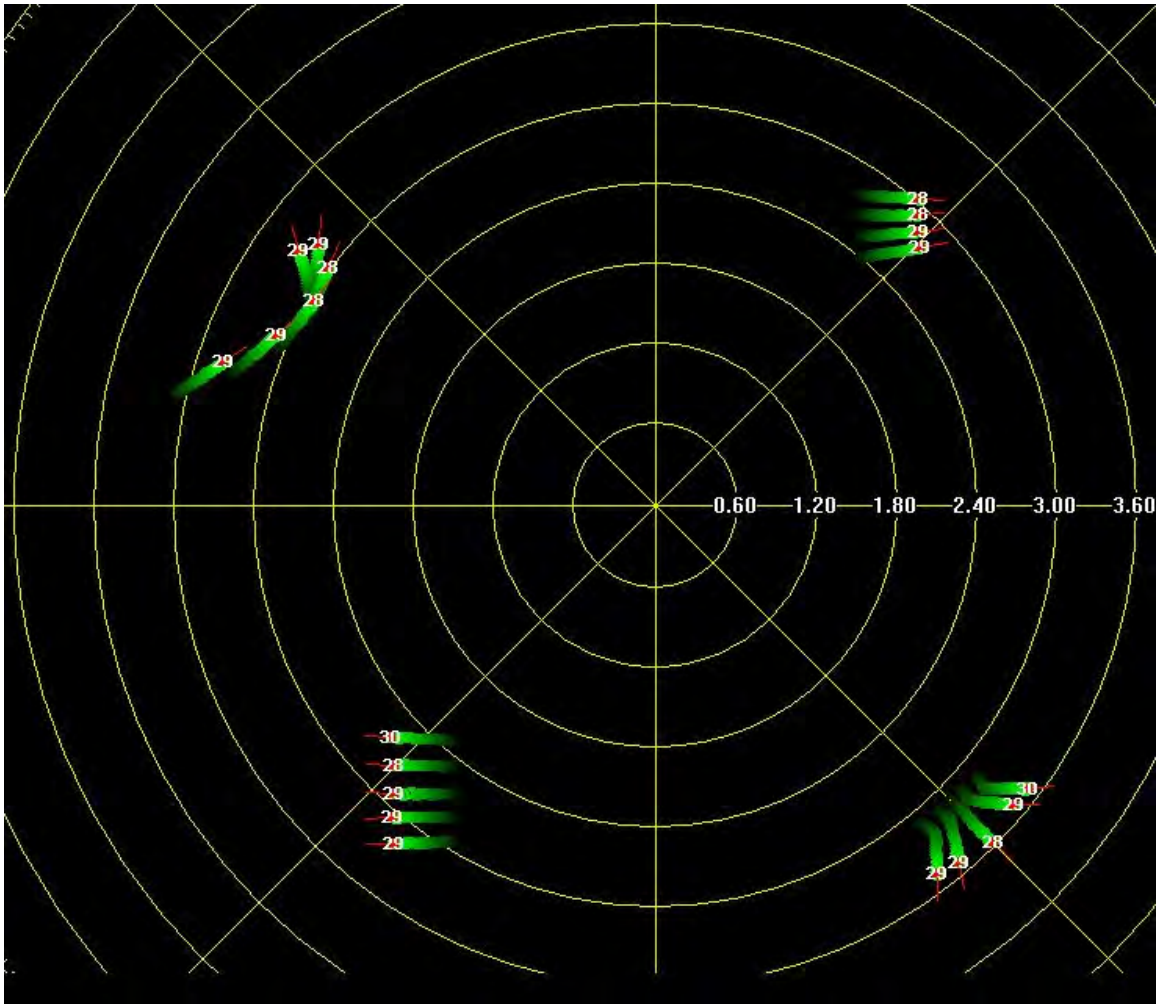

Figure 6-37. Approximately three minutes after the beginning of the simulation, the targets have progressed and exhibit different behaviors as detailed in the text.

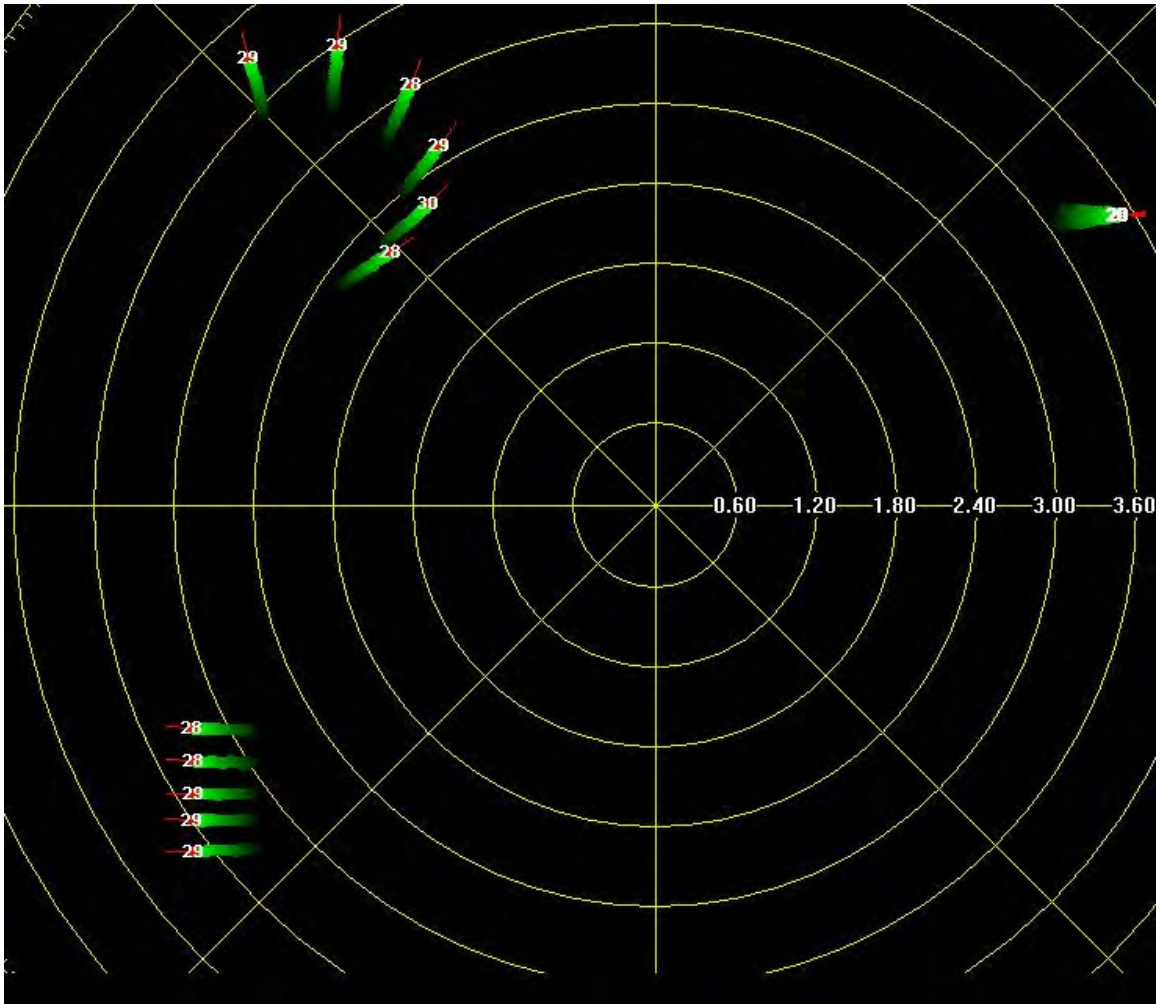

Figure 6-38. The progression of the targets three six minutes later after the beginning of the simulation.

Validation by Image Comparison.

Figure 6-39 is a picture of the analog BirdRad display generated by the Furuno 2155BB electronics and captured with a Foresight video capture board and software (see **Figure 2-2**). We selected the 2155BB’s “True Trail” mode so that the radar returns from the current scan are displayed in yellow and up to 15 prior returns are displayed in increasingly dark shades of blue. The current returns (yellow) overwrite (and mask) the blue of prior scans (see Section 2.4.2 for a discussion of the True Trail mode).

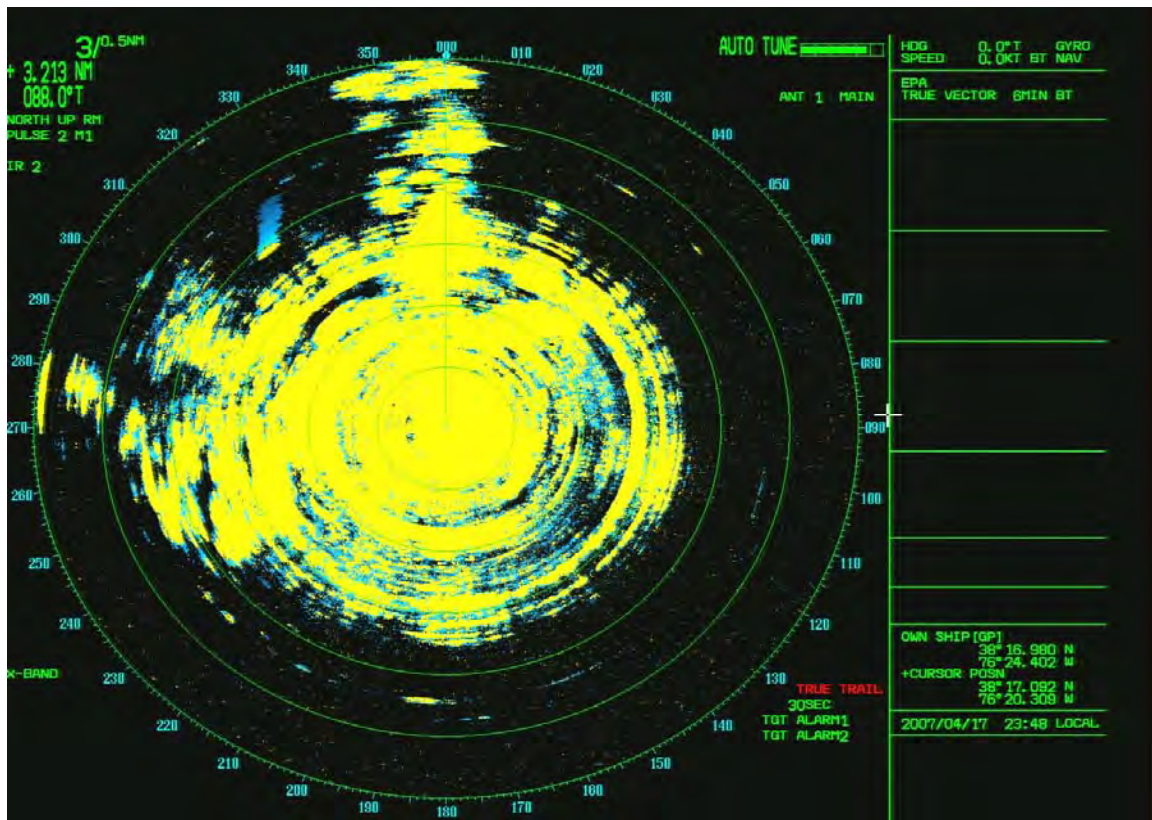

Figure 6-39. BirdRad display, NAS Patuxent River, 17 April 2007, 23:48 GMT. Yellow areas are returns from the current scan of the radar; blue areas are returns from prior scans of the radar.

Most long-time radar ornithologists would be familiar with an image like Figure 6-39. Ground clutter from stationary objects (displayed as yellow in the current scan; see “True Trail” above) obscures most of the area within a 2 nmi (3.7 km) radius of the radar. Any target moving within this clutter region is hidden from view, both because the target’s current position (yellow) is lost in a sea of yellow from the ground clutter objects, and because the blue of the target’s prior positions is masked by the yellow of clutter from the current scan. These difficulties notwithstanding, a moving target is clearly visible in Figure 6-39 as a yellow “head” (current position) with a blue tail (prior positions) at a bearing of approximately 320° (NW) and a range of 1.9 nmi (3.5 km) from the radar. The target is moving in a roughly southerly direction, based on the position of head relative to the tail of the target.

The eBirdRad Accipiter® DRP image in Figure 6-40 was generated by digitizing the same raw analog radar signal the Furuno 2155BB used to generate the image depicted in Figure 6-39. Figure 6-40 is, in effect, a digital rendering of the analog image displayed by BirdRad, with the addition that the radar returns are overlain on a satellite image of the surrounding locale – here, the NAS Patuxent River facility. The digital rendering employs the same convention of yellow for echoes from the current scan of the radar, increasingly darker shades of blue for echoes from prior scans, with yellow overwriting blue. Comparing Figure 6-39 and Figure 6-40, it is evident that the distribution and abundance of clutter in both images are remarkably similar, as are the position and shape of the lone mobile target visible in the upper-left quadrant of both images.

The slight difference in alignment between the images is due to the misalignment of the BirdRad image from geographic north (see Footnote #15).

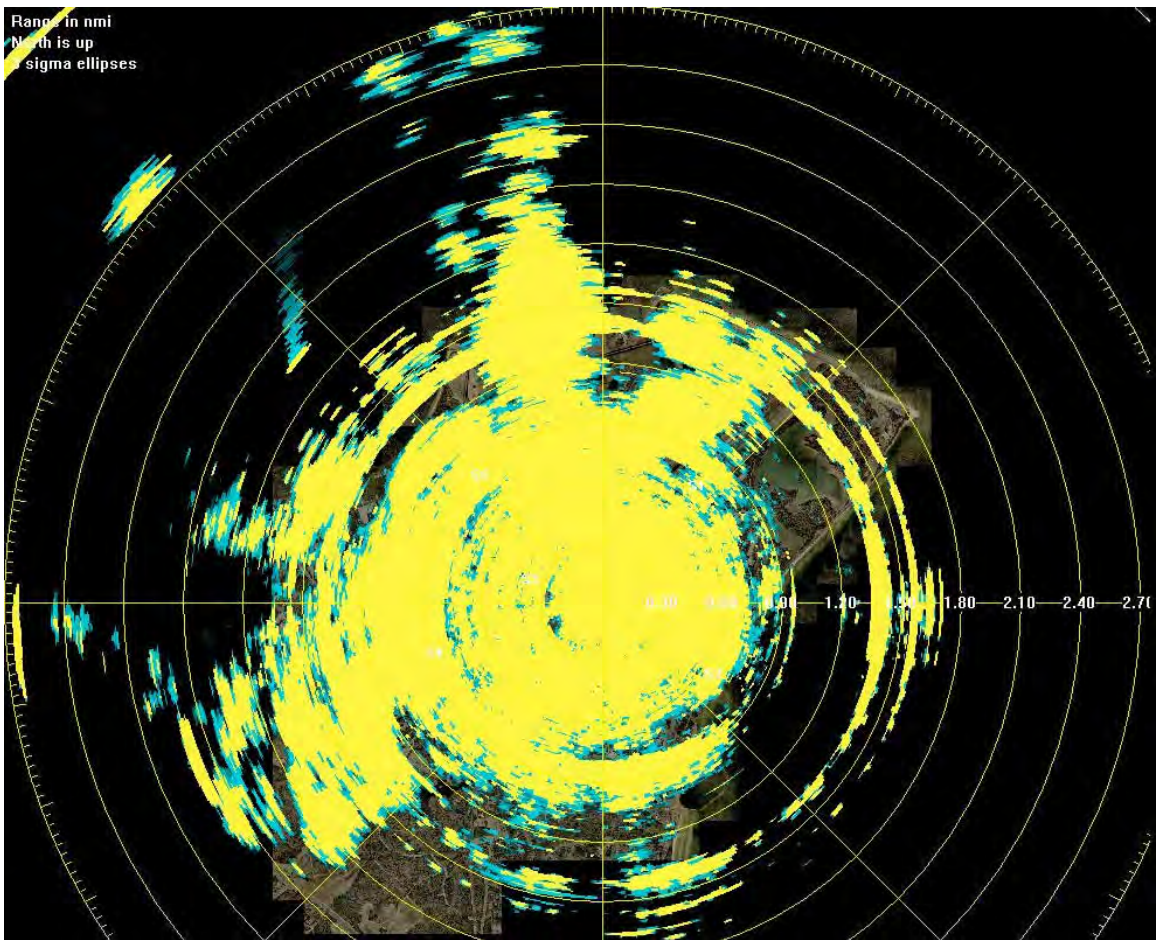

Figure 6-40. eBirdRad display. Same data and display characteristics as Figure 6-39, but processed and rendered digitally.

Figure 6-41 is based on the same data, with the same true trails mode as Figure 6-40, except that the ground clutter has been suppressed with clutter-map processing. The same target in the upper-left quadrant is still quite visible – perhaps more so because of the greater contrast with the background. With most of the clutter removed, small patches of blue are now visible in the area that was previously completely yellow. Most of the blue patches are probably residuals from variations in the amplitude of the signals within the clutter. However, a faint blue echo trail can be seen near the center of the picture, generally moving northwest to southeast along the runway.

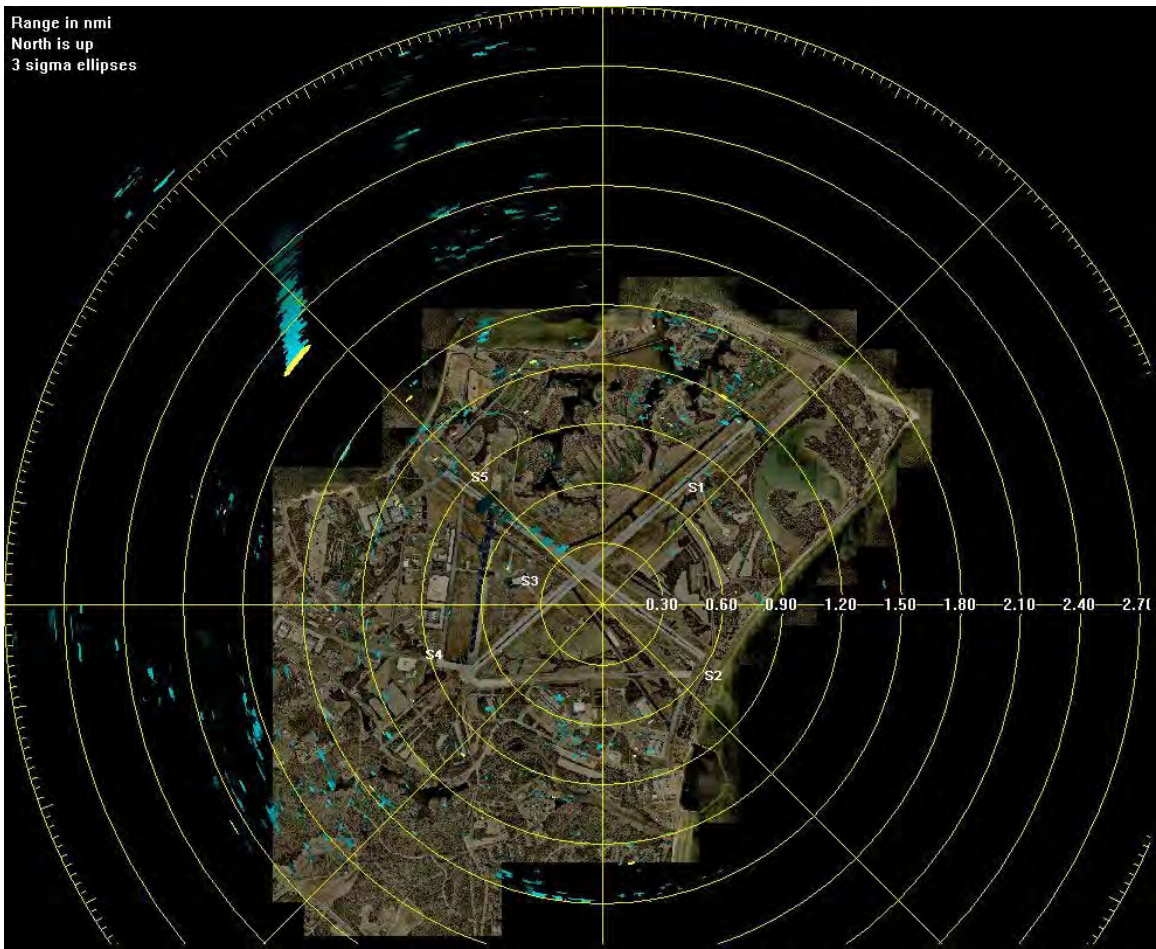

Figure 6-41. eBirdRad display based on the same data and display characteristics as Figure 6-40, but with clutter suppressed.

As noted in Section 2.4.2, Furuno’s True Trail mode used by the analog BirdRad system is not true tracking. The color-coded display simply provides visual cues for the human observer to recognize moving targets and from this to decide if those targets might be birds. The same is true for the digital emulation of this mode by the DRP in the eBirdRad system. Figure 6-41, on the other hand, represents true real-time automatic tracking of mobile targets by the Accipiter® DRP. Each red trail¹⁶ on the screen represents a series of detections (“plots”) that were strong enough and consistent enough from one scan of the radar to the next that the MHT/IMM tracking algorithms associated them together and filtered them into a “track.”

¹⁶ The display and color of both “plots” (detections) and tracks, as well as their histories, are user-configurable in the eBirdRad system. In Figure 6-36 through Figure 6-38, the current position of each simulated target is displayed in red and represents the current position of the tracked target. The tails are the prior detections of each target that were used to compute the track, and are displayed in green. In Figure 6-40 through Figure 6-42 both the head and the tail are the current and prior track positions, respectively, of the target, and are both displayed in red.



Figure 6-42. eBirdRad display based on the same data as Figure 6-41, with true trail mode turned off and automatic tracking and track history turned on. The red trails are the positions (“history”) of the target while it was being tracked; the white label at the head of a track is the target’s Track ID.

Again, the same strong target that was visible in the preceding four figures was detected and tracked by the DRP in Figure 6-42. The white label “375” on the track is the target’s Track ID. We set the eBirdRad display to show a track history of one minute (24 scans at 2.5 seconds/scan), approximately the scan history shown in the BirdRad display. However, as will be discussed below, the radar tracked this target for 36 scans, or ~1.5 minutes. It’s also important to note that this target is nearly 3.7 km from the radar, a distance that is near or beyond the limit of a human observer’s ability to detect the target visually (see Criterion PA4.1, Section 6.1.1.4).

Figure 6-42 also demonstrates that digitally processing radar returns can detect and track targets in real time that were not visible to the observer of the analog display. The red tails of thirteen more targets can be seen in this figure – eight with Track IDs indicating they are still being tracked, and five with red tails but no heads, indicating they are the remnants of tracks that are no longer being detected.

Another advantage of tracking targets digitally is the wealth of information that can be generated about the target in real time. **Figure 6-43** and **Figure 6-44** display some of the data that are

available for each target tracked by eBirdRad¹⁷. The first (highlighted) record in **Figure 6-43** is for Track ID 375, the target shown in Figure 6-42. The value “36” under the Number of Updates column indicates this target was tracked for 36 scans of the radar - approximately 90 seconds at 2.5 seconds/scan.

Date	Track ID	Start Time	Duration (s)	Number of Updates	Start Range (m)	Start Azimuth (deg.)	Intensity	Start Headin...	Start Speed (m/s)
04/17/07	375	23:47:48.203	111.43	36	4398.91	318.1	1654	162.1	16.5
04/17/07	378	23:47:50.984	62.86	19	1206.82	311.7	1509	120.9	17.7
04/17/07	717	23:49:00.843	45.71	13	820.24	10.3	1647	37.2	16.4
04/17/07	447	23:48:07.843	31.43	7	2963.49	235.2	1236	139.6	7.4
04/17/07	280	23:47:25.781	25.71	7	2721.21	259.0	1294	348.1	16.5
04/17/07	276	23:47:28.593	25.71	7	2678.53	199.7	1314	44.8	2.2
04/17/07	533	23:48:19.15	21.82	6	2745.86	21.2	1228	108.6	6.1
04/17/07	960	23:49:59.687	31.43	5	3391.32	337.9	1286	320.6	0.6
04/17/07	674	23:48:49.656	19.09	5	1278.76	192.5	1308	146.7	11.3
04/17/07	510	23:48:16.203	20.00	5	2202.03	293.7	1269	26.4	15.5
04/17/07	209	23:47:11.765	22.86	5	2398.78	24.7	1302	52.2	6.9
04/17/07	195	23:47:06.203	20.00	5	2331.57	228.3	1253	33.8	8.7
04/17/07	182	23:47:00.578	20.00	5	3530.17	341.0	1315	65.2	17.2
04/17/07	17	23:46:29.812	20.00	5	1356.18	194.6	1254	261.4	15.8
04/17/07	918	23:49:42.859	20.00	4	2959.73	292.5	1481	174.4	19.6
04/17/07	546	23:48:30.171	21.82	4	968.15	204.4	1230	118.7	0.6

Figure 6-43. TrackDataViewer display of parametric data available for targets being tracked by eBirdRad. Track ID 375 (highlighted) corresponds to a target being tracked in Figure 6-42. The table has been truncated on the right to fit on the page¹⁸.

Figure 6-44 displays the “Detailed View” of Track ID 375. In this view each record contains the parameters measured for that target during each update (scan of the radar). Note that the records are approximately 2.5 seconds apart – the nominal scan rate of the radar.

¹⁷ This table was generated from the plots & tracks data files with a desktop utility called Track Data Viewer, but the same data could be streamed to a local or remote database and viewed with this or a variety of other applications.

¹⁸ See Section 6.1.1.2 for a listing of all the fields in the TrackDataViewer® “master” and “detail” records.

Track history for Track ID 375, start time: 23:47:48								
Time	Latitude	Longitude	Range (m)	Azimuth (deg.)	Intensity	Height	Heading (deg.)	Speed (m/s)
23:47:50.72	38.3128	-76.4402	4398.9092	318.1154	1654	383.4	162	16.5
23:47:53.50	38.3123	-76.4403	4357.4097	317.5656	1617	379.8	169	17.5
23:47:56.31	38.3118	-76.4403	4314.5449	317.0656	1700	376.0	171	18.1
23:47:59.13	38.3114	-76.4401	4269.7495	316.7830	1680	372.1	169	18.0
23:48:01.91	38.3108	-76.4401	4226.4834	316.2447	1734	368.4	171	18.6
23:48:04.72	38.3104	-76.4400	4188.0850	315.8675	1765	365.0	172	18.1
23:48:07.53	38.3100	-76.4400	4151.1074	315.4186	1754	361.8	173	17.8
23:48:10.34	38.3095	-76.4400	4116.0005	314.8287	1780	358.7	176	17.9
23:48:13.13	38.3090	-76.4400	4075.5127	314.3262	1681	355.2	176	18.2
23:48:15.91	38.3085	-76.4399	4033.3696	313.8902	1811	351.5	174	18.5
23:48:18.69	38.3081	-76.4397	3987.8540	313.5786	1779	347.6	171	18.6
23:48:21.49	38.3076	-76.4396	3940.0139	313.0727	1875	343.4	170	19.3
23:48:24.29	38.3070	-76.4395	3891.6790	312.5207	1965	339.2	170	20.0
23:48:27.08	38.3064	-76.4394	3843.1772	311.8691	2058	335.0	170	20.7
23:48:29.86	38.3059	-76.4393	3797.4180	311.2875	2109	331.0	170	20.8
23:48:32.63	38.3053	-76.4392	3753.9675	310.6173	2105	327.2	171	21.0
23:48:35.41	38.3048	-76.4393	3713.0059	309.8397	2121	323.6	173	21.2
23:48:38.18	38.3042	-76.4392	3671.9065	309.2233	2091	320.0	173	21.0
23:48:41.01	38.3037	-76.4391	3626.5537	308.5907	2178	316.1	173	21.2
23:48:43.78	38.3032	-76.4389	3578.7769	307.9808	2184	311.9	171	21.5
23:48:46.56	38.3027	-76.4388	3532.5740	307.3941	2145	307.9	170	21.5
23:48:49.32	38.3021	-76.4386	3488.3943	306.7804	2072	304.0	170	21.5
23:48:52.08	38.3016	-76.4385	3445.1306	306.1090	1416	300.3	170	21.5
23:48:54.87	38.3012	-76.4385	3412.2998	305.4446	1469	297.4	171	20.7
23:48:57.66	38.3007	-76.4384	3382.3591	304.7382	1544	294.8	173	20.1
23:49:00.42	38.3002	-76.4384	3348.2544	304.0407	1558	291.8	174	19.9
23:49:03.25	38.2998	-76.4382	3309.0969	303.4536	1646	288.4	172	19.7
23:49:05.99	38.2993	-76.4381	3270.3643	302.7335	1785	285.0	172	20.0
23:49:08.80	38.2988	-76.4379	3229.2136	302.1368	1832	281.4	170	19.9
23:49:11.60	38.2982	-76.4379	3189.9983	301.2114	1852	278.0	170	20.5
23:49:14.38	38.2977	-76.4380	3168.5618	300.2583	1800	276.2	175	19.9
23:49:17.18	38.2972	-76.4379	3136.5359	299.4230	1484	273.4	175	19.9
23:49:19.99	38.2967	-76.4378	3105.1702	298.5701	1377	270.6	175	19.9

Figure 6-44. A partial history of target Track ID #375 shown in Figure 6-43 (see also Figure 6-42). Each record in this table represents a separate detection of that target. The table has been truncated on the right to fit on the page¹⁸.

Conclusion

When we supplied the Accipiter® DRP with software-generated synthetic targets as input, its automatic tracking algorithms captured the complex patterns of the targets’ speed, position, and direction of flight, as evidenced by **Figure 6-36** through **Figure 6-38**.

Figure 6-39 through **Figure 6-44** demonstrate that the eBirdRad digital avian radar is able to detect and track in real time the same target echoes that a human operator would observe watching an analog avian radar display, plus additional targets that would not have been apparent to the human operator. Specifically,

- The eBirdRad digital avian radar faithfully reproduces screen images that would be familiar to a radar ornithologist experienced with analog avian radars (e.g., BirdRad). The analog radar image from BirdRad in **Figure 6-39** is nearly identical to digital rendering of the same scene at the same time generated by eBirdRad in **Figure 6-40**. **Figure 6-41** shows the same scene from eBirdRad with clutter suppressed. Both the analog and digital images display an echo from a moving target that appears to be a bird;
- The reduction of ground clutter by the digital system that is evident in **Figure 6-41** allows targets to be seen in the eBirdRad display that were not visible in the analog BirdRad display;
- The Accipiter® DRP tracking algorithms (**Figure 6-42**) automatically track the same target seen in both the analog and digital displays, plus additional targets that had been masked by clutter in the analog display;
- To track many targets simultaneously using an analog avian radar system, the display would have to be recorded (e.g., videotaped) and analyzed later – thus eliminating real-time tracking; and
- The Accipiter® DRP generates and displays a wealth of parametric data about the tracked targets in real time (**Figure 6-43** and **Figure 6-44**).

From these comparisons we conclude eBirdRad is able to automatically track radar echoes, both synthetic and those of presumptive birds recorded in the field. The other side of this question – “Are the targets that are being tracked in the field really birds?” – is discussed in Section 6.1.1.1.

6.1.2.2 Provides Reduced Clutter Compared To Analog Radar [PA2.2]

Objective

Because the beam from the antenna of an avian radar is typically oriented close to horizontal, where most flying birds are pose hazards to aviation, radar echoes from stationary objects such as the land, buildings, trees, etc. – collectively termed “ground clutter” – can be quite pronounced. This clutter can mask small targets like birds flying within it. We designed Performance Criterion PA2.2 to demonstrate that digital avian radar systems can remove (“subtract out”) much of this clutter, thereby potentially exposing more targets than would be visible to the observer of the same scene on an analog radar display.

We defined PA1.2 as a qualitative performance criterion established its success criterion “Achievable”.

Methods, Results and Conclusion

The ability of the eBirdRad digital avian radar to effectively remove ground clutter from the same scene viewed with the analog BirdRad avian radar has been demonstrated under the Image Comparison section of PA1.2 (Section 6.1.2.1).

6.2 SAMPLING PROTOCOL

6.2.1 Quantitative Performance Criteria

6.2.1.1 Monitors and Records Bird Tracks 24/7 [PB1.1]

Objective

We designed Performance Criterion PB1.1 to assess the capability of the digital avian radars evaluated by the IVAR project to continuously monitor bird activity for extended periods of time. We established as the metric for PB1.1 evidence that a radar at any of the IVAR study locations could generate continuous track records for one week or more.

Methods

We chose two radars at NASWI for the demonstration of Performance Criterion PB1.1: the AR1 (WIAR1), which has an array antenna, and the older eBirdRad (WIEBirdRad) unit with its dish antenna. These radar units are co-located at NASWI and have been operated continuously as a part of the CEAT avian radar performance assessment program and the IVAR validation studies since August 2007.

The CEAT project staff uses a TVW to generate one-hour track histories from the plots and tracks files produced by the DRPs at, in this case, NASWI. This process generates 24 files per day per radar; these files are then stored in the CEAT data archives. The track history files are generated in a JPEG (image) format to provide a visual summary of the history of target activity at that location for that one-hour period. Examples of track history files from the WIAR1 and WIEBirdRad radars at NASWI are presented in **Figure 6-45** and **Figure 6-46**, respectively.

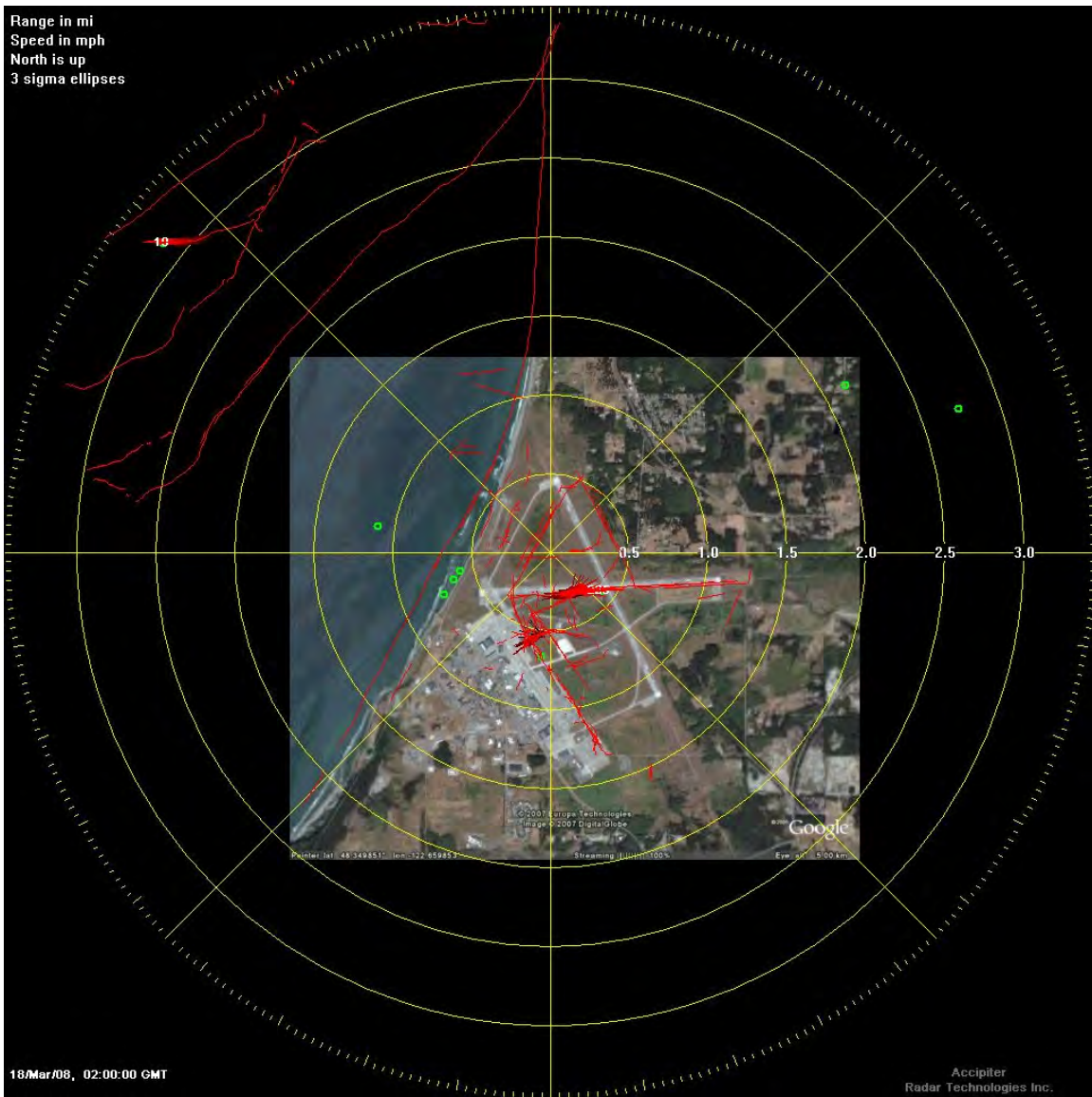

Figure 6-45. Image from track history file generated from the plots and tracks data of the WIAR1 radar, recorded on 18 March 2008 between 01:00-02:00 UTC. The fine red lines are the histories of tracked targets and the green circles are target detections that were not formed into tracks.

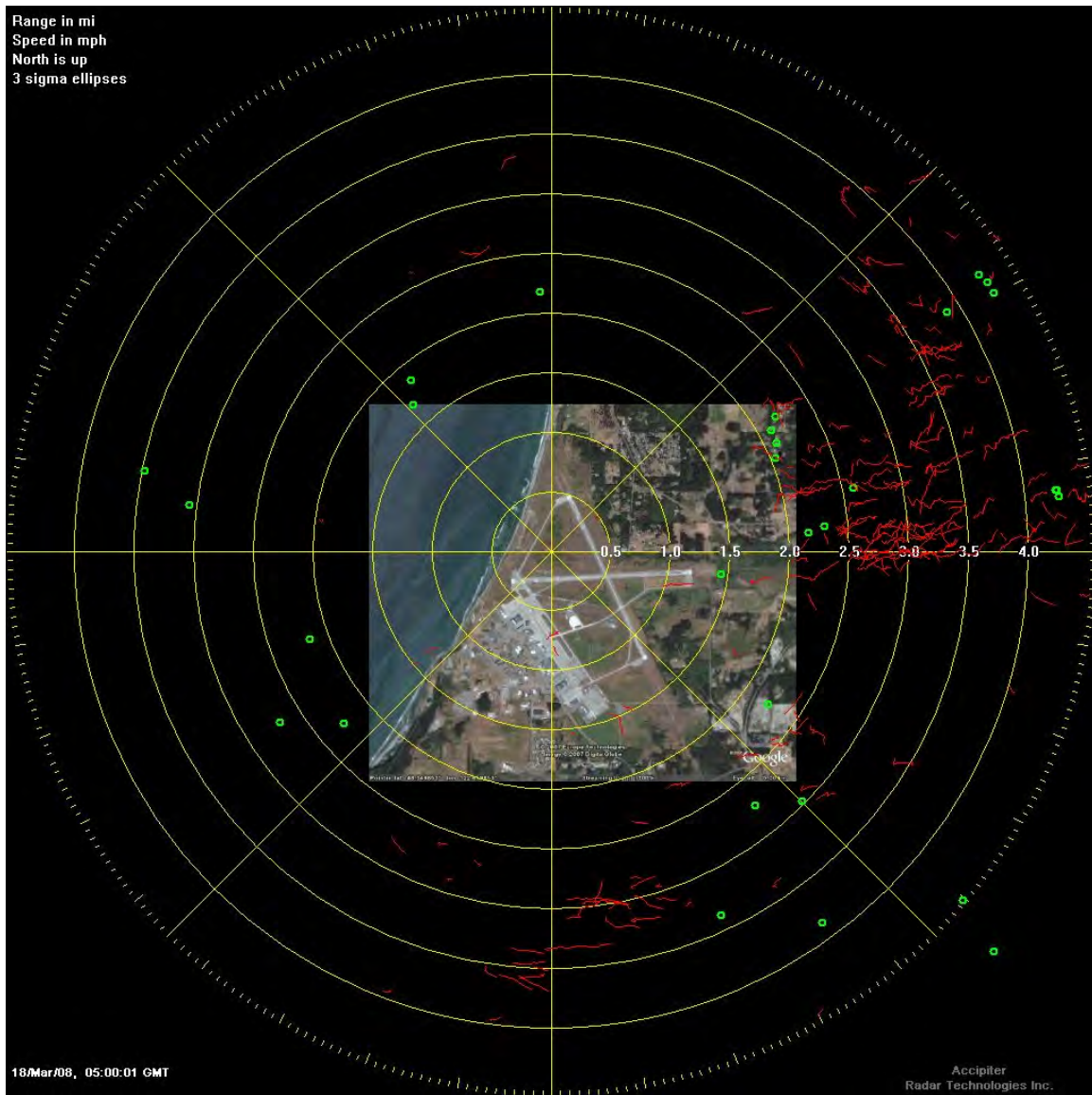

Figure 6-46. Image from the track history file generated from the plots and tracks data of the WIEBirdRad radar, recorded on 18 March 2008 between 12:00-13:00 UTC. The fine red lines are the histories of tracked targets; the green circles are target detections that were not formed into tracks.

To provide evidence of continuous operation, we selected a one-week period, 12 March 2008 through 18 March 2008, from the CEAT data archives for both the WIAR1 and the WIEBirdRad radars. We reviewed each history file to verify the presence of track histories, which demonstrates the radar’s operation.

Results

Appendix D lists the names of the 168 track history files from both the WIAR1 and WIEBirdRad radars at NASWI for the period 12 March 2008 through 18 March 2008. For brevity we have included only a list of the names of these 168 files (24 files/day X 7 days/week) for each radar.

The file names in the appendix encode the place and period summarized in the history file, in the following format¹⁹:

Location_Radar_Date_StartTime-EndTime.jpg

Thus the file name WI_AR1_20080312_0000-0100.jpg indicates:

Location = WI = NASWI

Radar = AR1= WIAR1

Date = 20080312 = 12 March 2008

StartTime = 0000 = 00:00 Pacific Standard Time (07:00 UTC)

EndTime = 0100 = 01:00 Pacific Standard Time (08:00 UTC)

Conclusions

We have successfully demonstrated Performance Criterion PB1.1 using both the AR1 and the eBirdRad radars. For the seven consecutive days from 12 March 2008 through 18 March 2008, the radars produced hourly track history files that summarize the continuous 24/7 operation of these radars. This capability is an important criterion for those applications where the radar must be used to sample for long periods to accumulate records of daily, seasonal, annual, and perhaps eventually decadal bird activity.

6.2.1.2 Samples Birds 360° in Field of View [PB2.1]

Objective

Our objective when designing Performance Criterion PB2.1 was to demonstrate that the digital avian radars can monitor bird activity in any direction from the radar transceiver location. Similar to the capability to track targets in three dimensions, sampling through 360° of azimuth is a critical functional requirement of avian radar systems. Birds can occur throughout a facility and they may approach critical areas (e.g., a runway or a wind farm) from almost any direction.

We chose as the metric for PB2.1 evidence that the plots and tracks data from a study location documented targets being tracked throughout a full, 360° field-of-view.

Methods

We elected to use the SEA AR-1 radar located at the midfield, the SEAAR1m, for the demonstration of Performance Criterion PB2.1. This radar has been in operation at SEA since July 2008 at this location.

To provide evidence of plot and track acquisition for a 360° field-of-view, we selected from the SEAAR1m radar data archives the four 15-minute track history files listed in **Table 6-14**. While one such file would have sufficed for this demonstration, we chose four files to illustrate coverage during different seasons of the year. We examined each of the track history files first to verify that targets were present in all four quadrants and then to determine if there was evidence of complicating factors such as precipitation during the sampling periods.

¹⁹ The actual file names on the CEAT server (e.g., those in **Table 6-14**) also encode the antenna type, beam width, and angle of elevation, the UTC date and time range, the file type, and the local day and time. We shortened these file names for brevity in the appendix, while still retaining the information to uniquely identify the corresponding files on the CEAT server.

Table 6-14. Dates, times and names of the track history files used to demonstrate 360° coverage by the SEAAR1m radar at SEA.

Date	Time (GMT)	Track History File Name
27 January 2009	01:55-02:10	SEA_AR1-A20-0DEG_20090127_0155-0210_JPG_26_1755-1810.jpg
05 April 2009	06:04-06:19	SEA_AR1-A20-0DEG_20090405_0604-0619_JPG_4_2314-2319.jpg
07 July 2009	12:30-12:45	SEA_AR1-A20-0DEG_20090707_1230-1245_JPG_7_0530-0545.jpg
08 October 2009	02:24-02:39	SEA_AR1-A20-0DEG_20091008_0224-0239_JPG_7_1924-1939.jpg

Results

The images from the four track history files listed above are presented in **Figure 6-47** through **Figure 6-51**. As is apparent from these images, tracks are visible through a 360° field-of-view on each of these dates.

The radars at SEA (and elsewhere) are typically configured to detect but not track targets whose speeds exceed a specified threshold (e.g., 40 m/s). This is done to avoid needlessly tracking aircraft at these busy air fields. Nonetheless, ground vehicles and taxiing aircraft often fall below this speed threshold and are tracked by the radar. Tracks that closely follow the runways and taxiways in the figures below are almost certainly ground vehicles or taxiing aircraft whose speeds fall within the speed threshold.

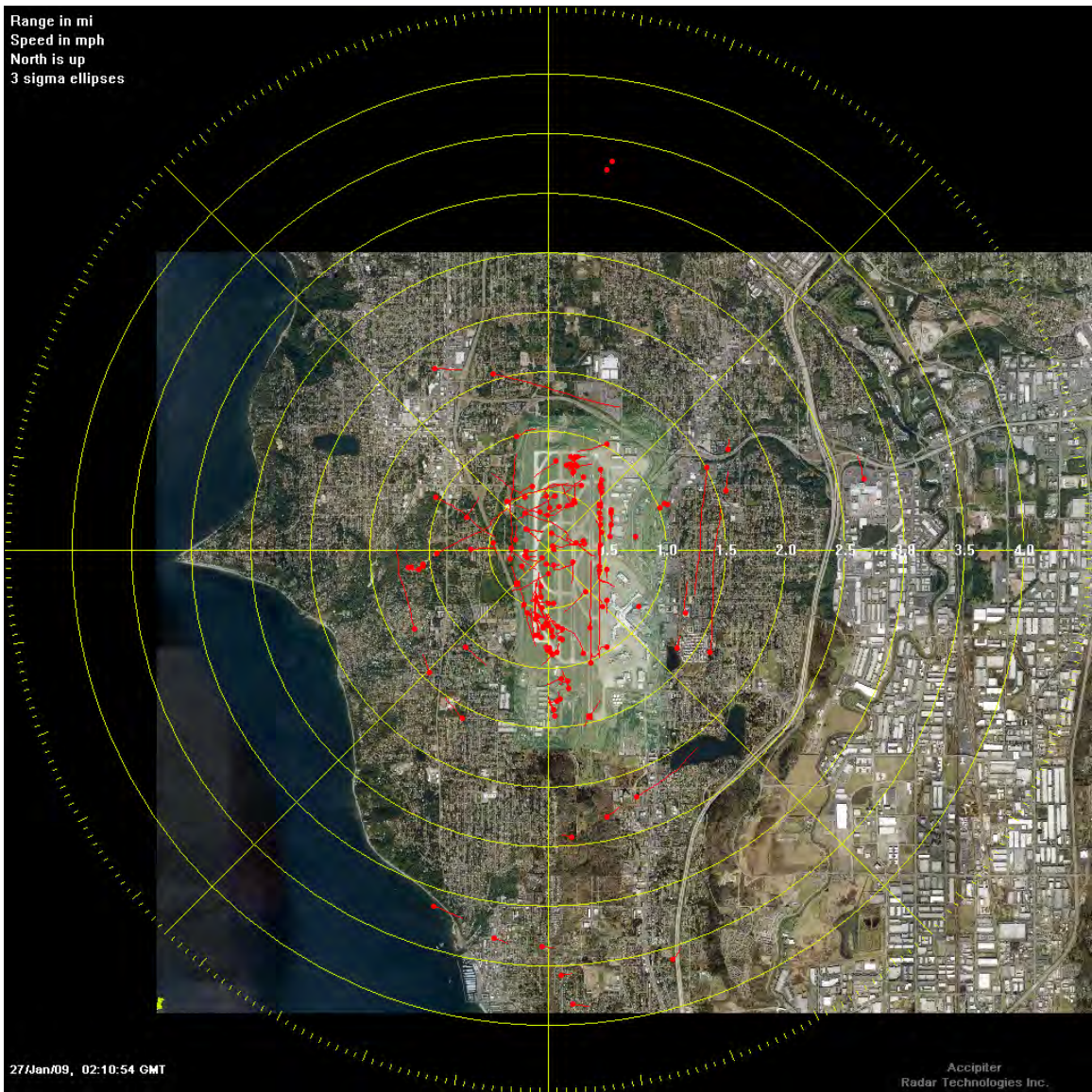

Figure 6-47. Fifteen-minute (01:55-02:10 GMT) track history for the SEAAR1m radar at SEA, 27 January 2009. The radar is located at the intersection of the eight (radial) coordinate lines.

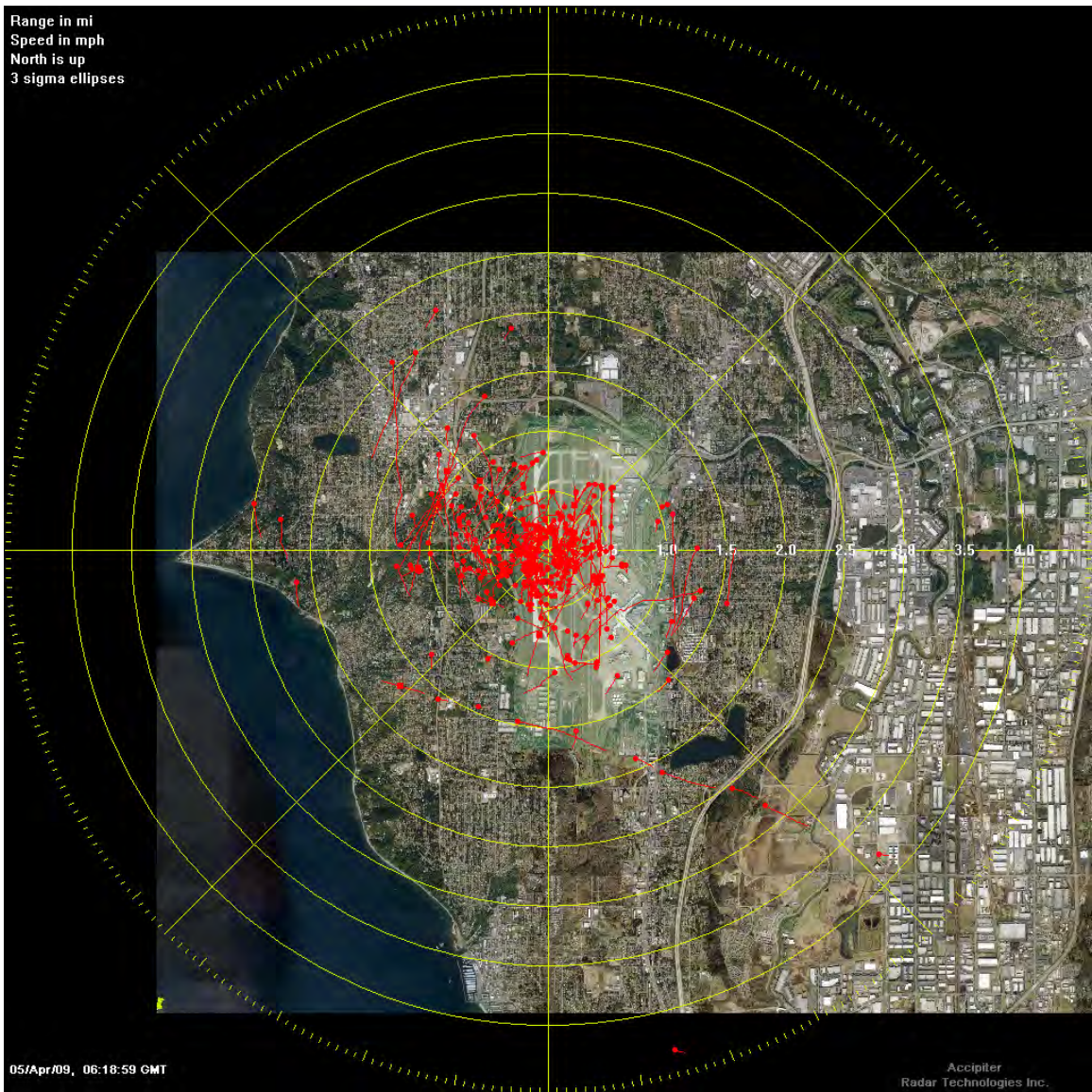

Figure 6-48. Fifteen-minute (06:04-06:19 GMT) track history for the SEAAR1m radar at SEA, 27 January 2009. The radar is located at the intersection of the eight (radial) coordinate lines.

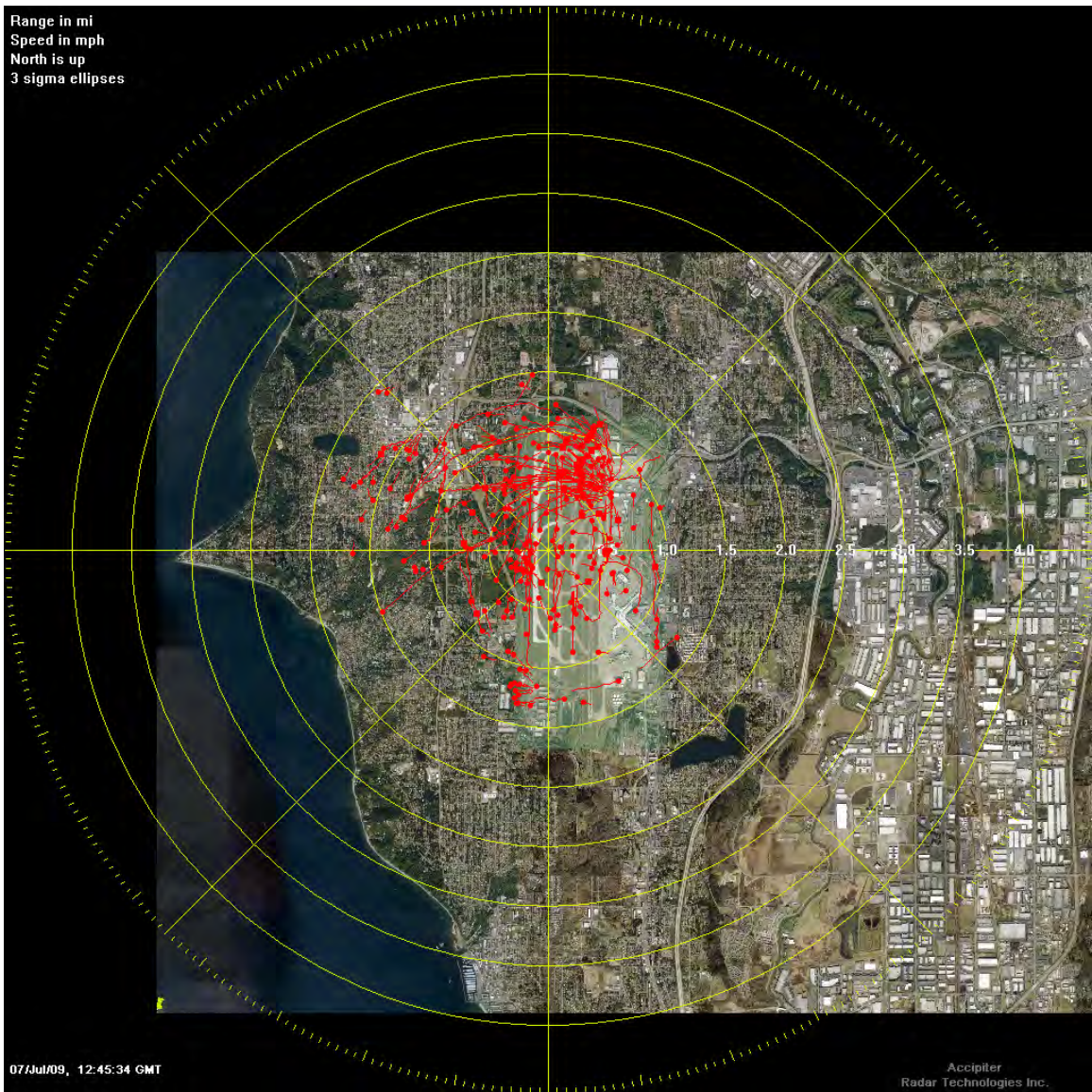

Figure 6-49. Fifteen-minute (12:30-12:45 GMT) track history for the SEAAR1m radar at SEA, 7 July 2009. The radar is located at the intersection of the eight (radial) coordinate lines.

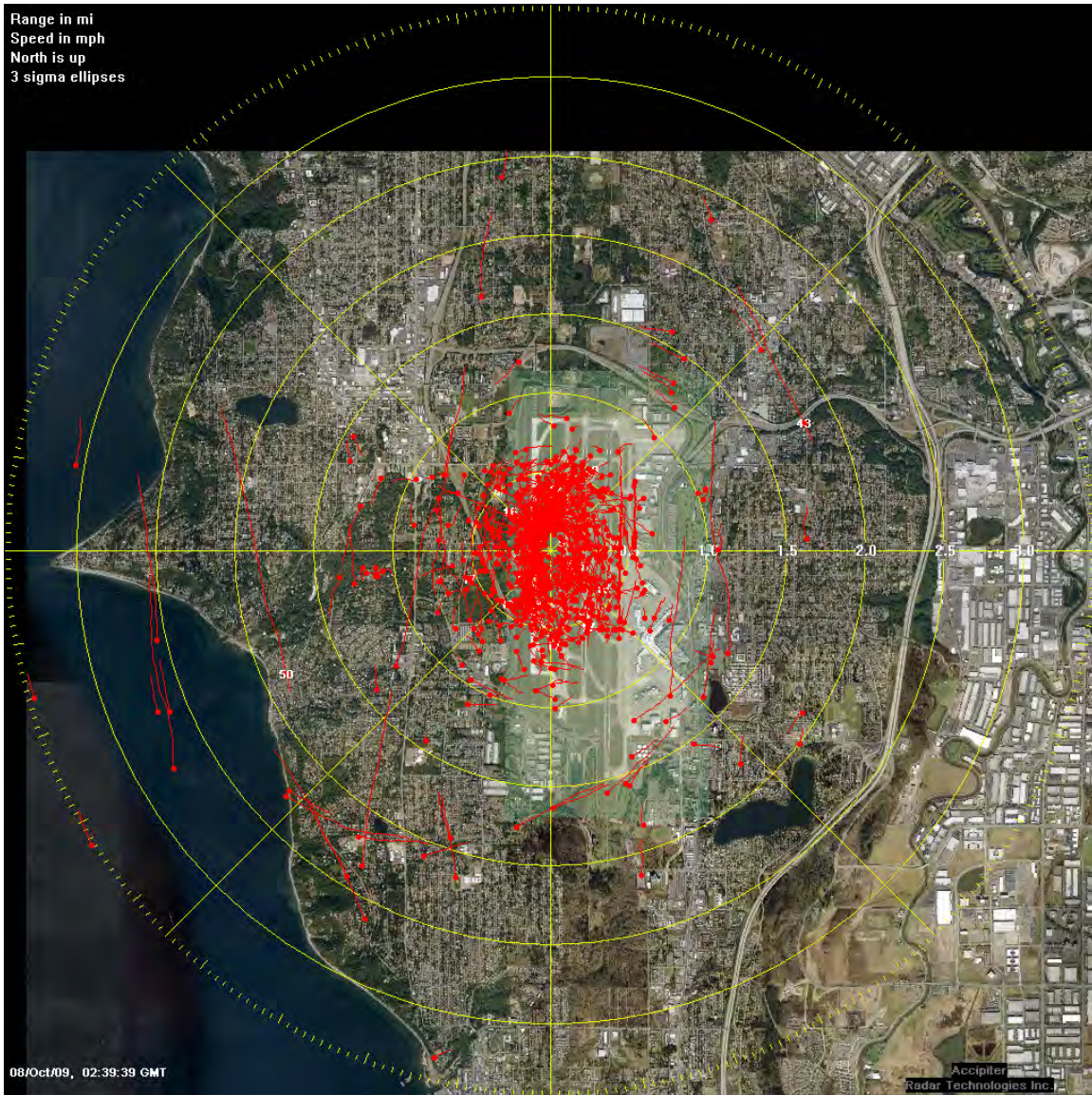

Figure 6-50. Fifteen-minute (02:24-02:39 GMT) track history for the SEAAR1m radar at SEA, 8 October 2009. The radar is located at the intersection of the eight (radial) coordinate lines.

Table 6-15 summarizes the number of targets tracked during 15 minutes in each of the four compass quadrants displayed in **Figure 6-47** through **Figure 6-50**. While the purpose of this demonstration is to confirm that the radars we are evaluating can sample targets through 360° of azimuth, and not to compare the spatial or temporal distribution of those targets, overall we found the total number of tracks in each quadrant for these selected dates to be fairly uniform.

Table 6-15. Number of targets tracked in the specified period of time from each of the compass quadrants around the SEAAR1m. Figure 6-47 through Figure 6-50 present the track history plots for these dates.

Quadrant	Number of Targets Tracked at Specified Date/Time (GMT)				Total Tracks
	01/27/09 01:55-02:10	04/05/09 06:14-06:19	07/07/09 12:30-12:45	10/08/09 02:24-02:39	
0-89°	39	87	102	175	403
90-179°	43	66	40	199	348
180-269°	36	116	52	207	411
270-359°	20	126	70	274	490

Conclusion

Performance Criterion PB2.1 has been successfully demonstrated: The four 15-minute track history files selected from over a one-year period clearly demonstrate the radar systems evaluated by the IVAR project are able to detect and track targets, including birds, through a full 360° field-of-view. This demonstration is another in the suite of capabilities these systems must have for use in long-term spatial and temporal sampling of bird populations, both for natural resources and bird-strike avoidance applications.

6.2.1.3 Samples out to 6 Nautical Miles [SB3.1]

Objective

As noted in Section 2.1, weather radars have been used to sample birds up to ranges of 110 km (60 nmi) and beyond, while airport surveillance radars have been used sample birds out to ranges of 55 km (30 nmi). One of the goals underlying the development of the original BirdRad radar was to provide better coverage between 0-11 km (0-6 nmi; Section 2.2). Performance Criteria PA1.1 (Section 6.1.1.1), PA4.1 (Section 6.1.1.4) and PA5.1 (Section 6.1.1.5) have demonstrated various aspects of detecting and tracking birds within the 0-11 km range. Our objective for Performance Criterion SB3.1 was to demonstrate that the avian radars the IVAR project is evaluating can detect and track targets, including birds, out to at least 11 km.

Methods

To demonstrate SB3.1, we chose to use data the CEAT project collected using the eBirdRad radar at Elmendorf AFB (EAFB) in Alaska on 15-16 May 2008. We chose those data because during that period the sampling range of the DRP was set to digitize out to a range of 15 km. The EAFB eBirdRad radar uses a 4° beam dish antenna.

At EAFB, and at the range of interest to us (11 km), the altitude band covered by the 4° antenna elevated to 5° above horizontal would have been 580-1355 m. This altitude is higher than most bird movements, except during nocturnal migration. However, there is an area southeast of the airfield at EAFB where the land rises up into the mountains. At a range of 11 km and within this area the land surface is approximately 500 m above the elevation of the radar, allowing the radar to sample airspace with daytime bird activity.

We used a TVW to process the plots and tracks data from EAFB, looking for birds in the southeast corridor at a range of 11.1 km or more. We distinguished birds from aircraft in the study area based on their speeds and flight behavior. Birds flew less than 25 m/s, light aircraft and helicopters flew 45 m/s or more, and jet aircraft flew 120 m/s and faster. Although the speeds of the tracks were determined using the TVW software, the relative speeds of targets are evident in the spacing between the updates (red squares) of tracks in the screen captures presented below: the faster the speed, the greater the distance the target will have traveled in the ~2.5 seconds between track updates.

Results

The eBirdRad radar At EAFB occasionally detected birds during the day at distances of 11 km or more southeast of the radar, where the topography rose towards the mountains. Track ID 677 in **Figure 6-52** is approximately 250 m AGL, an altitude at which one would expect to find the Common Raven, a species that is common in this area. Birds are not evident beyond 11 km elsewhere in **Figure 6-52** because the altitude of the beam pattern at those ranges was above the height at which most birds fly during the day.

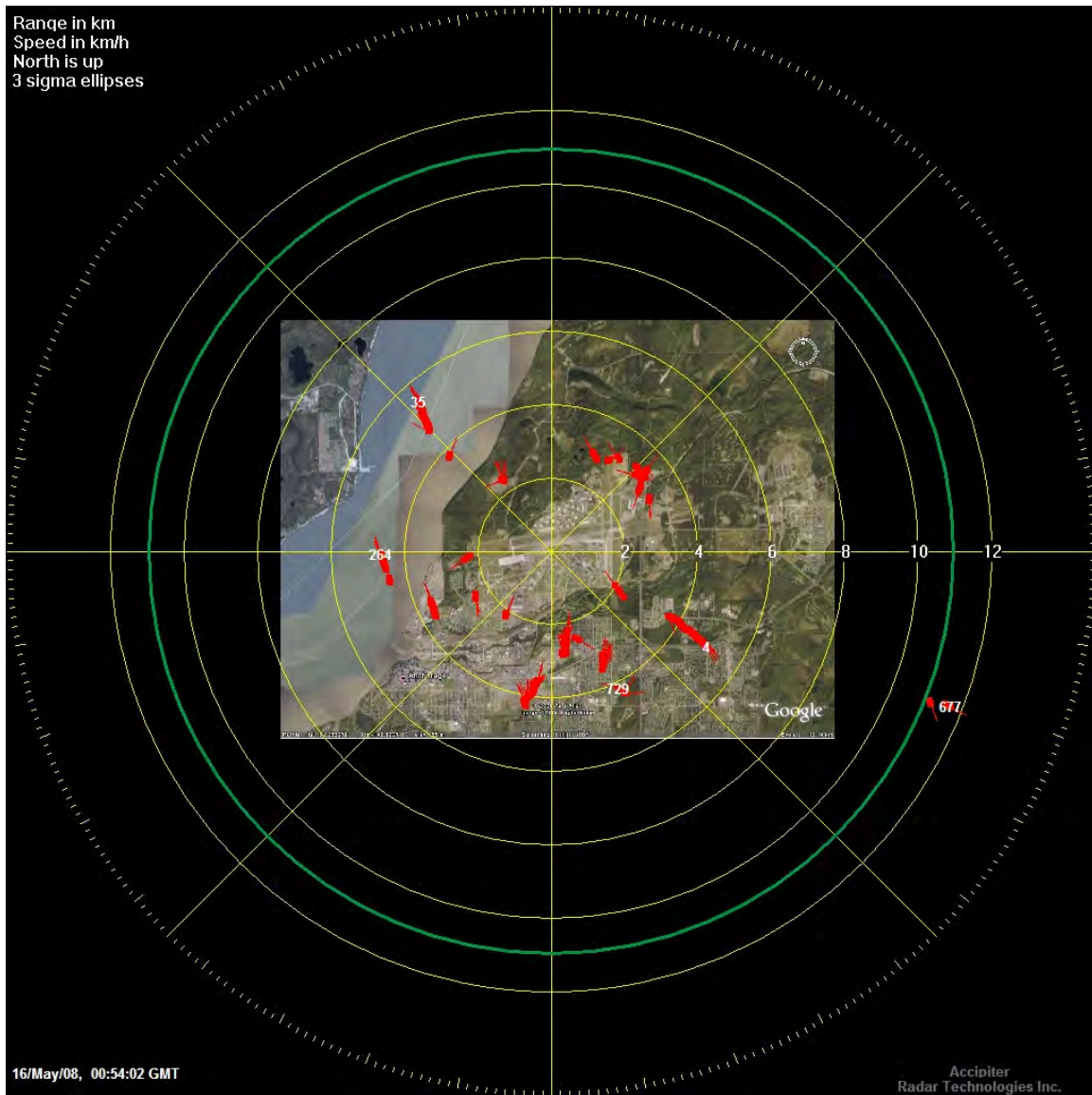

Figure 6-52. An example of birds (Track ID 677) detected during the daytime more than 6 nmi (11 km) southeast of the radar. The center of the radar beam is 760 m higher than the radar but the terrain is 500 m above the radar. Consequently, the birds are approximately 250 m above the terrain; an expected altitude for Common Ravens, a common species in the area. The green ring at 11 km indicates the criterion distance.

The eBirdRad radar detected some migrant birds out to and beyond the 11 km criterion (e.g., Track IDs 806 and 869 in **Figure 6-53**); there was, however, little migration during the days when these data were collected.

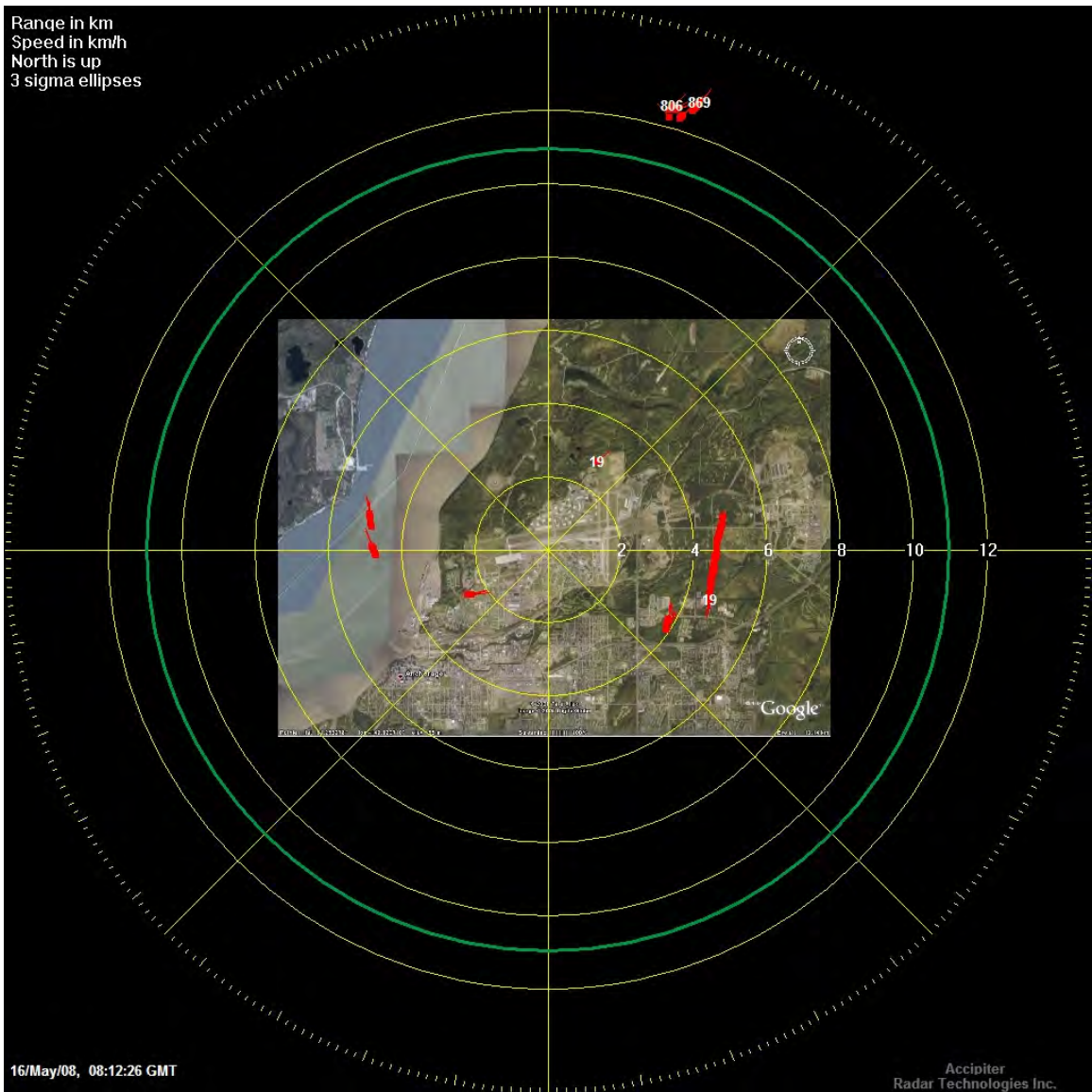

Figure 6-53. In an example of nighttime bird movement, Track IDs 806 and 869 more than 11 km north-northeast of the radar. These targets might have been nocturnal migrants such as shorebirds, which had begun arriving in the area three days prior. The green ring at 11 km indicates the criterion distance.

The radar easily tracked aircraft beyond 11 km (e.g., Track IDs 468 and 478 in Figure 6-54), unless the aircraft passed above or below the beam pattern.

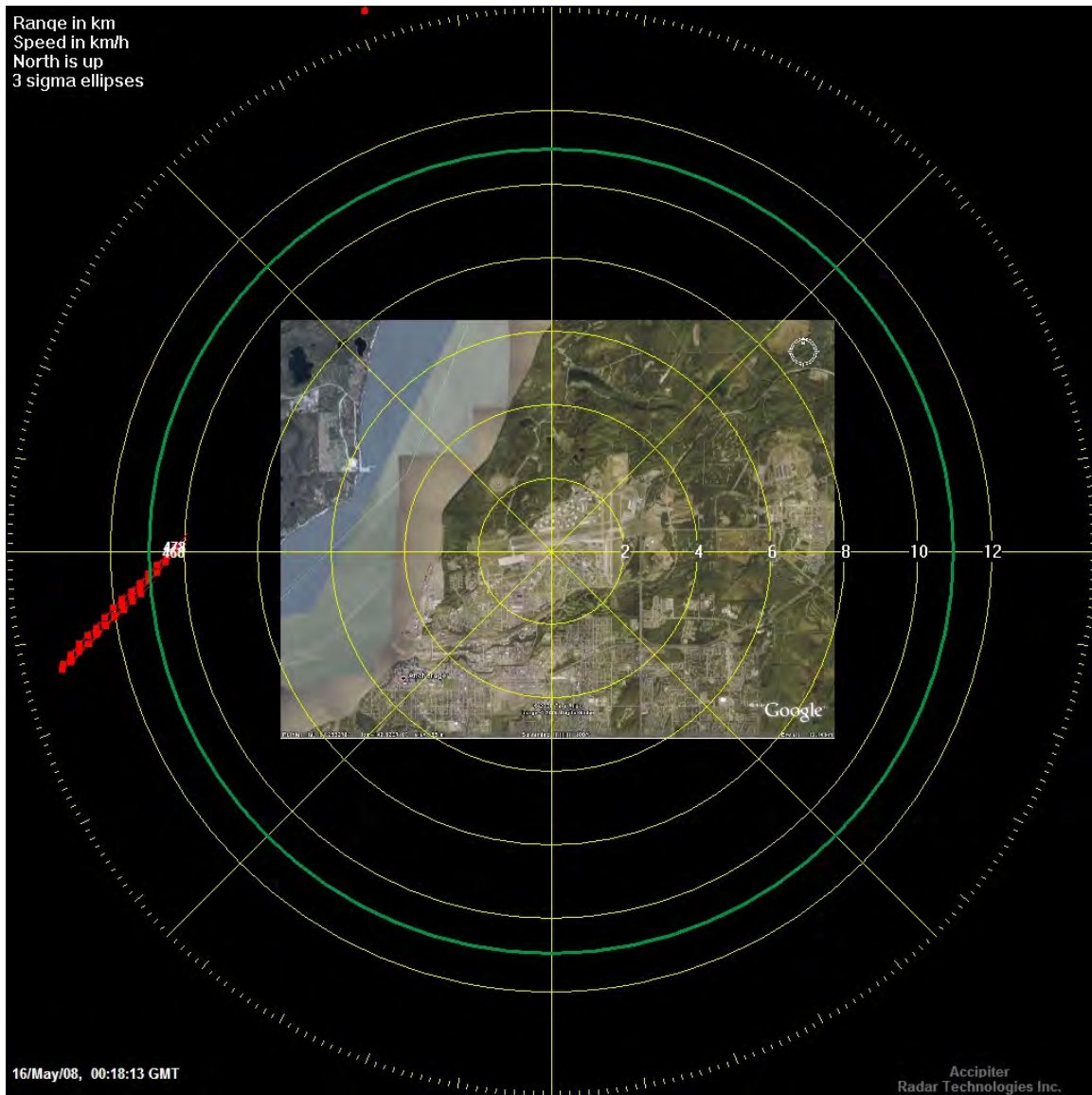

Figure 6-54. An example of an aircraft detected and tracked from beyond 11 km. The aircraft has two Track IDs (468 and 478) because it was a large aircraft (likely a Boeing 747) occupying multiple detection cells. Aircraft into and out of the Anchorage International Airport typically followed this same route. The green ring at 11 km indicates the criterion distance.

Conclusion

We have successfully demonstrated PB3.1, and conclude from this and the successful demonstration of other Performance Criteria (i.e., PA1.1, PA4.1, and PA5.1) that the avian radar systems evaluated by the IVAR project can detect birds in the desired near-range of 0-11 km.

6.2.1.4 Efficiently Stores Bird Track Information [PB4.1]

Objective

Our goal of Performance Criterion PB4.1, Efficiently Stores Bird Track Information, was to demonstrate that the avian radar systems being evaluated by the IVAR project can store the plots and tracks data they generate on conventional mass storage devices – such as the hard disks that are standard items from most personal computer manufacturers today.

Storing long-term records of bird activity locally at a facility is an important requirement for avian radar systems. These records will form the basis for a wide range of historical analysis of spatial and temporal activity patterns, both within and among facilities. The parameters stored in these records must be rich enough to support both operational applications as well as further research into the capabilities of avian radar systems, such target classification, data fusions, etc. However, these requirements and applications notwithstanding, the amount of data generated must not be so voluminous that it requires specialized, and therefore expensive, mass storage technology.

We set as our success criterion for PB4.1 that storing one or more year's worth of plots and tracks data locally would be both technically feasible and affordable.

Methods

We used long-term datasets from three IVAR locations – MCASCP, NASWI, and SEA – to estimate the storage required for one year's worth of data from the radar(s) at those locations. The radar systems at all three locations write their plots and tracks data to data files on a local hard drive; at the NASWI and SEA locations the local data files were also routinely transferred to a file server at CEAT for backup and analysis.

The estimate of data storage requirements we present below is empirical, based on actual data from operational radar systems. It was designed to bracket the range of data storage requirements a user is likely to encounter with a continuously-operating avian radar system. We have made no attempt to explain the differences in the storage requirements from one dataset another. Common factors that might contribute to such differences include:

- Number of targets
- Maximum digitization range
- Radar sensitivity settings
- Clutter (increases detections, or plots, that do not become tracks)
- Antenna beam width (sampling volume)
- Radar down-time
- Loss of network connectivity (for streamed data)

It should also be noted that we have estimated the storage requirements for the plots and tracks data extracted from the raw digital radar images, and not from the raw digital signals themselves. The storage requirements for the raw digital data are much higher – on the order of 350 Mb/minute of operation.

Results

Table 6-16 enumerates the amount of mass storage required to store the plots & tracks data files generated over a one-year period by the radars at the MCASCP, NASWI, and SEA study

locations. Each of these storage requirements is well within the range of inexpensive COTS hard drives available from retail computer and disk storage manufacturers. In fact, with 1 terabyte (Tb) internal and external hard drives selling for approximately \$100 in today’s retail market, one such drive could store up to five years of continuous plots and tracks data from these radars.

Table 6-16. Data storage requirements for plots and tracks data files generated by each of five radars operated continuously for one year at the specified locations.

Location	Radar (antenna type)	Dates of Operation	Data Storage (GB)
MCASCP	eBirdRad (dish)	01Oct07 – 30Sep08	190
NASWI	AR-1 (array)	01Oct07 – 30Sep08	95
	eBirdRad (dish)	01Oct07 – 30Sep08	40
SEA	SEAR2u (dish)	01Oct07 – 30Sep08	33
	SEAR2l (dish)	01Oct07 – 30Sep08	27

While we have demonstrated the technical feasibility and low cost of storing a year’s worth of radar data on local mass storage devices, from an operational standpoint copies of the data should be stored on a remote storage device (i.e., file server or database) for both data security and end-use applications.

Conclusion

We have successfully demonstrated that readily available and inexpensive COTS mass storage devices can store the amount of plots and tracks data generated over a one-year period of continuous operation by the avian radar systems being evaluated by the IVAR project. This capability will ensure the long-term storage of bird activity data for both operational and historical data analyses.

6.2.1.5 Increase in Number of Birds Sampled [PB5.1]

Objective

Performance Criterion PB5.1, Increase in The Number of Birds Sampled, is a primary criterion for demonstrating the Sampling Regime capabilities of avian radars. Our objective in this case was to demonstrate that the number of birds sampled by an avian radar far exceeds the number that would normally be obtained using conventional visual count methods.

To demonstrate this capability, the IVAR team established as its Success Criterion (**Table 3-1**) that the avian radar would detect and track at least 100% more birds than a conventional visual sampling method.

Methods

USDA/Wildlife Services personnel collected conventional visual census data at MCAS Cherry Point over a one-year period, from 01 October 2007 through 30 September 2008. They established twenty-four Point-Count sites and divided them into two groups of 12 each for the two count blocks: **Figure 6-55** indicates the positions of sites 1-12 in the first count block;

Figure 6-56 shows sites 13-24 in the second count block. Weekly samplings alternated between the two count blocks throughout the 1-year period.

Each point count site denoted the center of a 400 m (0.25 mile) radius circle. We collected data using standardized Point-Count methods (count and record the behavior of all birds seen and heard for 5 minutes within the Point-Count circle). For the purpose of this comparison, we used only birds recorded as "flying past" or "all flying". "Flying past" is defined as when a bird did not take off or land within the count circle. "All flying" included the birds that were recorded as "flying past" as well as flying birds that took off from or landed within the count circle during the time of the Point-Count. We excluded from this analysis all birds seen perched or standing, or heard calling or singing.

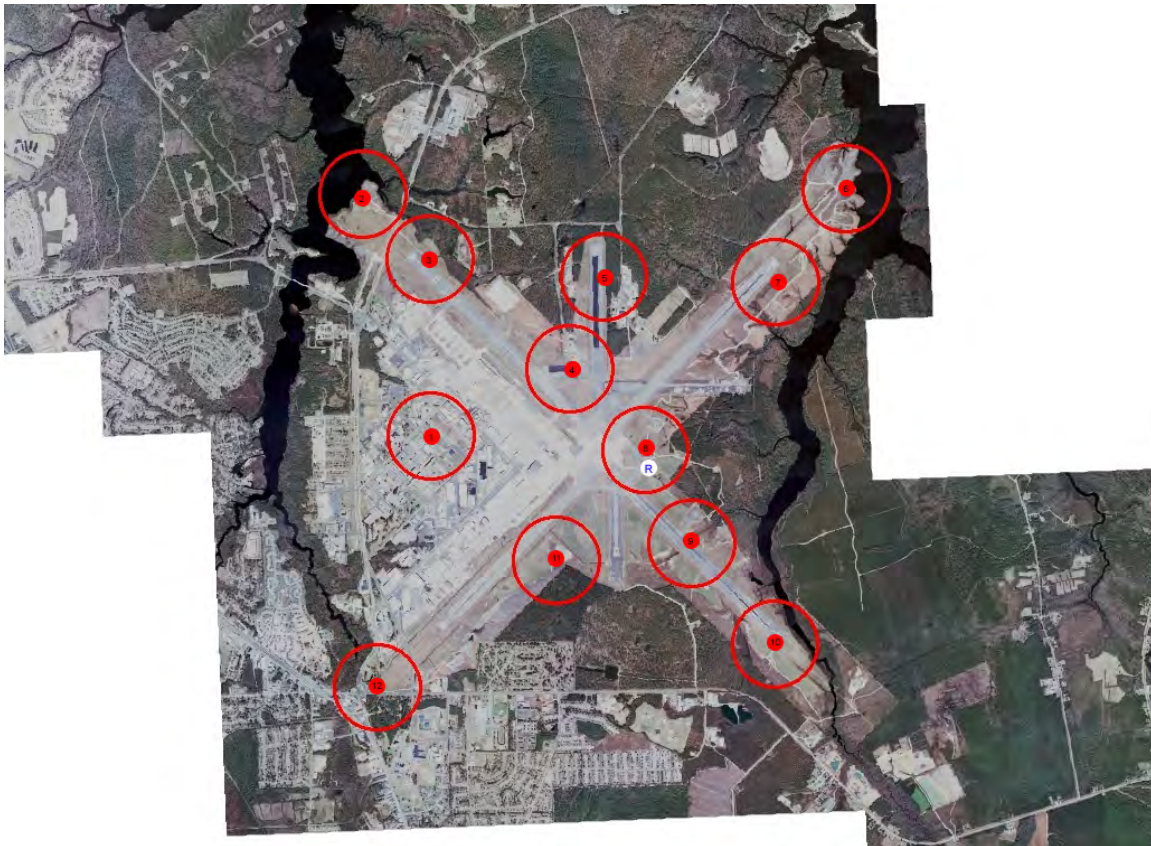

Figure 6-55. Location of point-count sampling sites 1-12 at MCAS, Cherry Point. "R" indicates site of the eBirdRad avian radar.

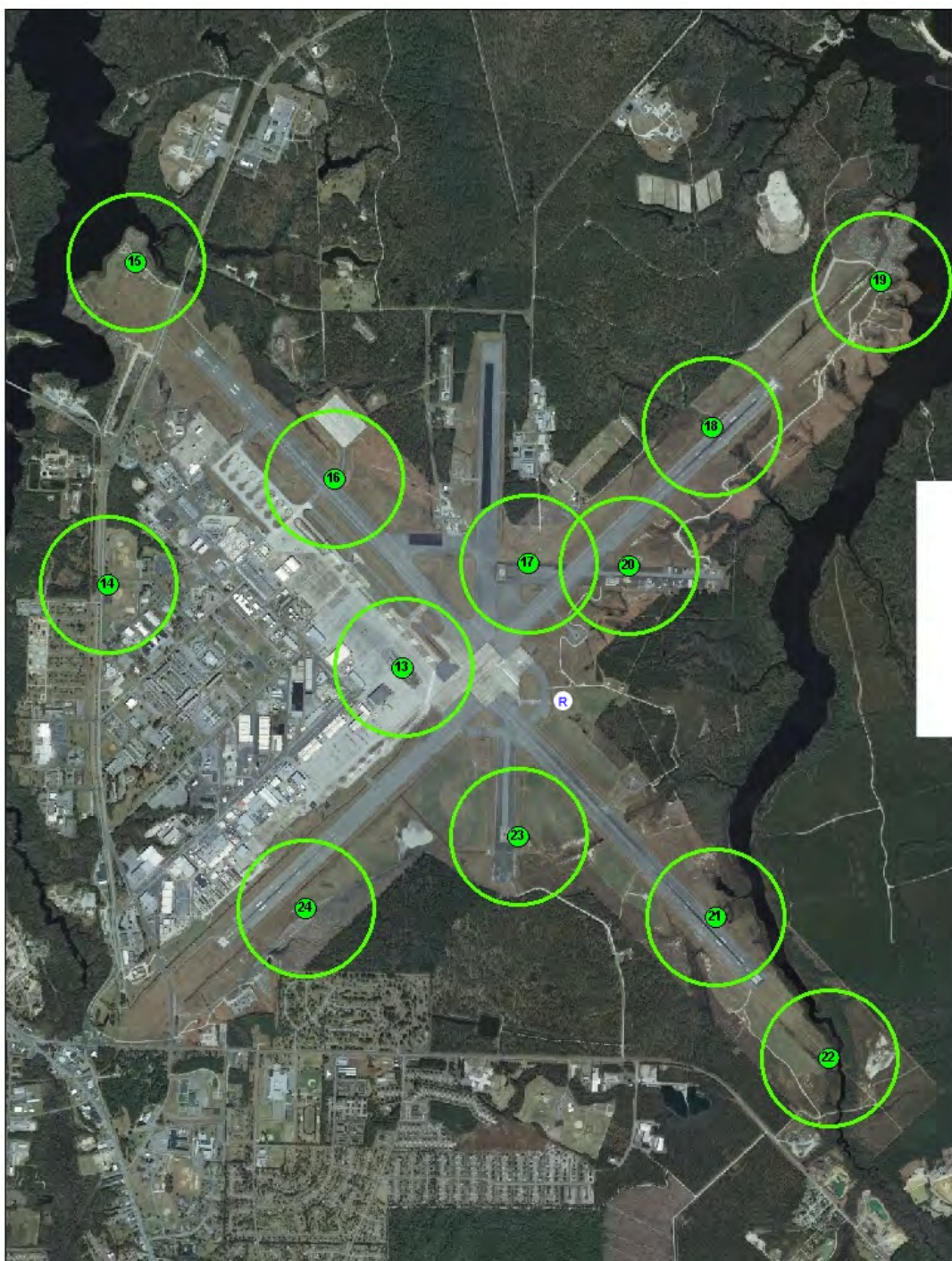

Figure 6-56. Location of point-count sampling sites 13-24 at MCAS, Cherry Point. “R” denotes site of the eBirdRad avian radar.

The eBirdRad avian radar is located near the center of the airfield (**Figure 6-55**) and was operated 24/7 throughout this 1-year period, recording plots and tracks data on a local hard drive.

We extracted the radar data for this analysis from the plots and tracks files by constructing alarm regions in the TrackViewer software and playing back the recorded data that corresponded to the times of the Point-Counts. We labeled the alarm zones with the number corresponding to the visual sampling Point-Count Circle to allow a comparison between visual counts and radar counts for individual Point-Count Circles. The data were analyzed for times that corresponded to the time the visual observer was at each Point-Count site and for all 12 Point-Count sites for the time of the complete count block. Thus, there are two comparisons made: A 5-minute synchronized comparison between visual observations and the radar, and a comparison for the total (1-2 hours) period of the visual survey block between visual and radar.

Results

The mean numbers of birds seen on the synchronized comparison did not differ between the two techniques: Visual = 1.78 birds/point count, Radar = 2.0 birds/point count; Student's $t = -0.1127$, $df = 44$, $P > 0.05$.

Our comparison of the total number of birds detected per hour for the 12 sites for the total count block demonstrated that the radar detected significantly more birds (mean = 97.3 birds/hour) than the visual observer (mean flying past = 2.14 birds/hour; mean all flying = 7.06 birds/hour) (ANOVA: $F_{2,51} = 37.4$, $P < 0.01$).

There is an obvious inequality in comparing the number of birds observed for the duration of the visual count block: An observer is at each of the 12 sites for 5 minutes but the radar is monitoring all 12 sites during the same period of time. If the number of birds detected by the radar is adjusted to a detection rate per 5 minutes (mean = 8.12) and compared to the visual count (mean = 2.14; flying past), the radar still detected significantly more birds than the visual observer (Student's $t = -4.61$, $df = 17$, $P < 0.001$).

The above comparison is not inconsistent with the results of the synchronized comparison. The synchronized comparison included only point-count observations in which the visual observer recorded birds "flying past." The above comparison includes all Point-Count observations for that block including the ones in which the visual observer did not record any birds as "flying past" but the radar detected birds flying within the count circle.

Conclusion

The radar detects about 4-times as many birds as a visual observer for 5-minute synchronized Point-Count observation periods. For an entire count block (1 hour of observation), the radar detected about 50-times as many birds as a visual observer because the radar could monitor all 12 point-count sites simultaneously while the visual observer could monitor only one. Thus, the Success Criterion for PB5.1 was exceeded in both the synchronized and the total time period comparisons.

6.2.1.6 SAMPLES UP TO 3000 FEET [SB6.1]

Objective

More than 90% of all bird strikes occur below 914 m (3000 feet) above ground level (Dolbeer, 2006). Performance Criterion SB6.1, Samples to 3000 Feet, is a secondary criterion designed to demonstrate that avian radar is capable of sampling birds at the upper end of this range. We chose 914 m (3000 ft) as the performance metric for a successful demonstration of this capability

of the avian radar system. This altitude is also in the range of altitudes at which some migrating birds are known to fly.

Methods

Figure 6-57 is a digital image of the display of the eBirdRad avian radar at Edisto Island, South Carolina on 5 October 2008 at 00:43:37 GMT²⁰. In the display, the symbols are the same as previous examples: the green circles are detections that have not been formed into tracks, while the red squares with a red line (heading of target) and white numerals (Track ID) indicate the current position of a target that is being tracked by the radar.

This particular eBirdRad unit was equipped with a dish antenna that had a 2.5° beam width and was set to an angle of 30° above the horizontal. At a 30° angle of inclination, the altitude of a target is half of its range. Thus, any target at a range >2 km from the radar would be at an altitude >1 km (3280 ft), and would therefore meet the performance metric for this demonstration.

²⁰ 4 October 2008 at 20:43:37 Eastern Daylight Time

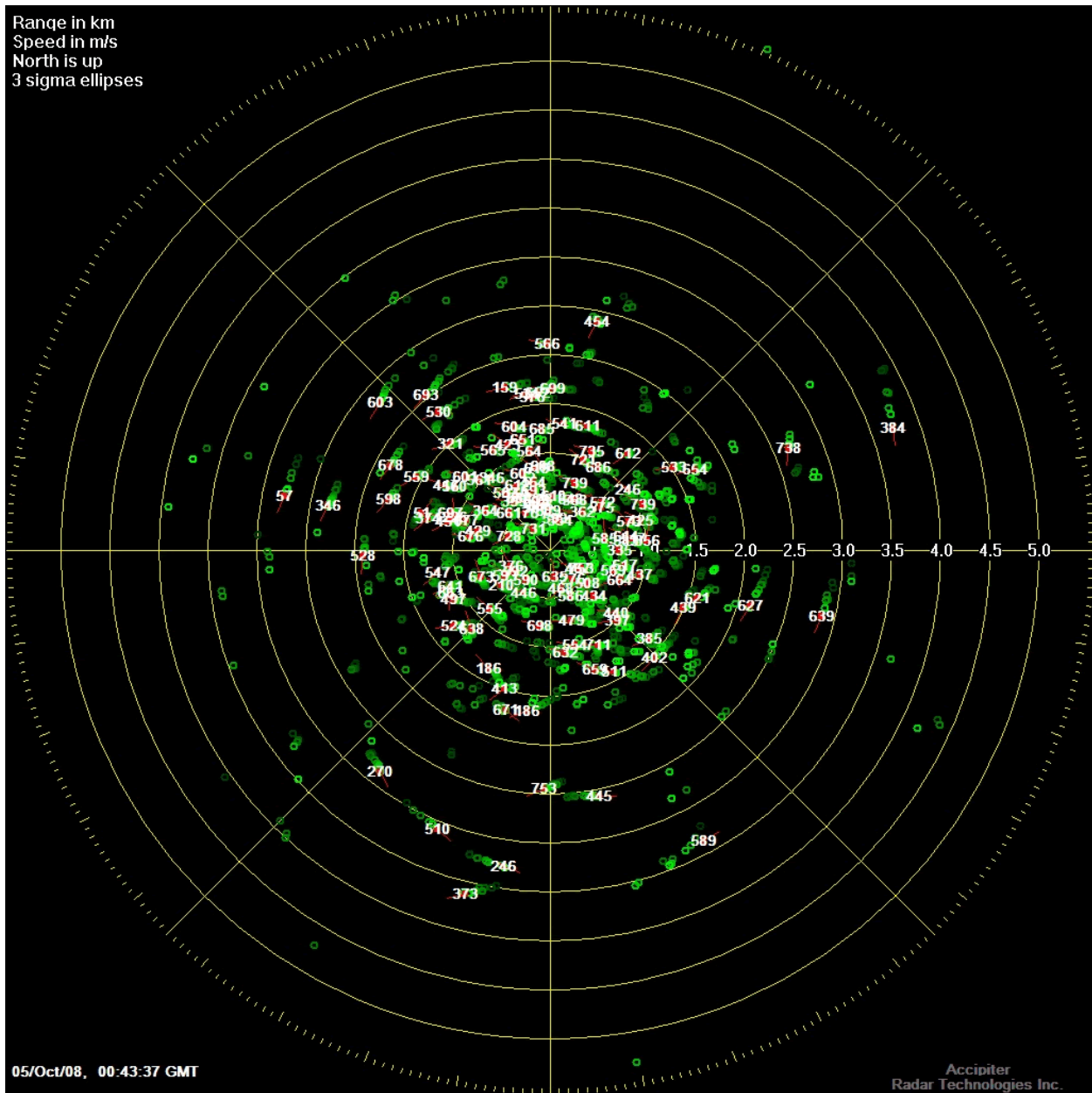

Figure 6-57. Digital image of the display of the eBirdRad radar at Edisto Island, South Carolina on 5 October 2008 GMT. The radar was equipped with a dish antenna that had a 2.5° beam width and was inclined 30° above horizontal. The range rings in the display are in kilometers. The green circles are detections; the red squares with white numbers (Track ID) indicate the current position of a tracked target.

Results

There are 17 bird targets in **Figure 6-57** that are beyond the 2 km range ring, and thus more than 1000 m (3280 ft) AGL. **Table 6-17** presents the altitudinal distribution, in meters, of these 17 targets at the start of the track, as well as their calculated mean altitude over the duration of each

track. The “Altitude” values in **Table 6-17** were generated by the DRP software, which uses the bore-sight of the antenna in its calculations. However, the antenna beam pattern is 2.5° in diameter and it is not possible to determine where within the beam the target is actually located. Thus, we also computed the Upper Edge and the Lower Edge of the radar beam based on the beam width (2.5°) and inclination angle of the antenna (30°). This was done to confirm that the birds used to demonstrate this criterion were above an altitude of 914 m (3000') throughout the course of their track. Because not all of the birds were detected at the beginning of their tracks, we also computed the mean altitude values for each track.

It should also be noted that, as is evident in **Figure 6-57** and **Table 6-17**, these 17 targets flying above 1000 m were also distributed throughout all four quadrants of azimuth around the radar (see also Section 6.2.1.2).

Conclusion

The values recorded by the DRP and presented in **Table 6-17** successfully demonstrate that the eBirdRad system is capable of detecting and tracking birds within the range of altitudes at which most bird strikes occurs and at which some migratory species fly.

Table 6-17. Altitudinal distribution of targets shown in Figure 6-57. Date and time are reported as GMT, all distance measurements are in meters, and all altitudes are above ground level (AGL). Range and Altitude values are from the radar to the target. All values are extracted from the DRP database, except the lower and upper edges of the beam, which are calculated based on the 2.5° beam diameter and the 30° antenna elevation angle.

				Start of Track					Mean of Track				
							Edge of Radar Beam					Edge of beam	
Date	Track ID	Start time	Number updates	Range m	Azimuth °	Altitude m	Bottom m	Top m	Range m	Azimuth °	Altitude m	Lower m	Upper m
10/5/2008	57	0:42:57	16	2744	296	1372	1320	1424	2758	289	1379	1327	1431
10/5/2008	246	0:42:26	38	3168	207	1584	1524	1644	3291	194	1646	1583	1707
10/5/2008	270	0:43:06	25	2734	222	1367	1315	1418	2864	217	1432	1378	1486
10/5/2008	346	0:41:35	53	2164	306	1082	1041	1123	2268	290	1134	1091	1177
10/5/2008	373	0:43:15	15	3488	190	1744	1678	1810	3594	194	1797	1729	1865
10/5/2008	384	0:43:12	10	3875	61	1938	1864	2010	3791	65	1896	1823	1967
10/5/2008	445	0:43:18	24	2514	175	1257	1209	1304	2608	168	1304	1254	1353
10/5/2008	454	0:43:32	8	2405	11	1202	1157	1248	2366	11	1183	1138	1227
10/5/2008	510	0:42:55	18	2926	216	1463	1407	1518	3013	208	1507	1449	1563
10/5/2008	566	0:43:32	4	2079	4	1040	1000	1079	2100	1	1050	1010	1089
10/5/2008	589	0:43:32	3	3350	155	1675	1611	1738	3347	153	1674	1610	1736
10/5/2008	603	0:43:30	19	2332	313	1166	1122	1210	2276	305	1138	1095	1181
10/5/2008	627	0:42:49	20	2355	89	1177	1133	1222	2224	99	1112	1070	1154
10/5/2008	639	0:42:52	17	2960	91	1480	1424	1536	2902	97	1451	1396	1506
10/5/2008	693	0:43:07	14	2169	334	1084	1043	1125	2090	324	1045	1005	1084
10/5/2008	738	0:43:38	6	2646	67	1323	1273	1373	2590	68	1295	1246	1344
10/5/2008	753	0:43:00	21	2440	175	1165	1174	1266	2416	180	1208	1162	1253

6.2.2 Qualitative Performance Criteria

6.2.2.1 Sampling of Diurnal and Seasonal Bird Activity Patterns [PB1.2]

Objective

Many potential applications for avian radar systems will involve comparing bird abundance and activity patterns over time: day vs. night, daily (diurnal), seasonal, annual, and inter-annual. For this reason, we designed PB1.2 to demonstrate the capacity to sample at intermediate time-scales – diurnal and seasonal – using the avian radar systems the IVAR project is evaluating.

Methods

Our original plan for demonstrating PB1.2 was to provide a listing of the plots and tracks data file names that had been generated for a 24-hour period (diurnal sampling) every three months (seasonal sampling) for one year at the same study location. However, in preparing the demonstrations for several other Performance Criteria (see Table 6-18) we realized those demonstrations provided much more detailed information about the diurnal and seasonal sampling capabilities of these radars.

Table 6-18. Performance criteria that provided information to support the demonstration that avian radar systems can sample diurnal and seasonal bird activity patterns. “Section/Page” refers to the location of that Criterion in this document.

Performance Criterion (Section/Page)	Demonstration Of:	
	Diurnal Sampling	Seasonal Sampling
PB1.1 (6.2.1.1/137)	√	
PB2.1 (6.2.1.2/140)		√
PB4.1 (6.2.1.4/151)	√	√
PB4.2 (6.2.2.4/175)	√	
PB5.1 (6.2.1.5/152)		√
PB5.2 (6.2.2.5 180)	√	
PB7.2 (6.2.2.7/186)	√	√
PB9.2 (6.2.2.9/194)	√	

For this reason, the Results section below provides summaries of and references to those sections of the Performance Criteria that present evidence that the avian radar systems we evaluated can supply bird track data in support of diurnal and seasonal sampling studies.

Results

Daily Activity

Most bird species exhibit differences in their diurnal, or daily, activity patterns. Some feed during the day, others at night; some migrate at night, others during the day. To demonstrate PB1.1 (Section 6.2.1.1/page 137), we generated 24 1-hour track history plots of bird activity for an entire day. We also provided two examples of the plots from NASWI that, while only three

hours apart, showed considerable variation in the amount and spatial distribution of bird activity. In Appendix D we listed names of the 168 1-hour track history files generated for NASWI for the one-week study period during March 2008.

We expanded upon the same methodology in our demonstration of PB4.2, Provides spatial distributions of birds over periods of time (Section 6.2.2.4/page 175). There we generated 12 2-hour track history plots for the SEAAR11 avian radar at SEA. Again, these plots showed considerable variability in both the spatial and temporal distribution of bird activity over a one-day period. PB5.2 (Section 6.2.2.5/page 180) used the same data but generated a 24-hour track history to show daily bird activity overlain on a map.

We designed Performance Criterion PB7.2 to demonstrate the radars' ability to record track abundance data over long periods of time – in this case, an entire year. Table 6-21 (page 172) presents the abundance figures for three 1-hour periods on the same day, Figure 6-78 (page 189) plots the daily abundance figures for an entire year, and Figure 6-80 (page 192) through Figure 6-82 (page 193) provide hourly counts for a 5-day period. Collectively, these figures provide measures of hourly, daily and seasonal variations in target traffic at SEA.

While many of these Performance Criteria demonstrated 24-hour, day and night sampling, in PB9.2 (Section 6.2.2.9/page 194) we specifically emphasized the ability of these avian radars to sample at night, a time when many other sampling methods are ineffective.

Finally, in PB4.1 (Section 6.2.1.4/page 151) we demonstrated that these avian radar systems could efficiently store the plots and tracks generated over a 1-year period of continuous sampling.

Still other Performance Criteria touched indirectly on the ability of these radar systems to sample on a daily basis: PC3.1 (Section 6.3.1.2/page 201) and PC4.1 (Section 6.3.1.3/page 203) used 24 hours of track data to demonstrate wired LAN availability and streaming data into a database, respectively.

Seasonal Activity

Some of the user requirements underlying the development of the eBirdRad avian radar system (see Section 1.2) presumed the systems would be programmed to sample at certain times of the day, month or year, and then would be in standby mode the rest of the time (see Sections 6.2.2.2 & 6.2.2.3 for demonstrations of these capabilities). As it has turned out, most of these radars are being operated and recording data continuously. Thus, the difference between diurnal and seasonal sampling is primarily a function of the time-scale over which the analyst is looking at the data records.

For example, in PB2.1 (Section 6.2.1.2/page 140) we chose to demonstrate the ability of these radars to sample through a 360° field-of-view by using four 15-minute track histories from SEA collected three months apart in the same year. The effect was seasonal sampling, which showed that at different times of the year, when the abundance and distribution of birds might be expected to differ, the radars could track birds in all directions.

Likewise, we designed PB5.1 (Section 6.2.1.5/page 152) to demonstrate that avian radars sample more birds than conventional sampling methods. To do so, we conducted weekly point-counts sampling for a year at two sets of 12 sites each at MCASCP. We then compared these counts to those we extracted from the continuous radar records for the same sites and times. Again, we

produced *de facto* seasonal sampling from an effort designed to demonstrate a different capability of these avian radar systems.

Finally, in PB7.2 (Section 6.2.2.7/page186) we chose a 1-year period of data from SEA to demonstrate the radars' ability to capture abundance data "over a long period of time." This produced a record of both daily (see above) and seasonal bird activity for that location.

Conclusion

Using the results from eight other Performance Criteria, we have successfully demonstrated that the avian radar systems the IVAR project evaluated can sample bird activity on both daily and seasonal time-scales. In these cases the time intervals of interest were extracted from more-or-less continuous data records for those locations. This further demonstrates that the end-users of these systems will be able to extract and analyze bird track data on time scales ranging from real time (2.5 seconds) up to duration of the radar records for that location.

6.2.2.2 Scheduled, Unattended Sampling Events [PB2.2]

Objective

"Automatic tracking" implies not only that the radar can detect and track targets automatically, but also that the radar can operate automatically according to a specified schedule. We designed Performance Criterion PB2.2, Scheduled, Unattended, Sampling Events, to demonstrate the system capability of being programmed in advance to power-on the radar, record plots and tracks data, and power-down the radar without human intervention.

We have recognized the importance of autonomy in remotely-deployed systems that are not easily reached by system operators. We also understand the logistics involved in visiting multiple radar nodes over a wide area network to manually start and stop radar processing for periodic sampling events. For these reasons, the IVAR team wanted to demonstrate that the avian radar systems they are evaluating can automate the sampling procedure, employing a user interface that enables a remote user to schedule sampling events for multiple radars.

The Accipiter® Auto-Scheduler is a browser-based scheduling application with a calendar interface. It gives system users the ability to view and edit the operational sc

This demonstration will be successful ("Achieved") if the radar hardware is powered on, it records plots and tracks, and the radar hardware is powered down over a predetermined time interval, all without human intervention.

Methods

A test network was established at ARTI in which a radar was connected to a DRP and a Remote Radar Controller (RRC). Appropriate access from a WAN (the Internet) to the test network was enabled through port-forwarding to provide the Auto-Scheduler with the required connectivity to each of the system components.

The sampling event was scheduled as follows:

- The radar was powered off.
- The DRP and RRC were left on, in idle states.
- The Auto-Scheduler application was run from a remote workstation (outside of ARTI).

- The sampling event time period was scheduled for Friday December 11, 2009 from 15:20 to 15:30 EST.
- System operational details were defined in the Auto-Scheduler: The radar was set to transmit in medium pulse and DRP Live was set to process the radar data and archive files locally.
- The event schedule was saved.

The Auto-Scheduler calendar interface is illustrated in Figure 6-58:

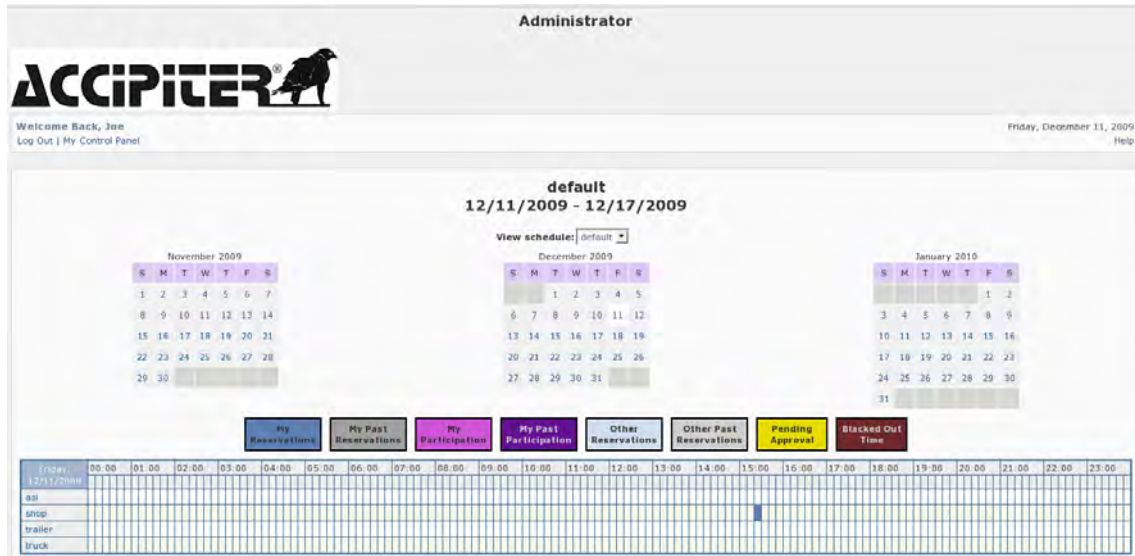

Figure 6-58. Auto-Scheduler main calendar interface.

After selecting the desired date and time period from the Auto-Scheduler calendar interface, we were prompted to fill in and confirm the event details in the reservation entry window. The sampling event details for the test demonstration can be seen in Figure 6-59.

shop

Basic Participants Accessories

Location	Accipiter Ltd., Fonthill, ON
Phone	
Notes	test site

Reminder: -- Never --
before reservation

Please change the starting and ending times:

Start	End
12/11/2009 <input type="text"/>	12/11/2009 <input type="text"/>
15:20 <input type="text"/>	15:30 <input type="text"/>

Will be reserved for:

Name	Joe Administrator Change
Phone	(905) 892-1875
Email	admin@sicomsystems.com

Created	12/11/2009 @ 11:48:26
Last Modified	12/11/2009 @ 15:13:58

Summary

medium file

Delete?

Figure 6-59. Auto-Scheduler reservation entry window.

The keywords “medium” and “file” were input in the summary field to indicate the desired operational mode of the radar and DRP Live (i.e., medium pulse, and save plots/tracks files). The “Save” button was then selected, which scheduled the event to occur at the specified time period.

We observed the sampling event at the scheduled time and took screen captures of the RRC web interface and the DRP desktop during the automated process. The Auto-Scheduler generated a log file as commands were issued to each of the system components. We acquired the archived plots and tracks files from the DRP after the demonstration.

Results

The scheduled sampling event was performed and observed as documented in the subsequent set of screen captures of the DRP desktop. We acquired the screen captures using a utility on the DRP that generates image files of the current display when a predefined key is pressed, and names the files according to the local machine timestamp.

The first screen capture (Figure 6-60) shows the DRP display moments after the RRC received a “radar power on” command from the Auto-Scheduler. The RRC webpage was open on the desktop, and set to automatically refresh the radar screen display every 5 seconds. The radar

underwent a 4-minute initialization sequence on power-up before it was switched to transmit mode.

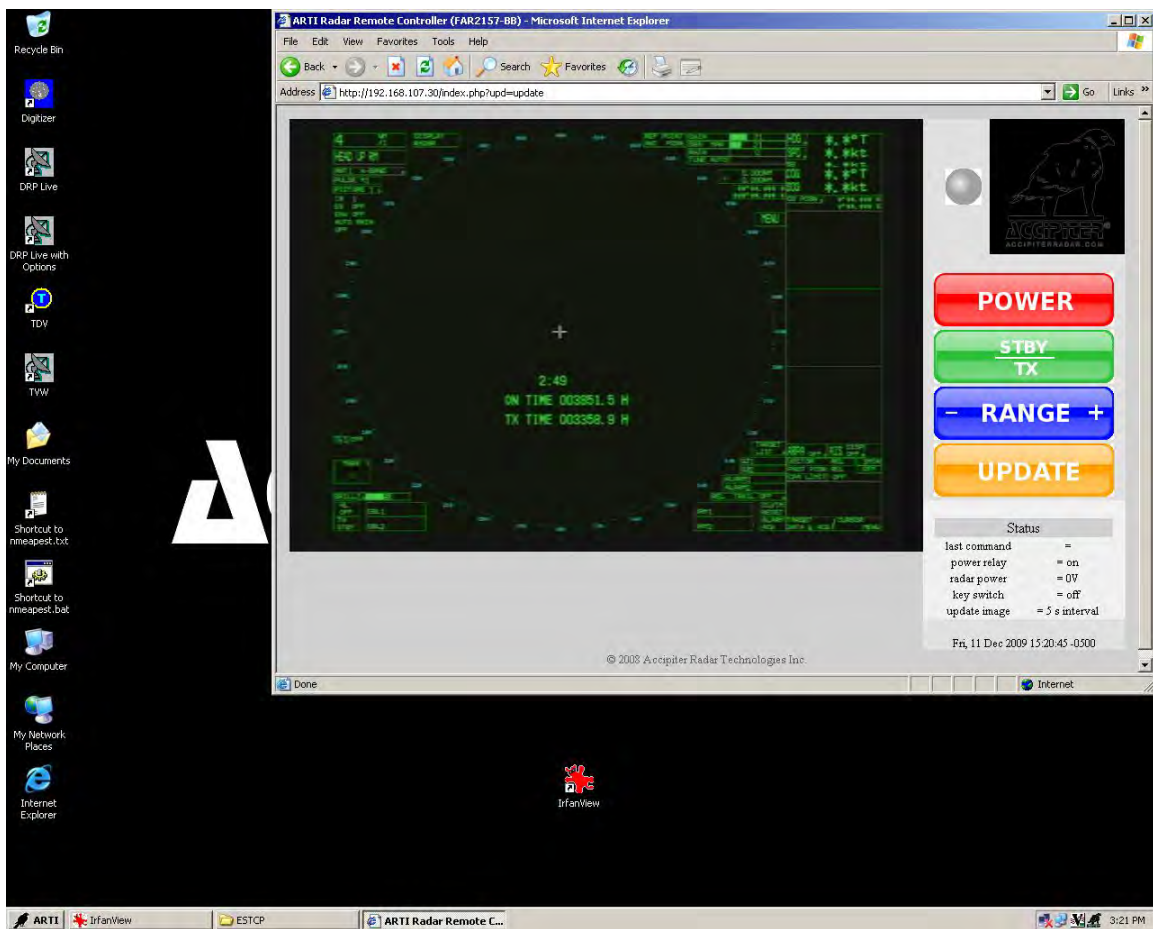

Figure 6-60. DRP desktop during raar initialization sequence.

At the end of the initialization sequence, the radar entered standby mode, and the Auto-Scheduler issued the appropriate commands for the radar to transmit in medium pulse mode. The (SeaScan) Digitizer application was also started on the DRP, and began digitizing the raw radar data (Figure 6-61):

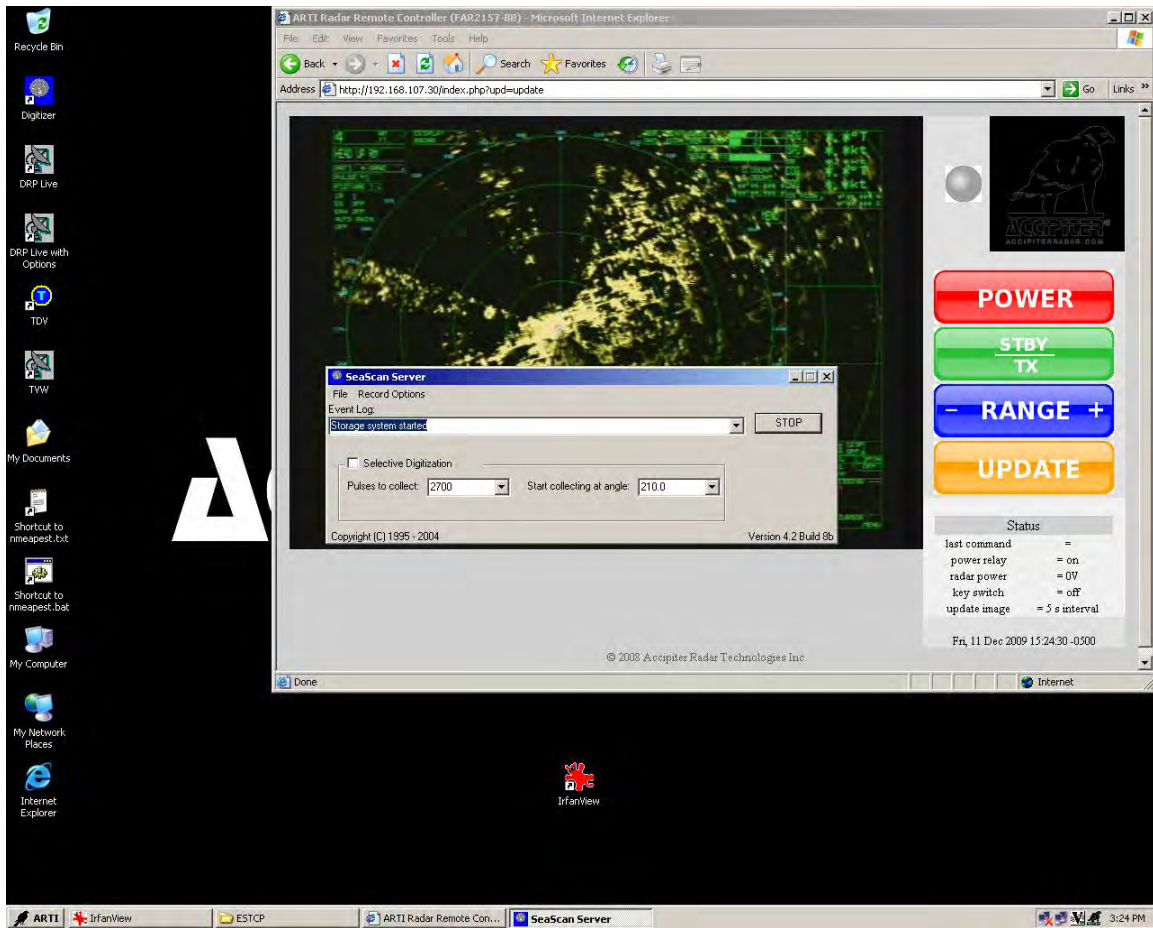

Figure 6-61. DRP desktop after “radar transmit” and “start Digitizer” commands.

The Auto-Scheduler then started DRP Live and sent the appropriate commands to set DRP Live to the desired operational mode (i.e., processing radar data and recording plots/tracks). The result of these commands is shown in Figure 6-62.

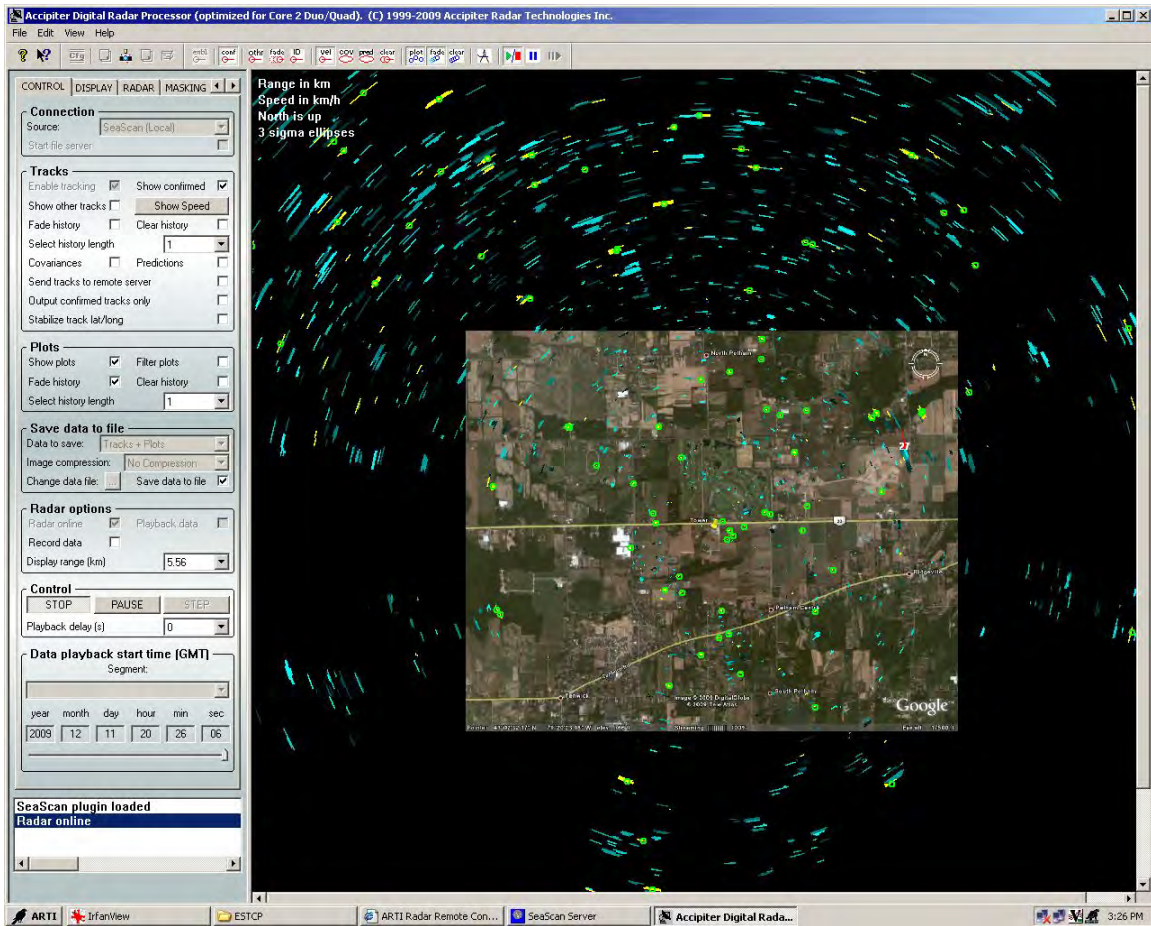

Figure 6-62. DRP Live application launched and processing started.

At the end of the sampling event, the Auto-Scheduler issued the appropriate commands to shut down DRP Live, the Digitizer, and the radar itself.

Table 6-19 includes excerpts taken from the Auto-Scheduler log file, along with an interpretation of each command.

Table 6-19. Auto Scheduler log entries with timestamps and meanings.

Log Entry	Corresponding Auto-Scheduler Task
Fri Dec 11 15:20:24 2009 debug: check for power at the radar	Radar power state check
Fri Dec 11 15:20:25 2009 debug: pwr_on = 1	Radar power on
Fri Dec 11 15:20:27 2009 debug: sleeping 240 s ...	Wait 4 min for radar initialization
Fri Dec 11 15:24:27 2009 debug: TX/STBY	Radar transmit
Fri Dec 11 15:24:47 2009 debug: set_pulse_width medium	Change pulse length to medium
Fri Dec 11 15:24:51 2009 debug: launch seascan ...	Start Digitizer

Table 6-19 (cont.).

Log Entry	Corresponding Auto-Scheduler Task
Fri Dec 11 15:24:59 2009 debug: drp_launch ...	Start DRP Live
Fri Dec 11 15:25:07 2009 debug: start tracker ...	Start DRP Live processing
Fri Dec 11 15:30:13 2009 debug: drp_stop = 1	Stop DRP Live processing
Fri Dec 11 15:30:13 2009 debug: drp_close = 1	Close DRP Live
Fri Dec 11 15:30:13 2009 debug: close seascan ...	Close Digitizer
Fri Dec 11 15:30:13 2009 debug: pwr_off = 1	Shut Radar off

A list of the plots/tracks recorded during the sampling event, and the associated start/end times are provided in Table 6-20.

Table 6-20. Plots and tracks files generated during test sampling event.

File Name	Start Time	End Time
TrackerOutput_20.25.12_Fri_11Dec2009.plots	15:25:12	15:30:14
TrackerOutput_20.25.12_Fri_11Dec2009.tracks	15:25:12	15:30:14

It is evident in Table 6-20 that plots and tracks recordings did not begin until approximately 5 minutes after the sampling event was started. This delay results from the time needed for initialization and to warm-up the magnetron in the radar unit. This delay should be incorporated into the schedule. The initiation time for sampling events should be set to start at least 5 minutes before the desired recording start time.

Conclusion

Performance Criterion PB2.2 was successfully demonstrated: The system was programmed in advance to power-on the radar, record plots and tracks data, and power-down the radar without human intervention. Screen captures of the event (during scheduling and execution), excerpts from the Auto-Scheduler log, and a list of the plots and tracks files generated during the test document completion of the criterion.

6.2.2.3 Sampling Controllable by Remote Operator [PB3.2]

Objective

We designed Performance Criterion PB3.2, Sampling Controllable by Remote Operator, to demonstrate that the avian radars the IVAR team is evaluating can be controlled and configured by an operator from a remote location. This is an important demonstration, as remote control of the radar facilitates system accessibility, even when the radar is located in a zone that is not easily reached by an operator (e.g., between runways at an airport).

PB3.2 is a qualitative Performance Criterion. We proposed to demonstrate that the remote control of the radar is “Achievable” by capturing a series of screen images that show the

commands we issued to the radar; that these commands were executed by the radar; and the corresponding effect of these commands had on the radar data processing.

Methods

We used two IVAR study locations for this demonstration: SEA (remote) and ARTI (local). We selected the SEAR21 rooftop radar at SEA because it is remote (>3300 km from ARTI) and has a convenient Internet connection. It also has sufficient network bandwidth to support the Virtual Network Computing (VNC) connection we planned to use for real-time remote control of the DRP from ARTI, as well as providing visual confirmation that commands sent to the remote radar were quickly received and executed.

We chose ARTI as the location from which to control the operation of the remote radar because the necessary components were already installed and operational there, including the VNC software, the web-based RRC, and the necessary network connectivity. Our demonstration layout at ARTI is depicted in Figure 6-63. In the right window on a PC workstation, we ran an instance of the RRC that provided us with a view of the radar display and the corresponding radar controls, while in the left window we opened a VNC connection to the SEAR21 DRP (i.e., the “DRP Live” application), which supplied us with the digitized radar feed and live target information from the remote SEAR21 DRP. This configuration also provided us with the timestamps from the remote DRP and the local workstation. With this layout we were able to issue commands to the remote radar and view the corresponding effect on the digitized radar data.

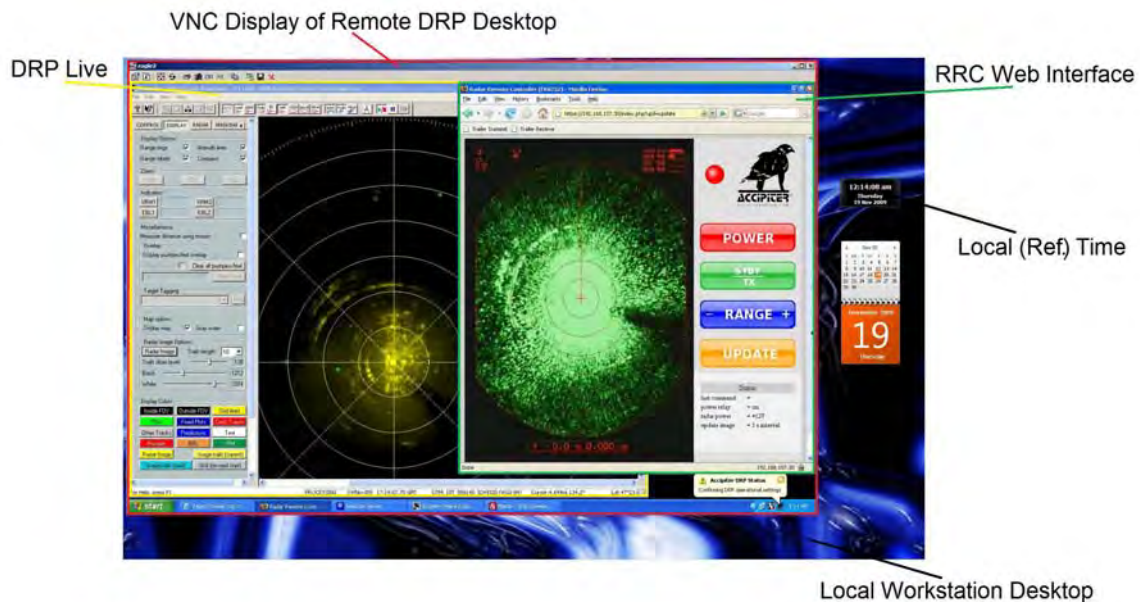

Figure 6-63. Test layout for demonstration of remote radar control.

The RRC web interface provides a live display of the radar screen and selectable controls for issuing operational commands to the radar. A detailed view of the RRC web interface is provided in Figure 6-64.

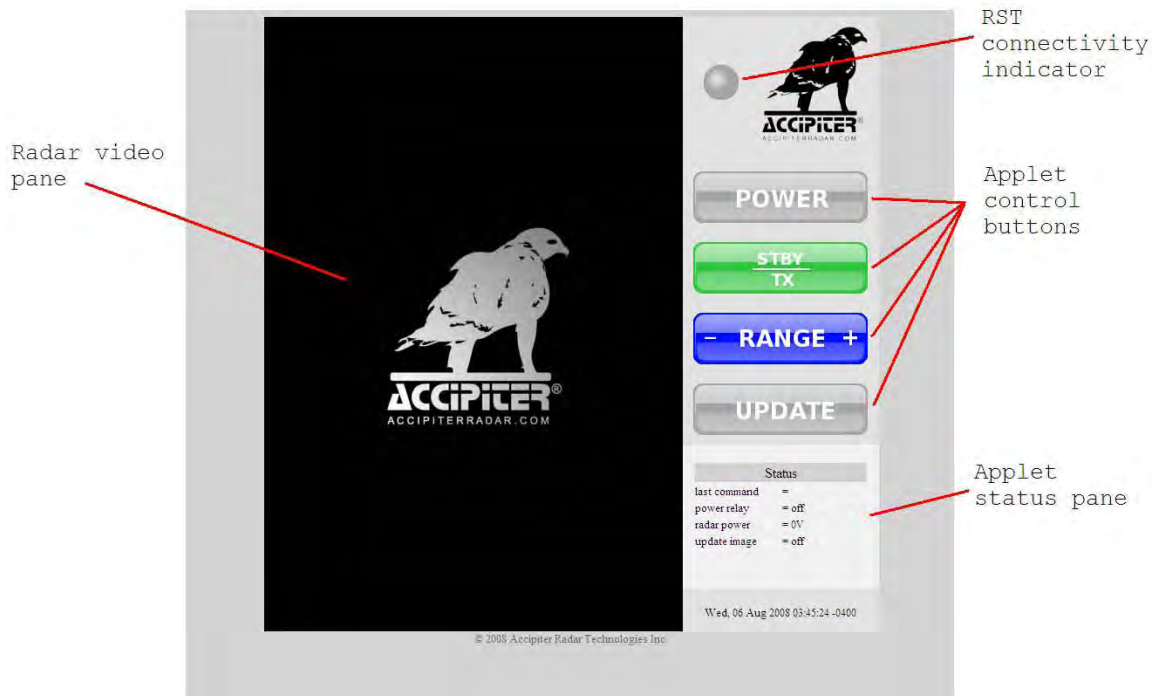

Figure 6-64. Elements of the RRC web interface.

We used the following test procedure to demonstrate the ability of the RRC to issue commands to the radar:

- Using the appropriate control button in the RRC web interface, we issued one of the following commands to the radar:
 - Increase range
 - Decrease range
 - Standby
 - Transmit
 - Power off
 - Power on
- We took a screen capture of the DRP Live display to provide visual confirmation that the command had been executed.

After executing a series of commands, we returned the settings of the SEAR21 radar to those used for normal operation. We then transferred the plots and tracks files that had been generated during the test to the workstation at ARTI.

Before we started the demonstration, the radar was transmitting, the DRP was processing live radar data, and plots/tracks were being recorded. The following sequence of commands was issued to the radar using the RRC during the test:

1. Standby
2. Transmit
3. Range Increase (x4)

4. Range Decrease (x7)
5. Range Increase (x3)
6. Standby
7. Power Off
8. Power On
9. Transmit

To document the demonstration of remote control of a remote radar, we prepared a table of our observations of the SEAR21 radar's responses, as evidenced by the DRP Live window, to the sequence of commands listed above and executed through the RRC application.

Results

Table 6-21 presents the observations recorded during the demonstration. The "State" columns refer to the state of the remote radar, as read from the RRC web interface (and seen in the corresponding screen captures). The "Visual Confirmation of Execution" column refers to visual proof and/or timestamps from plots and tracks files that support the conclusion that each command was performed by the radar.

Table 6-21. Recorded observations from demonstration of PB3.2.

Step in Sequence	State				Last Command	Visual Confirmation of Execution	Observations
	Power	Mode	Range (km/nmi)	Pulse			
Pre-test	on	tx	5.5/3	LP	N/A	N/A	Normal radar operating conditions.
1	on	stby	5.5/3	LP	Standby	yes	STBY message on radar screen. DRP Live processing stopped automatically.
2	on	tx	5.5/3	LP	Transmit	yes	Radar image visible on radar screen. DRP Live processing started.
3	on	tx	89/48	LP	Range Increase (x4)	yes	Saw incremental increase in range for each command issued. Subtle changes seen in DRP Live radar image.
4	on	tx	0.9/0.5	SP	Range Decrease (x7)	yes	Saw incremental decrease in range for each command. DRP Live radar image decreased in size.
5	on	tx	5.5/3	LP	Range Increase (x3)	yes	Incremental range increases seen. Plots/Tracks recording stopped twice during pulse length changes (SP to MP to LP).
6	on	stby	5.5/3	LP	Standby	yes	STBY message seen on radar screen. Plots/tracks recording stopped automatically
7	off	N/A	N/A	N/A	Power Off	yes	Radar screen went blank, switched to Accipiter logo. Plots/tracks recording still stopped, last radar image still visible on DRP screen.
8	on	stby	5.5/3	LP	Power On	yes	Radar screen visible during power-on/warm-up sequence. Automatically returned to stby. Plots/tracks recording still stopped.
9	on	tx	5.5/3	LP	Transmit	yes	Returned to normal radar operating conditions. Plots/Tracks recording restarted.

“TX” = Transmit; “STBY” = Standby; “LP” = Long pulse; “MP” = Medium pulse; “SP” = Short pulse

Figure 6-65, Figure 6-66, and Figure 6-67 are screen captures that show sequence Steps 1, 2, and 3, respectively, in Table 6-21.

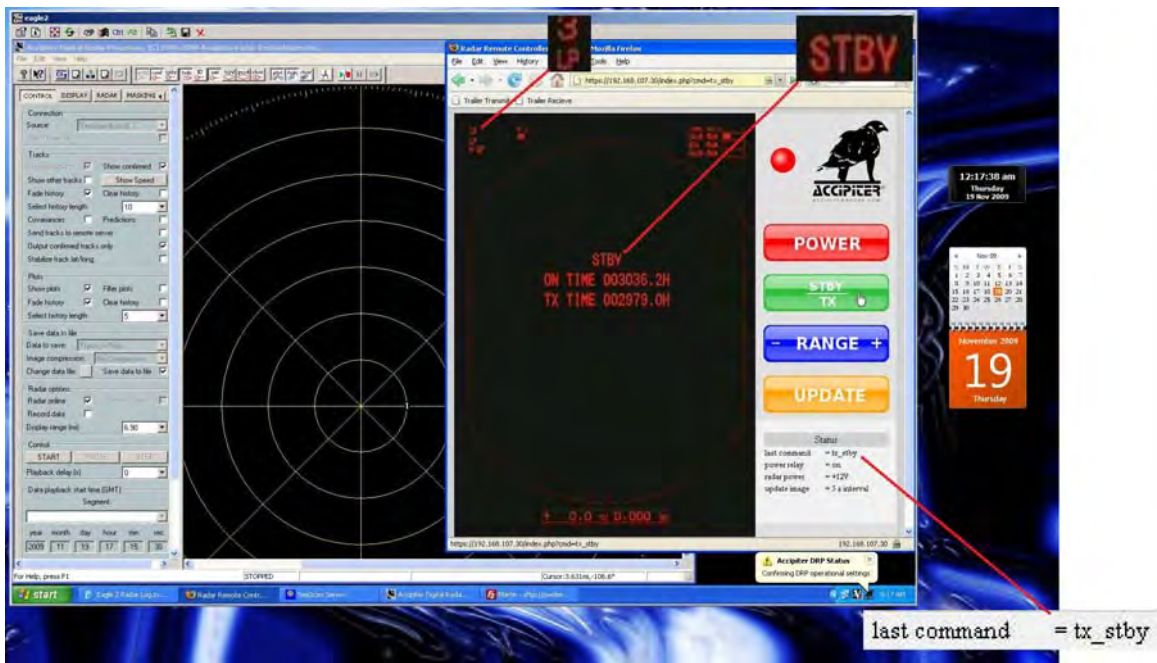

Figure 6-65. Sequence step 1: standby command issued to radar.

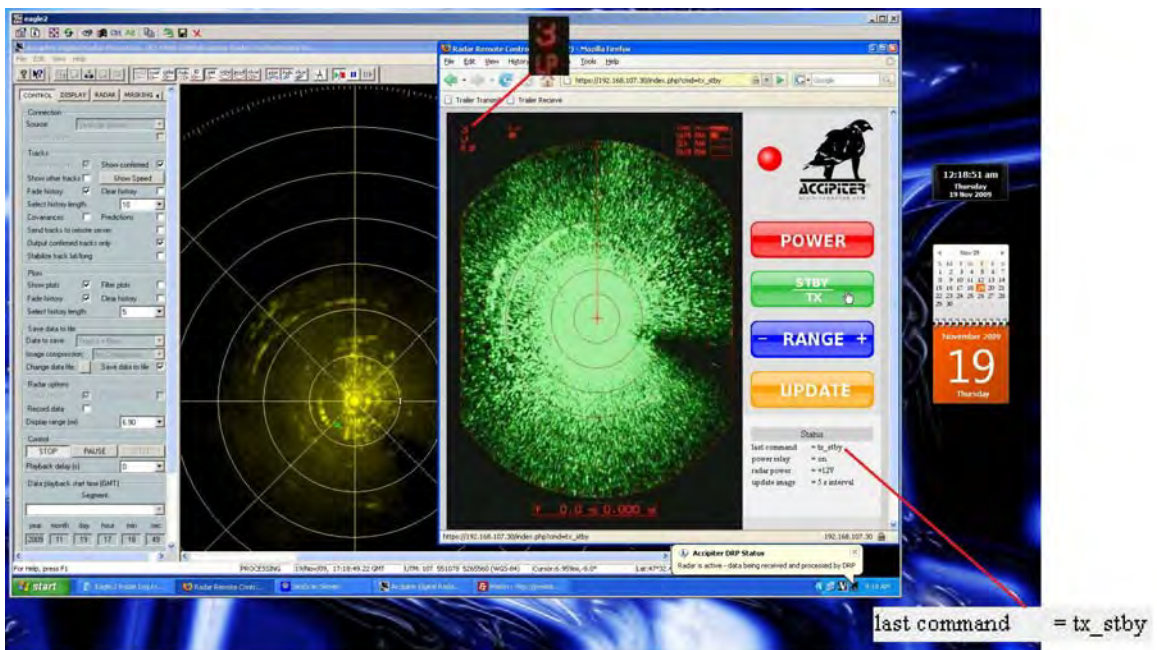

Figure 6-66. Sequence step 2: transmit command issued to radar.

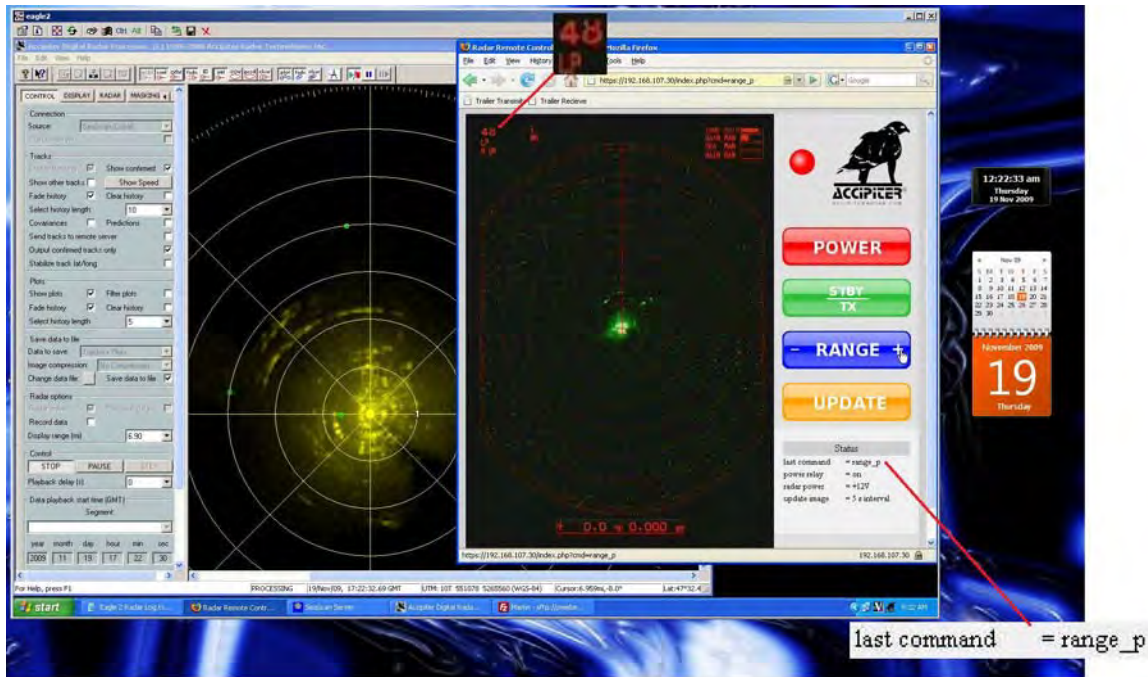

Figure 6-67. Sequence step 3: 4 range increase commands issued to radar.

As illustrated in Figure 6-65 through Figure 6-67, the screen captures provided visual confirmation that each of the issued commands was executed by the radar. The power state, mode, range, pulse length, and last command can be seen (and verified with **Table 6-21**) for these screen captures.

We obtained visual confirmation that each of the commands issued to the radar was executed.

Conclusion

We successfully demonstrated Performance Criterion PB3.2, Sampling Controllable by Remote Operator. Commands were issued to a remote radar (the SEAR21 rooftop radar at SEA) from ARTI, and visual confirmation was obtained that each of the commands was executed.

Remote control of the following radar commands, through the RRC web interface, has been demonstrated:

- Power on
- Power off
- Standby
- Transmit
- Range increase
- Range decrease

The RRC web interface provides a remote operator with control over any Internet-connected radar from any remote location – one of the major requirements of potential end-users.

6.2.2.4 Provides Spatial Distributions of Birds over Periods of Time [PB4.2]

Objective

We designed Performance Criterion PB4.2, Provides Spatial Distributions of Birds over Periods of Time, to demonstrate the ability of the avian radar systems evaluated by the IVAR project to display spatial representations of bird activity over user-definable intervals of time.

Knowledge of bird movement patterns is crucial for wildlife management and for flight planning and aviation safety in general. The TVW application gives users the ability to playback archived data and save spatial representations of target activity over user-definable periods of time: This is referred to as [track] history generation.

The TVW application can also be set to generate histories using live data streamed directly from an RDS. Histories provide users with a visual representation of all target activity that was seen by the radar for a specified period of time. The spatial distribution of targets (relative to the radar) is visible in the display. We have employed these track history files in several other demonstrations of Performance Criteria (e.g., PB1.1, PB5.2, and PB9.2).

We will demonstrate Performance Criterion PB4.2 by generating histories from a single radar installation over a 24-hour period, during different seasons of the same year.

Method

In order to demonstrate Performance Criterion PB4.2, we chose a suitable (fixed) radar installation that had reasonably high uptime over a full year of operation. We selected the SEAR21 rooftop radar for this purpose: Specifically, we chose 24-hour archived plots and tracks datasets from three different days over a 1-year period

- 13 January 20
- 20 April 2009
- 19 October 2009

These dates were selected to represent winter, spring and fall, respectively. We replayed each of the 24-hour plots/tracks datasets in the TVW application. We set the history length to 24 hours, which generated one 24-hour history for each of these days.

We replayed the 19 October dataset in the TVW application for a second time, setting the history length to 2 hours and generating 12 2-hour histories from this dataset.

Results

A track history is a two-dimensional spatial distribution of all target activity that was seen by a radar for a given period. In this demonstration, we generated a 24-hour history from the SEAR21 rooftop radar for each of the following days in 2009: 13 January, 20 April, and 19 October.

Each of the histories was aligned with true north and centered on the position of the SEAR21 radar (47.441748° North, 122.300488° West). The relative range of each track can be read directly from the histories.

Figure 6-68 is a 24-hour history from the SEAR21 radar on 19 October 2009:

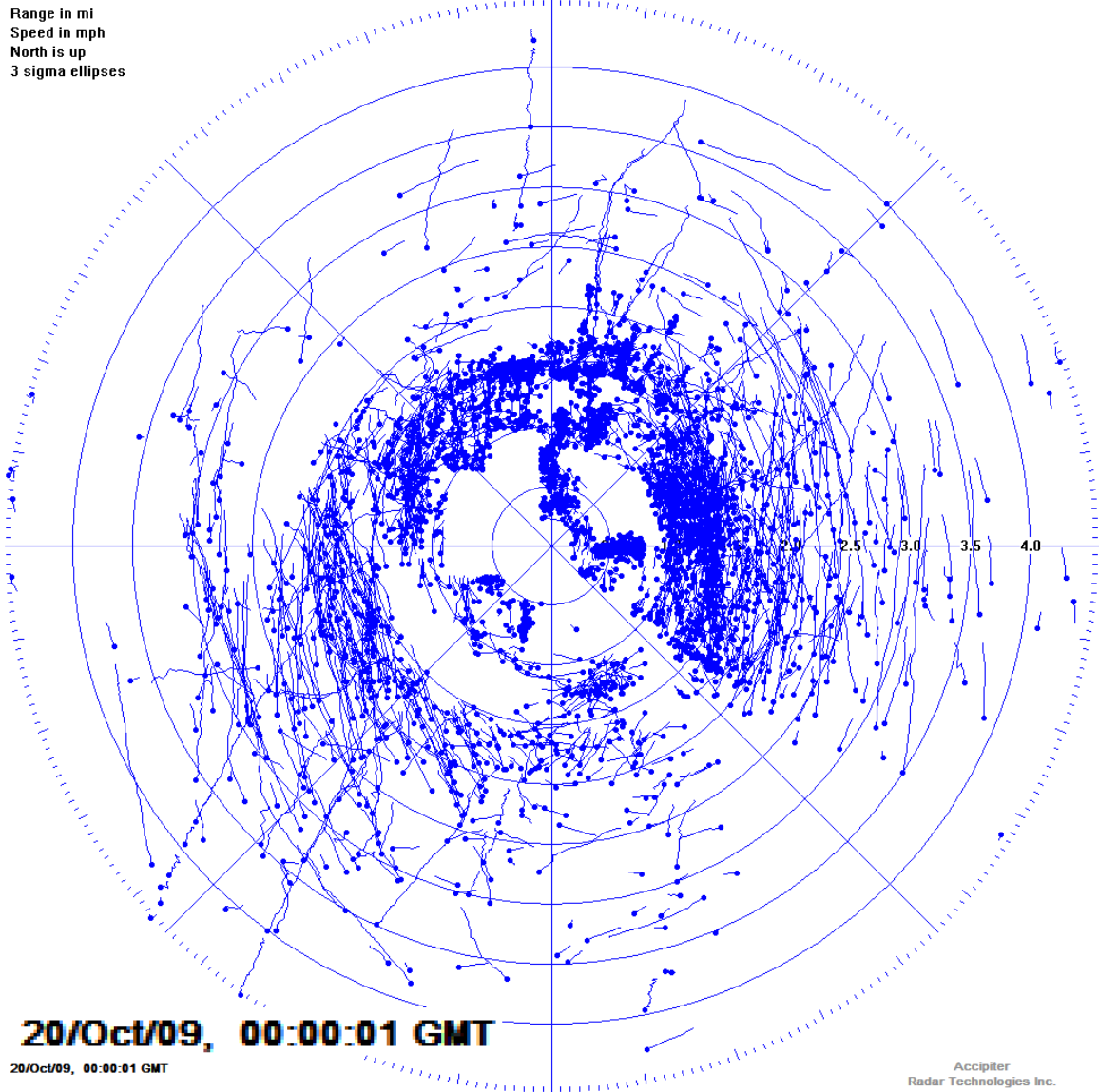

Figure 6-68. A 24-hour history plot of the track activity from the SEAAR11 radar at SEA on 19 October 2009.

We enlarged the timestamp in the lower-left corner of the history plot. This timestamp identifies the last track update that was included in the history. We set the maximum range in the history plot to 7.24 km (4.50 miles), and each range ring represents a 800-m (0.5-mile) increment. The last update (or the end) of each track is identified with an enlarged dot at the head of the track.

The 24-hour history from 20 April is shown in Figure 6-69:

Range in mi
Speed in mph
North is up
3 sigma ellipses

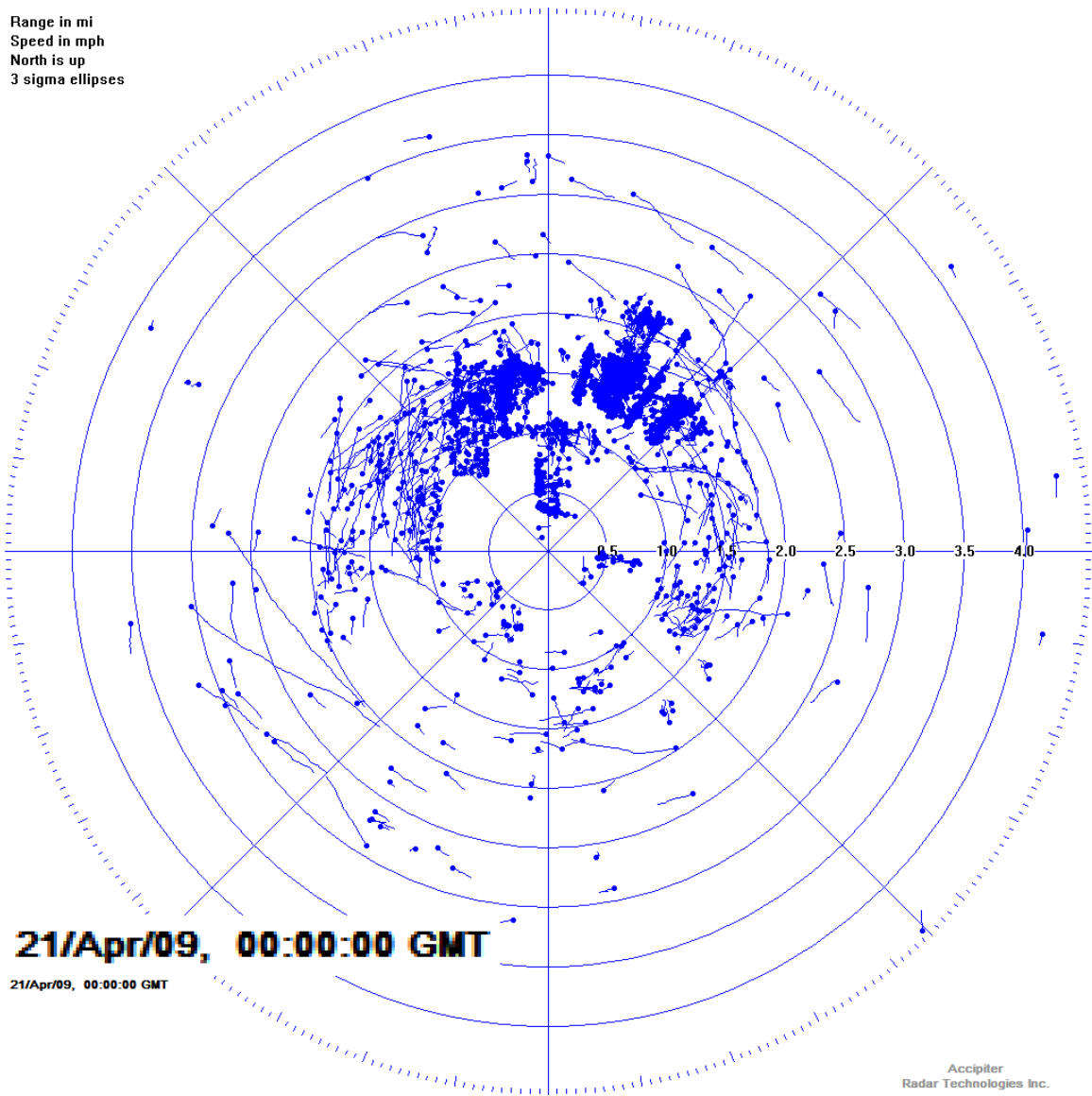

Figure 6-69. A plot of all track activity during a 24-hour period from the SEAAR11 radar at SEA on April 20, 2009.

Likewise, Figure 6-70 is a 24-hour history plot from 13 January 2009 .

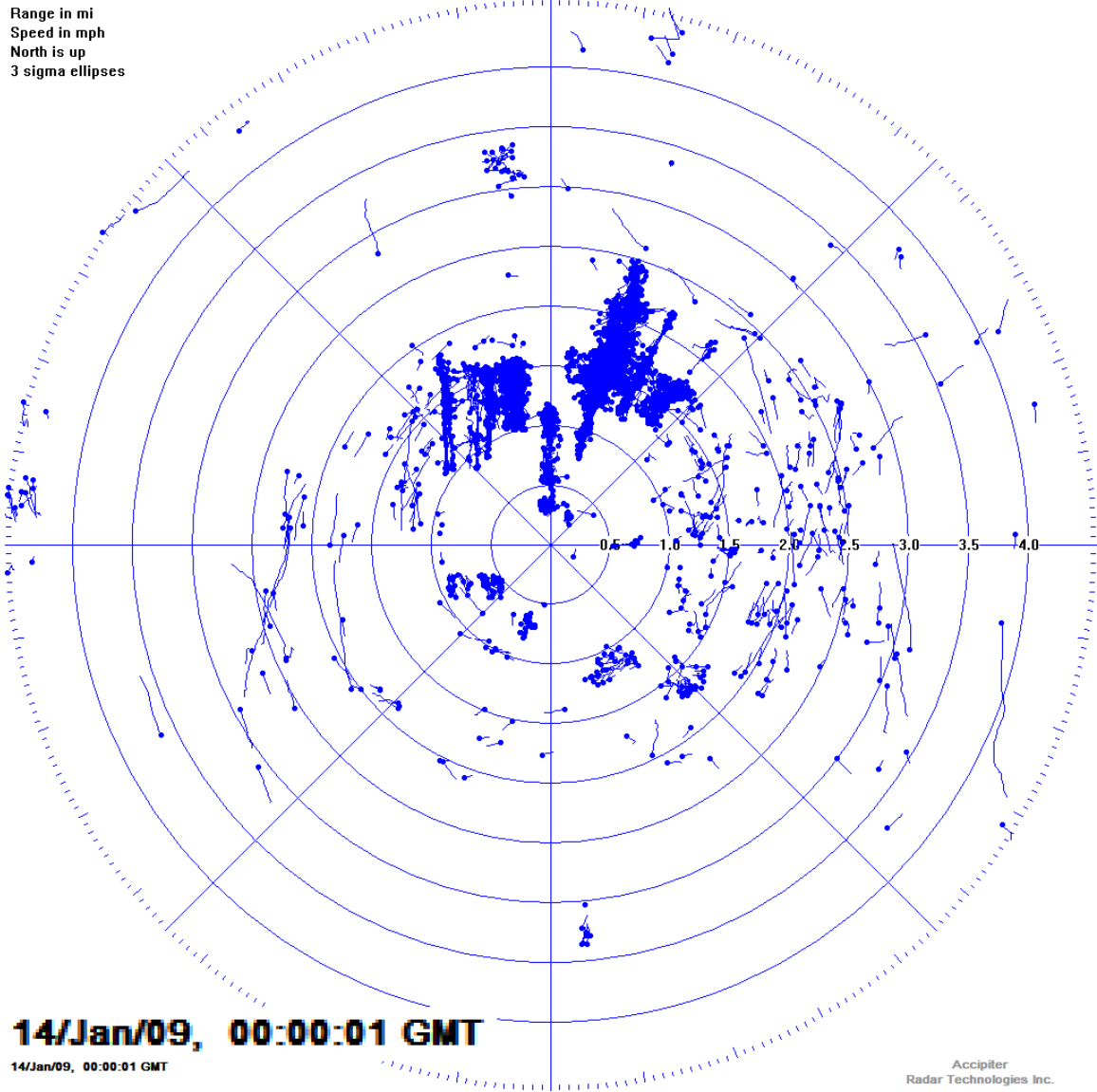

Figure 6-70. A plot of all track activity during a 24-hour period from the SEAAR11 radar at SEA on 13 January, 2009.

In order to demonstrate history generation over a shorter time period, as used for finer-grain analysis of target activity, we replayed the dataset from 19 October 2009 for a second time in the TVW, with the history length set to 2 hours. Figure 6-71 provides a tiled image of all 12 histories generated for in this manner.

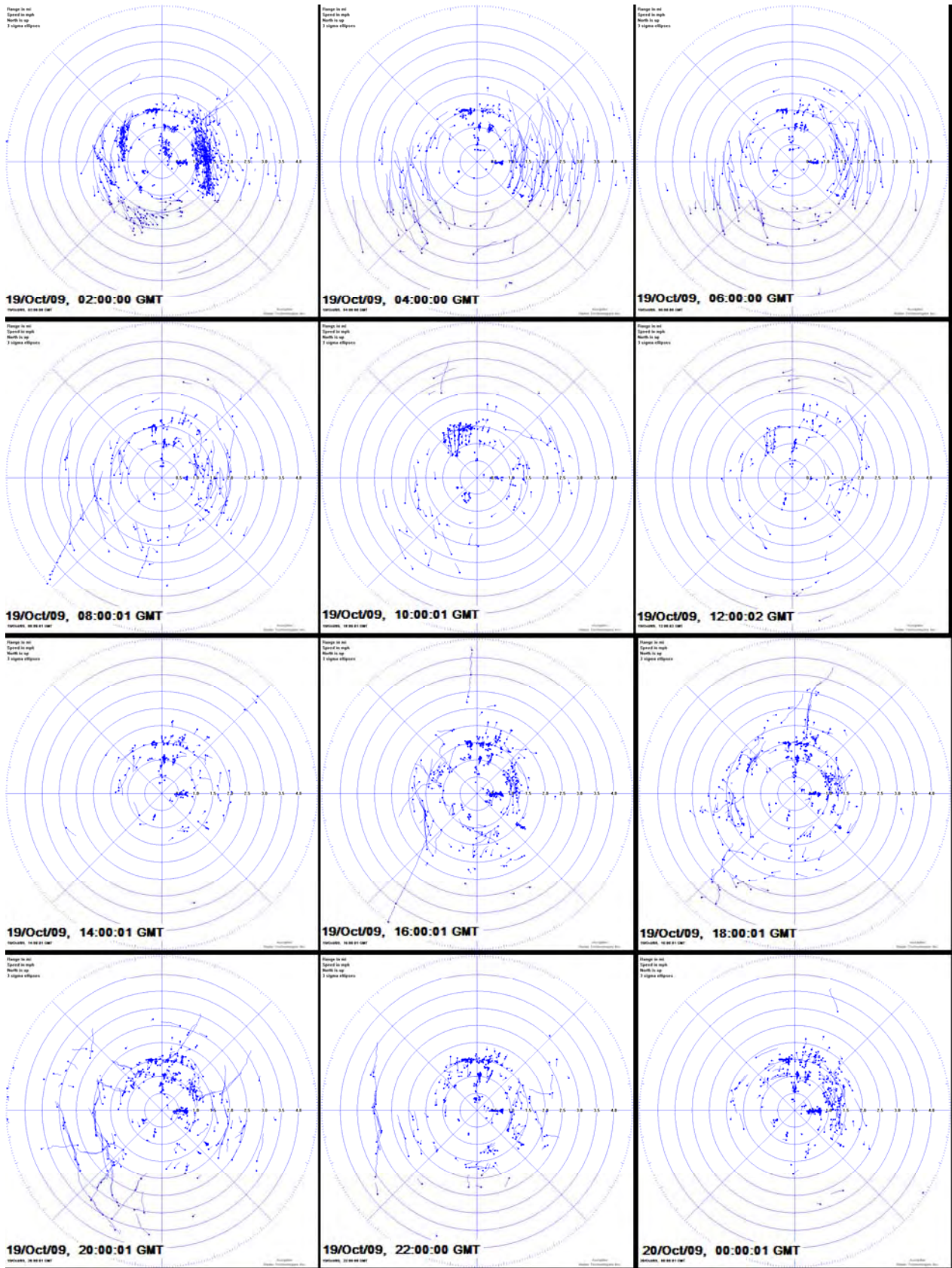

Figure 6-71. Twelve 2-hour histories produced from the SEAR11 radar for 19 October 2009.

Conclusion

Performance Criterion PB4.2, Provides Spatial Distributions of Birds over Periods of Time, has been successfully demonstrated for three 24-hour periods representing winter, spring and fall bird activity captured by the SEAAR11 radar at SEA. The system has the ability to display spatial representations of bird activity over user-definable intervals of time.

6.2.2.5 Provides Spatial Distributions of Birds Overlaid on Maps [PB5.2]

Objective

We designed Performance Criterion PB5.2 to build on Performance Criterion PB4.2 (Section 6.2.2.4) by demonstrating an additional feature of the TVW application: Its ability to display track data over a background map.

The presence of a background map gives system users a geographical reference for target activity seen on the radar display. Spatial distributions of bird activity, over any user-defined interval of time, can be overlaid on a site map to facilitate both real-time and post-processing identification of areas of high bird activity.

We will demonstrate Performance Criterion PB5.2 is “Achievable” by re-generating the track histories used in PB4.2 and overlaying them on several background maps.

Methods

For the demonstration of PB5.2, we used a plots and tracks dataset that had been recorded by the SEAAR21 radar at SEA on 19 October 2009: This was the same dataset we used to demonstrate Performance Criterion PB4.2. We replayed this dataset in the TVW application and generated a 24-hour history, which we then overlaid on a background map of SEA. At the same time, we generated a kml file from the same 24-hour dataset for viewing with a 3-dimensional earth browser as a comparison to the TVW display.

Results

Figure 6-72 shows the spatial distribution of target activity, as seen by the SEAAR21 radar on 19 October 2009, that we generated using the TVW application and its aerial map of the area surrounding SEA.

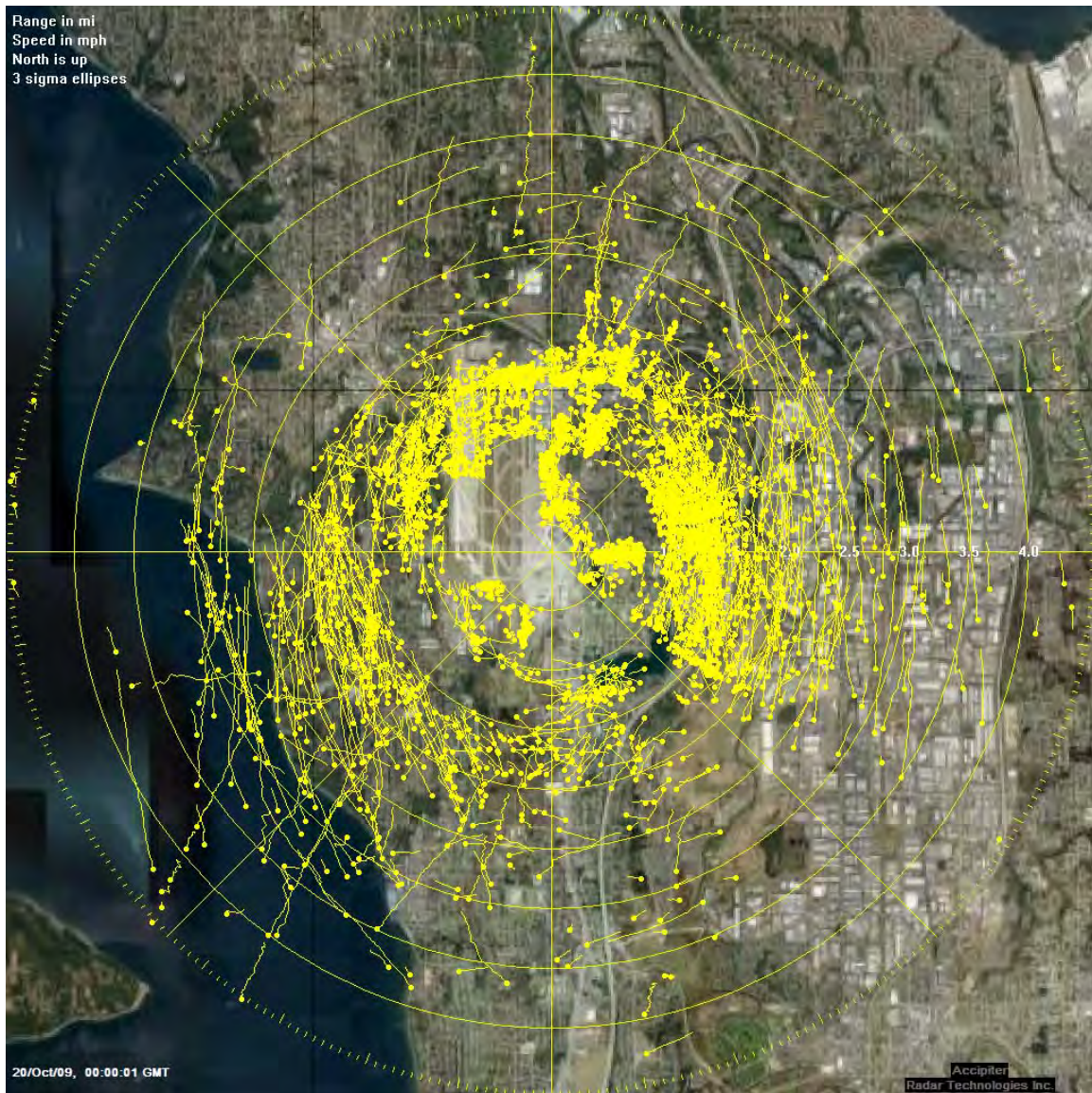

Figure 6-72. TVW application display of the track histories from SEAAR21 radar for a 24-hour period 19 October 2009. The track histories are overlain on a digital aerial image of the area surround the SEATAC International Airport.

The history in Figure 6-72 is identical to the one produced for PB4.2 (**Figure 6-68**), with the exception that the background map of SEA has been added.

The history panel of the TVW application includes a “SAVE KML” option that, if enabled, generates a Keyhole Markup Language (kml²¹) version of the track histories that can be viewed in a 3-dimensional earth browser. Figure 6-73 is a screen capture of the kml history for the 19 October 2009 dataset, displayed in Google Earth.

²¹ <http://en.wikipedia.org/wiki/Kml>

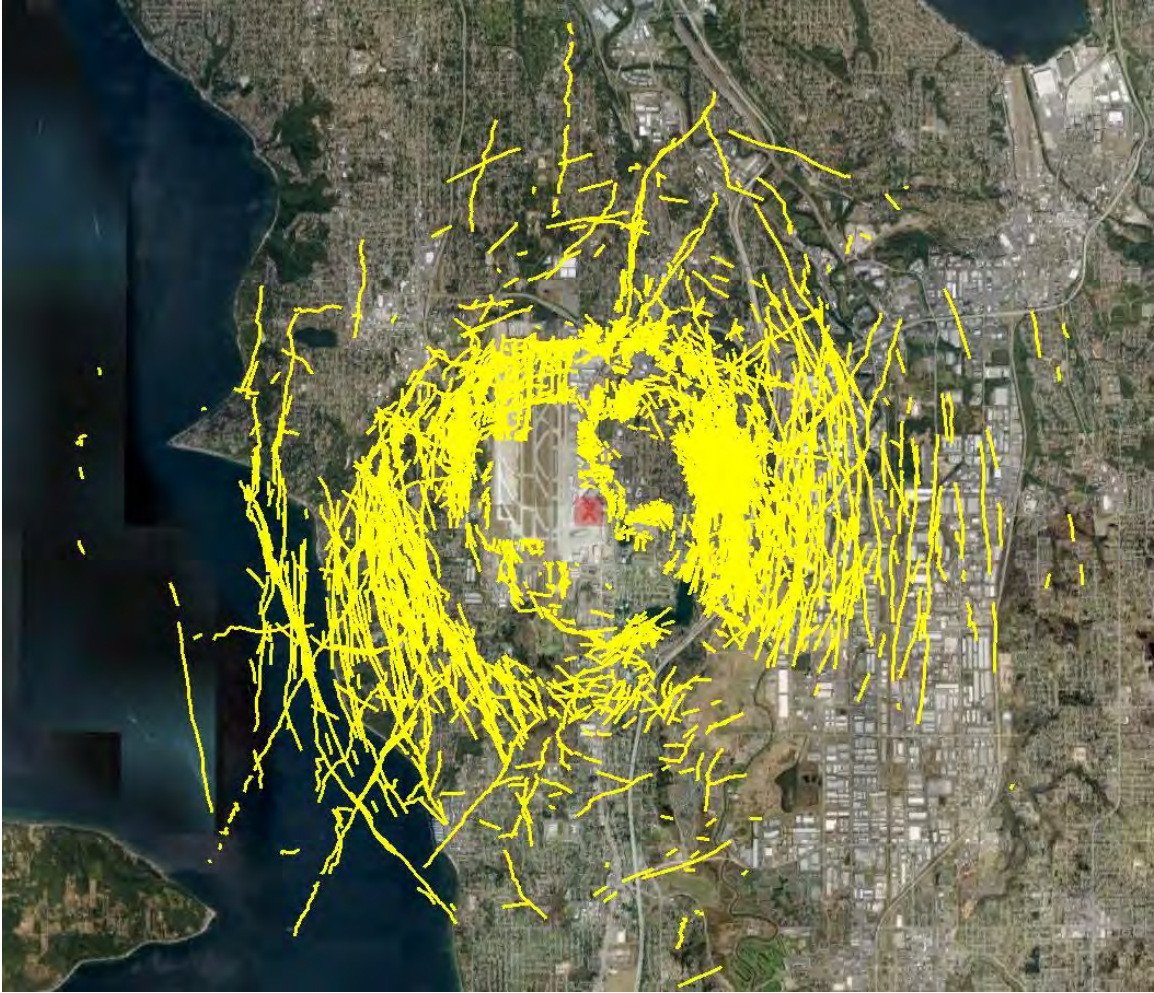

Figure 6-73. 24-hour kml history.

The kml histories provide users with a rough approximation of target heights, which are resolved along the centerline of the beam for each track. Figure 6-74 is a profile view of the kml history data from the SEAR21 radar on 19 October 2009, displayed in Google Earth.

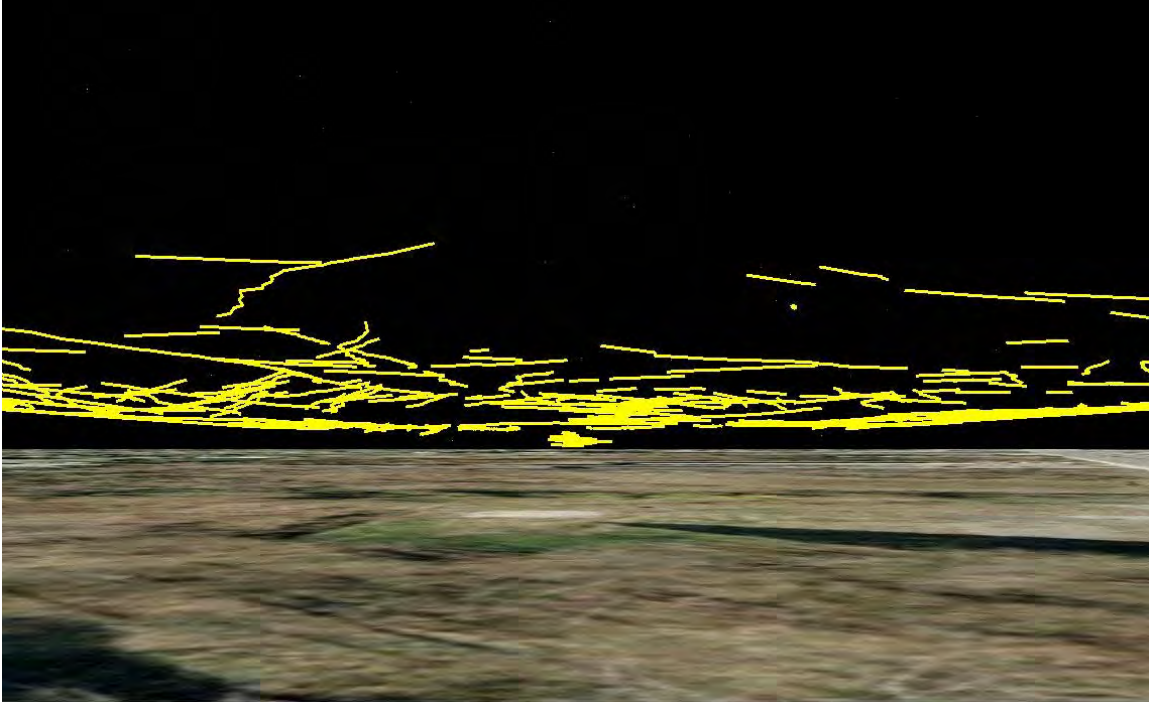

Figure 6-74. Oblique view of kml history, illustrating track height information.

Conclusion

We have demonstrated that Performance criterion PB5.2, Provides Spatial Distributions of Birds Overlaid on Maps, is achievable by the radar systems evaluated by the IVAR project. Figure 6-72 through Figure 6-74 demonstrate that these systems are capable of producing spatial distributions of targets overlaid on background maps, along with kml histories that include height information.

6.2.2.6 Provides Bird Tracks in Format Suitable for GIS [PB6.2]

Objective

We designed Performance Criterion PB6.2, Provides Bird Tracks in Format Suitable for GIS, to demonstrate that the avian radar systems being evaluated by the IVAR project provide sufficient geographical information in the plots and tracks data they generate to support displaying these data in a geographic information system, (GIS).

The Accipiter® software, including the DRP, TVW, and RFE already generates georeferenced data, as we have illustrated in several of the other IVAR performance criteria. In this section we will further demonstrate that live target data can be extracted in near-real time and viewed in a 3-dimensional earth browser, that spatial distributions of birds can be saved as kml histories, and that the TDV application enables a user to select individual tracks and export them to the kml format.

We established as the success criterion for PB6.2 that the ability of the Accipiter® applications to make use of and/or extract GIS data from processed target records was “Achievable”.

Method

We explored the plots and tracks data structure using the TDV application to illustrate the data fields that are saved for each scan of the radar, including those fields that would be required as input to a GIS. We exported selected tracks in the kml format, which is a widely used language that links target data to its corresponding location in earth coordinates so the data can be represented in 2- or 3-dimensions in a GIS application. Finally, we viewed some of these data in a 3-dimensional earth browser.

Results

The DRP saves GIS-relevant data in every track update. The relevant data fields can be extracted from plots and tracks data files or from the RDS database. Once extracted, the data can be exported in kml, a widely used open-source GIS format. The extraction process can be done in real time or by post-processing archived data.

The following are three examples of extracting geospatial data from plots and tracks data and using a GIS to display these data.

Real-Time Data to a GIS

We demonstrated the near real-time extraction of GIS data in Performance Criterion SD2.1 (Section 6.4.1.2). In the present demonstration, we extracted and wrote target data to kml, and served the data from the RDS, all in real time. We then used Google Earth to view the live target data (served from the RDS) from all three SEA radars simultaneously - see Figure 6-75. To distinguish between the different feeds from the three radars, we configured Google Earth to color-code the targets and the corresponding timestamps from each radar.



Figure 6-75. Live feed from three radars at SEA, as viewed in Google Earth.

Archived Data to a GIS

We used the TDV application to illustrate extracting GIS data from archived data. The TDV can extract and display the following information from any set of plots and tracks files: date, track ID, scan time, number of updates, latitude, longitude, speed, heading, height, RCS, intensity, range, azimuth. [Section 6.1.1.2 provides a more detailed description of the information available from the plots and tracks data files using the TDV application.] Once a user selects an individual track, s/he can export the track data to the kml format and view them with 3-dimensional earth browser (e.g., Google Earth); Figure 6-76 is an example of such a display.



Figure 6-76. An individual track exported to kml format and viewed in Google Earth.

Track Histories to a GIS

A third method to extract GIS data from real-time or archived target data is to use the TVW application to generate track histories. As described in PB5.2 (Section 6.2.2.5), a track history provides a spatial distribution of bird activity over any user-defined period of time. Histories can be saved in kml format for viewing in a 3-dimensional earth browser such as Google Earth, as illustrated in Figure 6-77:

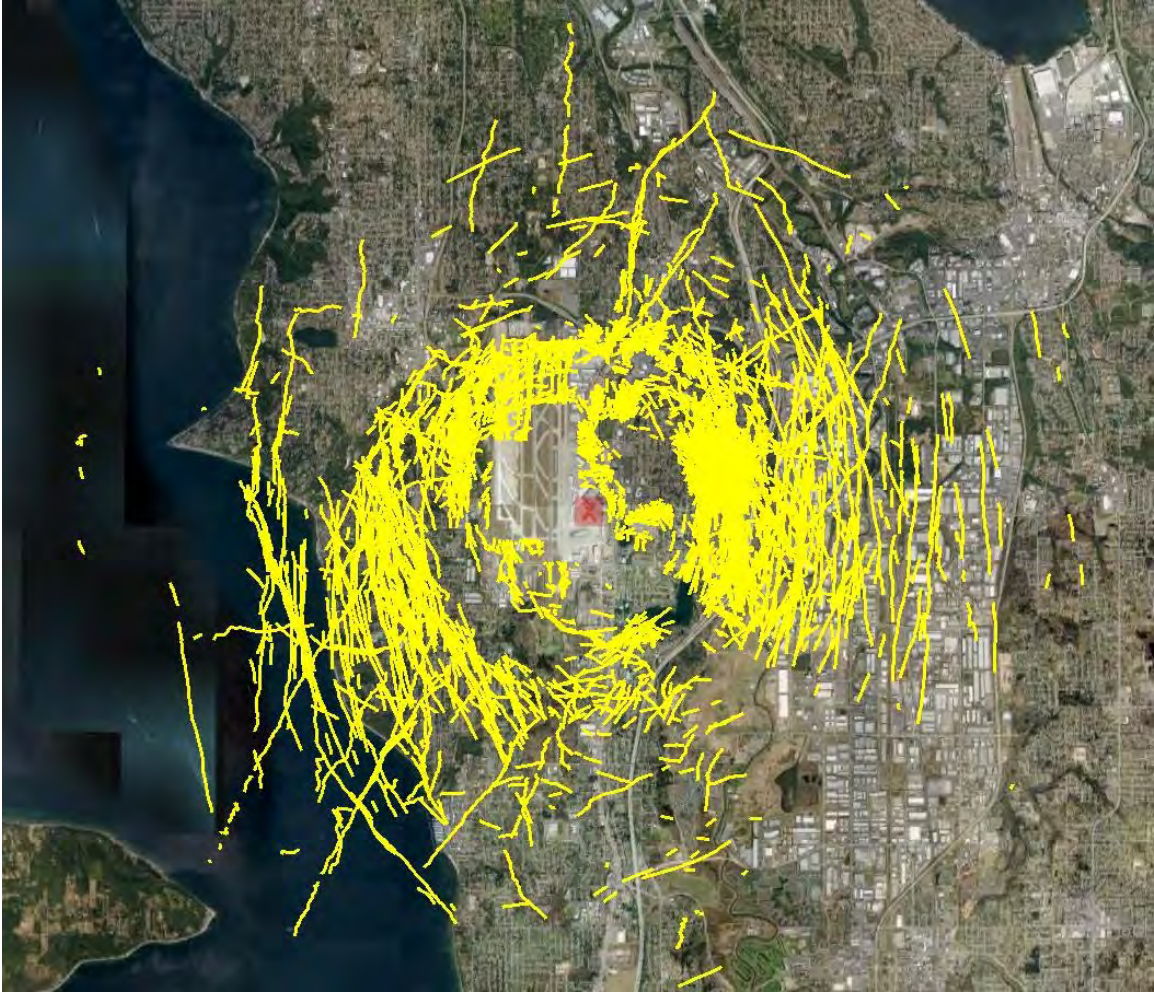

Figure 6-77. A Google Earth display of a track history from SEA. This display was generated using data generated by the TVW application and exported in the kml format.

Conclusion

We have successfully demonstrated Performance criterion PB6.2 by illustrating three ways in which the avian radar systems evaluated by the IVAR project can display and/or export track data in a format suitable to input by a GIS.

6.2.2.7 Provides Bird Abundance over Periods of Time [PB7.2]

Objective

Our goal when we designed Performance Criterion PB7.2 was to demonstrate the ability of the digital avian radar systems the IVAR project is evaluating to accumulate number-of-targets (abundance) data over specified periods of time. This ability will be important for anyone who wants to analyze patterns of daily, seasonal, annual, and inter-annual bird activity.

The most powerful method of generating abundance data is to extract it directly from the RDS, which includes a relational database that can be accessed using the Structured Query Language

(SQL). Extracting target data from the RDS involves structuring and performing queries to retrieve data based on specific criteria. A query can extract target counts over any time period, and filter them according to any combination of the following criteria: speed, heading, range, duration, latitude/longitude, intensity, height, azimuth, target ID, and start time.

The data extracted from the RDS and used to demonstrate PB7.2 apply equally well to PB8.2, Provides seasonal comparison distributions. We therefore combined the demonstration of PB7.2 and PB8.2 into one analysis, reported in this section. Inasmuch as PB7.2 and PB8.2 are qualitative Performance Criteria, we proposed to demonstrate them by displaying bird abundance data collected from SEA over a full year and presenting the target counts over hourly and daily intervals, with the latter presentations spanning the four seasons of a year as well.

Methods

In order to demonstrate Performance Criteria PB7.2 and PB8.2, we chose a suitable radar and dataset from it. We selected the SEAR21 radar because it experiences few outages during regular operation, and it has a high-speed (wired) connection to the Internet. We chose the interval December 2008 to November 2009 as the dataset to demonstrate bird abundance data because it had few discontinuities.

We wrote and executed the SQL query described below:

- The dataset was defined by identifying its “start” and “stop” timestamps as: 1 December 2008 00:00:00 GMT, and 30 November 2009 23:59:59 GMT, respectively.
- The (counting) interval was defined (hourly/daily).
- We structured the query to create a unique track ID for each track in a given interval. This unique ID was a combination of the track ID and the track start time.
- The query saved the values of maximum velocity and duration for each track. This enabled post-query track filtering, ensuring that only tracks of interest were counted (i.e., with speeds above 0 m/s with at least 1 update).
- We executed the query, which generated an output text file was containing the timestamps of each interval and the corresponding track counts. An example can be seen in Table 6-22.

Table 6-22. Output from hourly track count query from the SEAR21 radar.

Interval Number	Interval Timestamp (UNIX Time)		Hourly Count	Date (mm/dd/yyyy)	Start Time (GMT hh:mm:ss)
	Start	Stop			
1	1228089600	1228093199	332	12/1/2008	00:00:00
2	1228093200	1228096799	329	12/1/2008	01:00:00
3	1228096800	1228100399	316	12/1/2008	02:00:00

We used the files generated from this query as the basis for our analyses and graphic representation of bird abundance counts using Microsoft Excel®.

Results

The SEAR21 radar was originally intended to operate in “short pulse” mode, looking for small targets out to approximately 4.0 km (2.5 miles) in range. This was changed on October 27, 2009,

as the radar was switched to “long pulse” mode, which favored targets between (approximately) 4 and 11 km in range. This resulted in the lower track counts that are evident in the counts after that date (**Figure 6-78**).

Avian radars are tuned for their surroundings (in this case SEA), and adjustments are made as needed. This first-order tuning optimizes detection parameters for tracking bird targets. There is, however, a trade-off between radar sensitivity and false detections: The radar will see all bird activity within its coverage area, but will also display elevated track counts caused by large insects, precipitation, aircraft, and other objects that exhibit bird-like behavior. We have not filtered the track counts presented in this analysis, and thus they may be elevated because of the presence of such false tracks.

All interval timestamps were adjusted to local (Pacific) time before the data were plotted to facilitate the correlation between UTC and the time at SEA when viewing the track count plots.

Our first analysis was a daily track count for the SEAAR21 radar over the full-year dataset, shown in **Figure 6-78**.

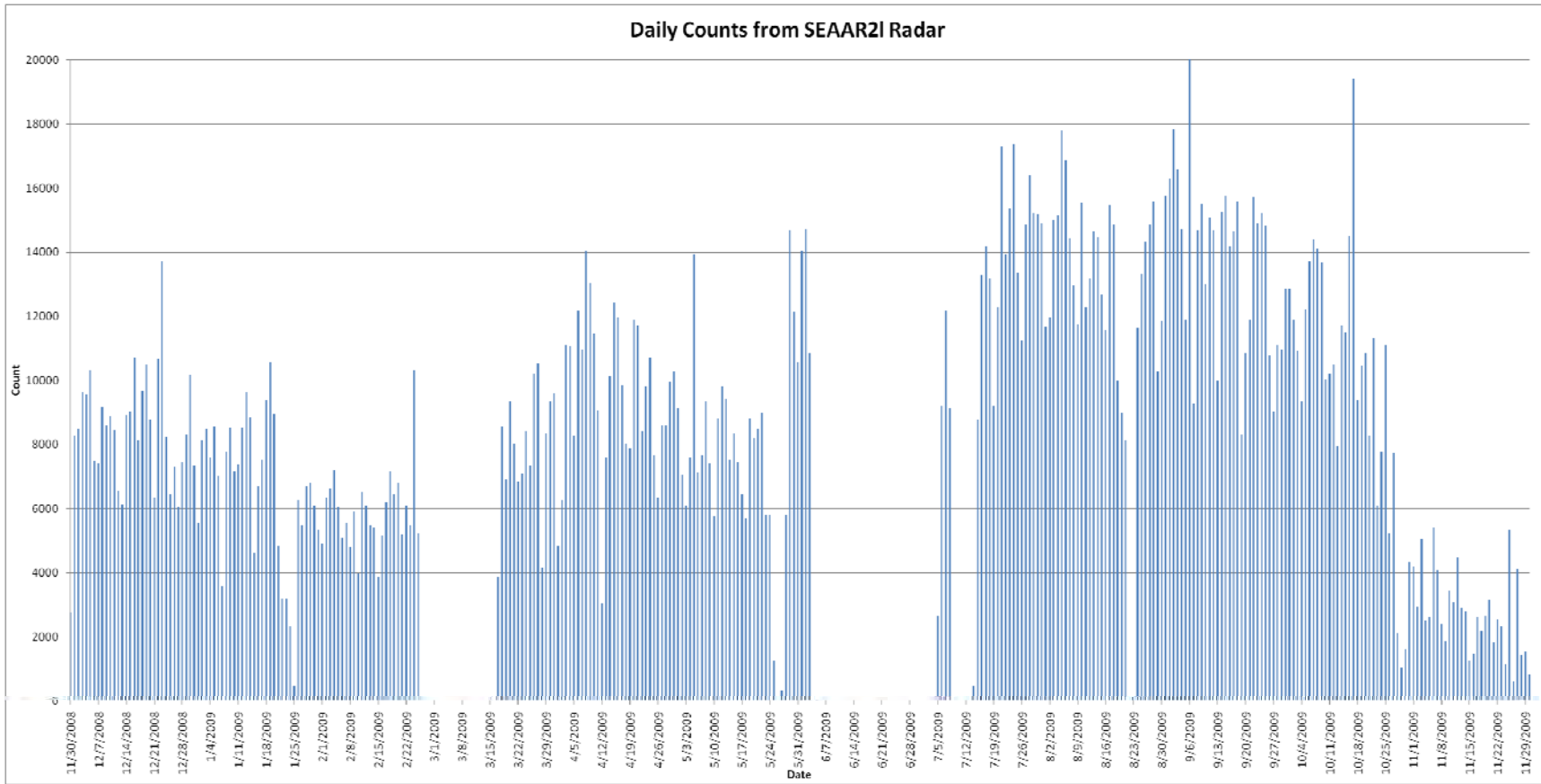

Figure 6-78. Daily, unfiltered, track count as recorded by the SEAR21 radar over a full year, 01 December 2008 to 30 November 2009.

There are obvious gaps in the data collection seen in **Figure 6-78**. These gaps occurred because the SEAR21 radar is installed on the rooftop of a building at SEA and radar operations were occasionally interrupted for reasons beyond our control, including: construction, regular maintenance in the vicinity of the radar, network and power outages, and other unforeseen events affecting system operation.

Figure 6-78 demonstrates both the distribution of both short-term (daily) and longer-term (seasonal) changes in abundance of targets for one year at SEA. Obviously, one would require even longer timelines for comparison of seasonal activity from year-to-year in order to look for longer term trends in these activity patterns.

From the full-year dataset, we selected the following three 5-day periods:

- 12/1/2008 – 12/5/2008
- 4/13/2009 – 4/17/2009
- 9/21/2009 – 9/25/2009

We then plotted hourly track counts for these three time periods. The selected dates are highlighted in red in Figure 6-79.

We selected these three time periods arbitrarily, based only on the condition that they did not include extended outages in radar operations. Figure 6-80, Figure 6-81, and Figure 6-82, respectively plot the hourly track counts for these three time periods.

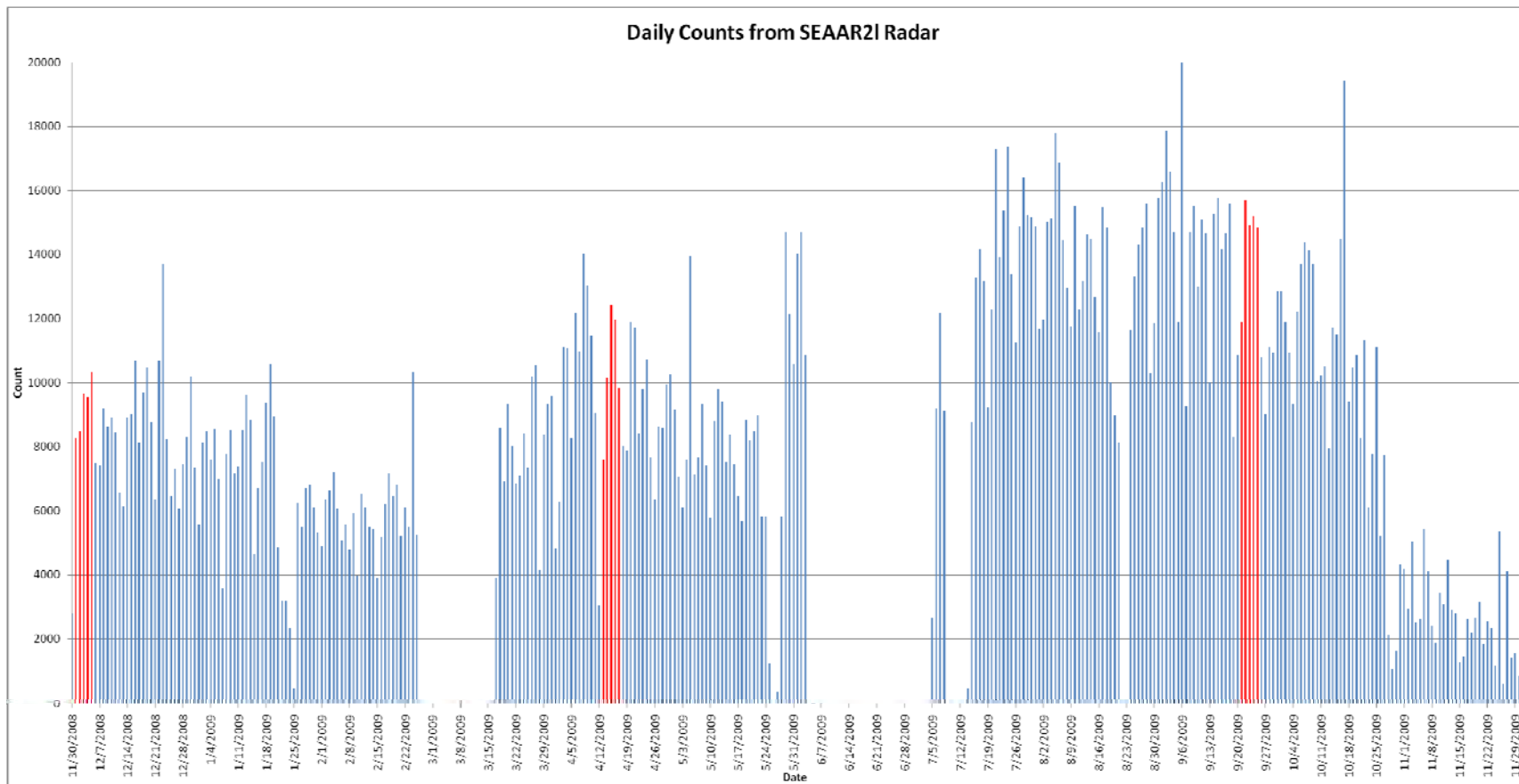

Figure 6-79. Time periods selected for representation as hourly track counts in Figure 6-80 through Figure 6-82.

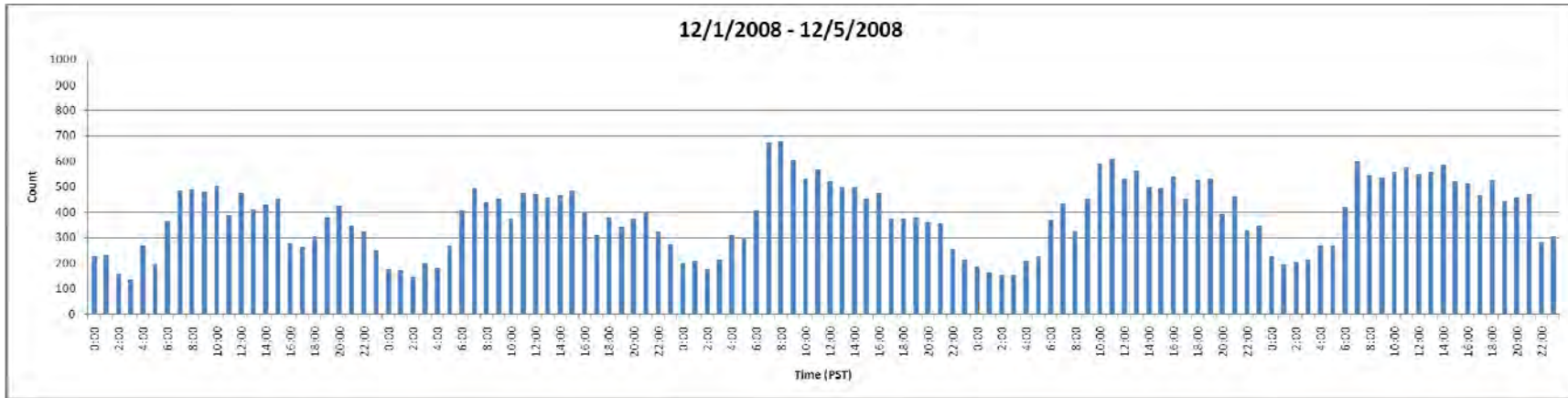

Figure 6-80. Hourly track count over the period of 1-5 December 2008.

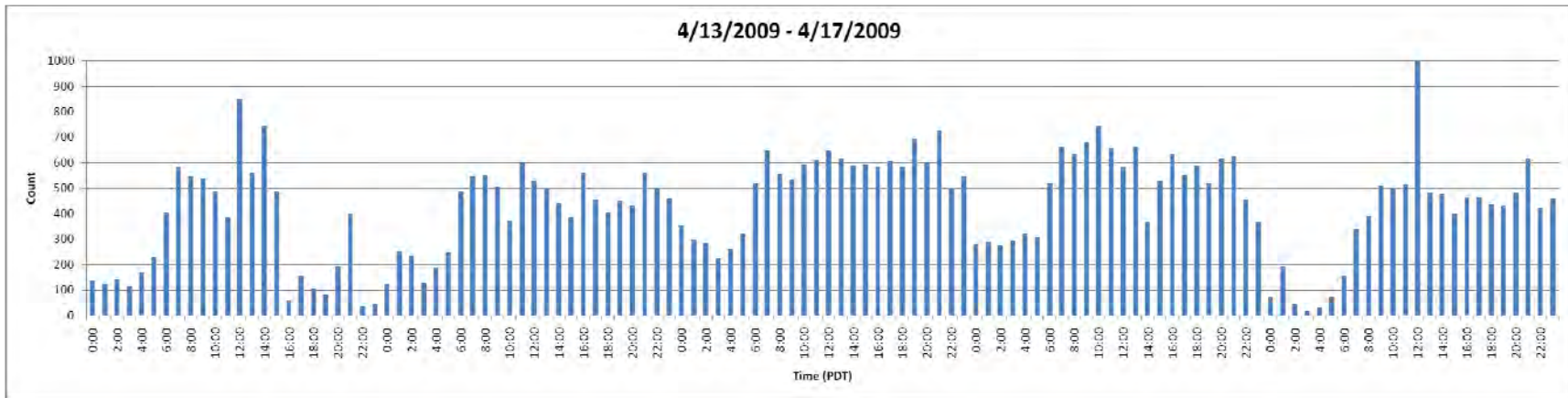

Figure 6-81. Hourly track over the period of 13-17 April 2009.

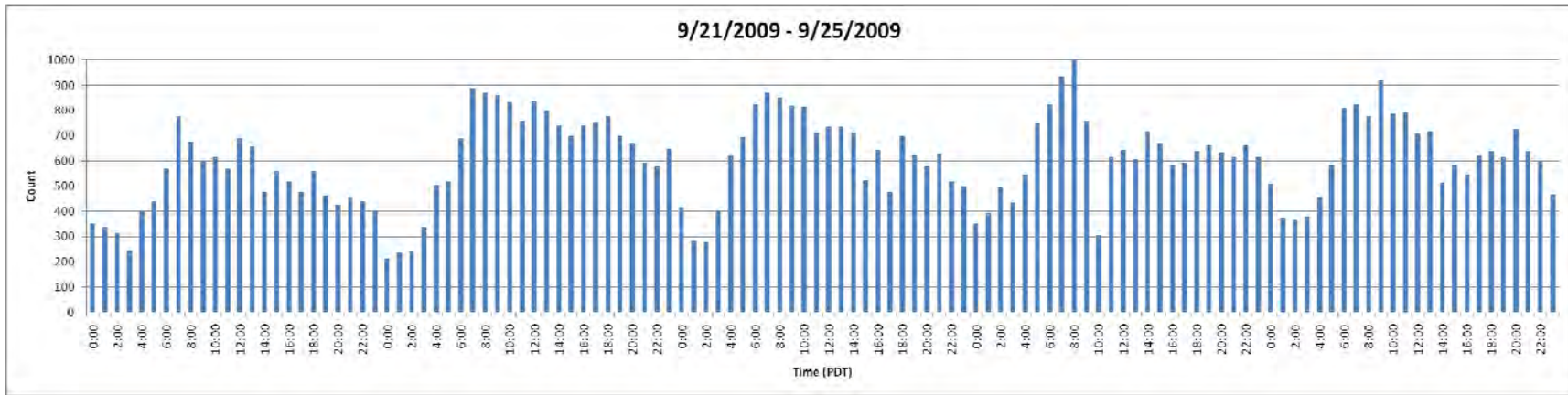

Figure 6-82. Hourly track count over the period of 21-25 September 2009.

Cyclical trends in the distribution of target activity are apparent in the hourly track counts. Comparing the patterns between the three figures also illustrates differences in the seasonal abundance of targets. As would be expected, the greatest amount of activity occurred during the day and the lowest around midnight. These periods of relatively high and low activity correspond with other observations of bird activity at SEA (Steve Osmek and Edwin Herricks, personal communication). Track count filtering and further analysis of these results is on-going, as is the comparison of these patterns from one year to the next.

Conclusion

We have successfully demonstrated Performance Criteria PB7.2 and PB8.2 by collecting bird abundance data over a one-year period at SEA and then extracting and displaying the distribution of those data over both hourly and daily time periods. Along with PB1.1 (Section 6.2.1.1), which demonstrated (at NASWI, in that case) that both the AR- and eBirdRad-type radars can be operated continuously 24/7, the results presented here demonstrate these avian radar systems are capable of gathering bird abundance data day and night over long periods of time – a necessary requirement in a wide range of temporal analyses.

6.2.2.8 Provides Seasonal Comparison Distributions [SB8.2]

The demonstration of PB7.2 has been incorporated in Performance Criterion PB7.2 (Section 6.2.2.7).

6.2.2.9 Samples Birds at Night [PB9.2]

Objective

Our objective for Performance Criterion PB9.2 was to demonstrate the capability of the avian radar systems evaluated by the IVAR project to sample birds at night.

The ability to sample birds at night is one of the primary advantages of avian radar over other methods of sampling birds, and this capability is especially important for systems that are intended to provide around-the-clock situational awareness of bird activity.

In this demonstration, we present hourly trends and track histories to illustrate that using avian radar systems to sample bird activity at night is “Achievable”.

Method

We demonstrated aspects of Performance Criterion PB9.2 indirectly as part of several other performance criteria, criteria where nighttime sampling was part of the study design (e.g., PB1.1, Section 6.2.1.1; PB4.2, Section 6.2.2.4; PB5.2, Section 6.2.2.5; PB7.2, Section 6.2.2.7). We have used some of the same data here, specifically focused on sampling birds at night. In particular, we identified extended periods of continuous operation of the SEAR21 rooftop radar at SEA and generated track counts and histories to illustrate the target activity that was seen by the radar at night.

Results

We identified a 5-day period of continuous operation of the SEAR21 radar and exported the track updates for this period. From these track records we generated hourly track counts over the entire period (12/1/2008 to 12/5/2008) and use Microsoft Excel® for analysis and display. The

results are displayed in Figure 6-83. **Table 6-23** lists the times of sunset and sunrise for the dates included in this demonstration.

Table 6-23. Time of sunset and sunrise at Seattle, Washington on the dates used for the demonstration of PB9.2.

Date	Sunset (PST)	Sunrise (PST)
1 December 2008	16:20	07:37
2 December 2008	16:19	07:39
3 December 2008	16:19	07:40
4 December 2008	16:18	07:41
5 December 2008	16:18	07:42

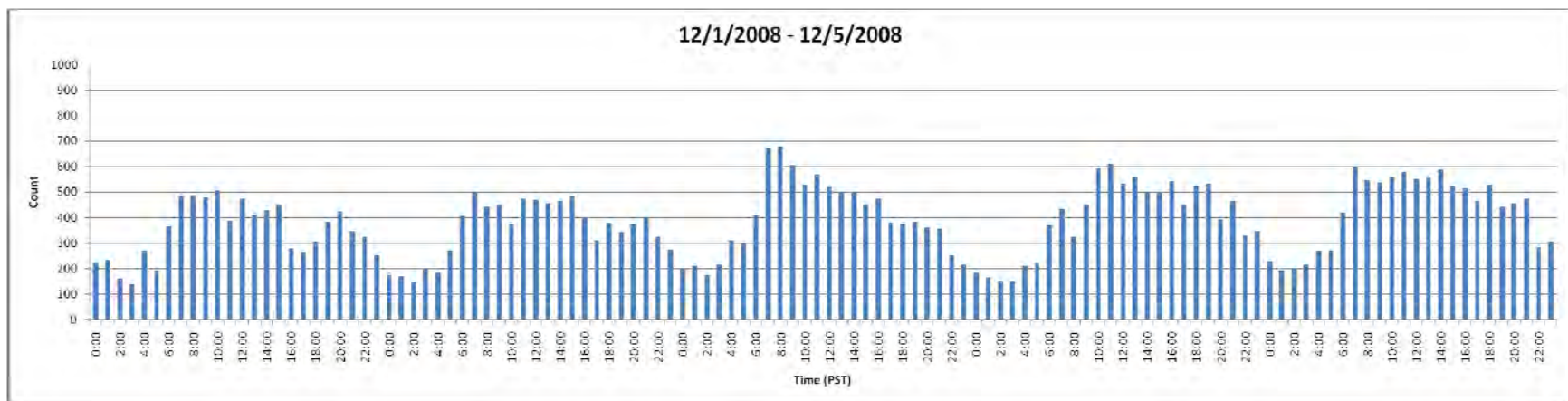

Figure 6-83. Hourly track count for targets tracked by SEAR21 radar at SEA between 1 December 2008 and 5 December 2008.

As can be seen in Figure 6-83, the radar tracked 100 or more targets every hour for the entire 120-hour period, including the approximately 15 hours between sunset and sunrise on each of these dates.

We analyzed a 24-hour set of plots and tracks from the SEAR21 DRP on 19 October 2009 to establish the daily pattern of avian activity. We replayed the plots and tracks using the TVW application to produce 12 2-hour histories for the full 24-hour period: Figure 6-84 is a tiled image of those 12 track histories²². Sunset and sunrise were approximately 01:13 UTC and 14:34 UTC, respectively, on this date.

²² The times displayed in **Figure 6-84** are shown in UTC; the corresponding Pacific Daylight Time (PDT) values would have been seven hours earlier at SEA: 19:00 18 on October 2008 through 17:00 on 19 October 2009.

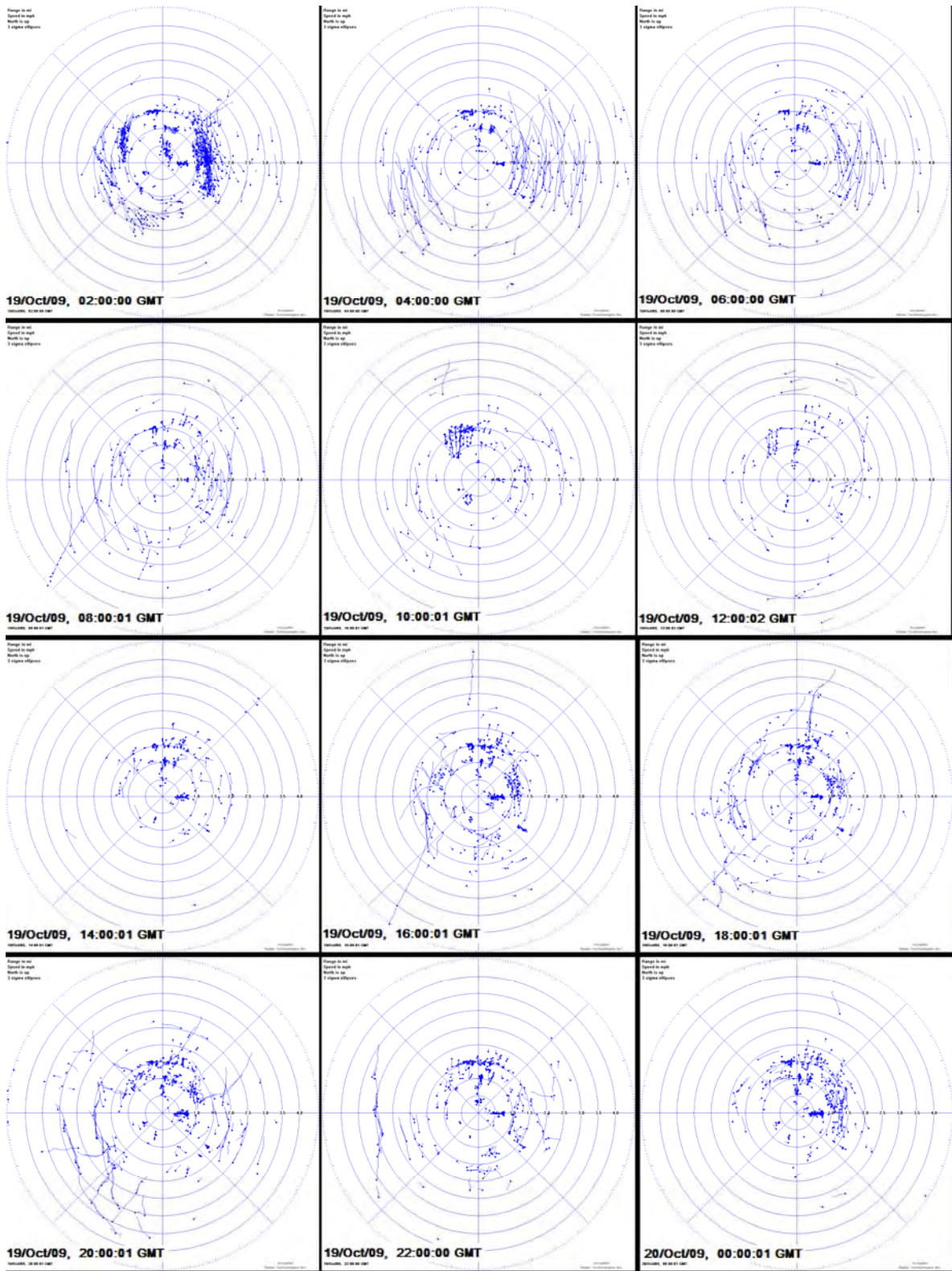

Figure 6-84. Two-hour track histories generated from the SEAR21 radar at SEA for October 19, 2009.

Figure 6-84 clearly demonstrates that target activity was seen by the radar every hour, day and night, for the full 24-hour period.

Conclusion

We have successfully demonstrated Performance Criterion PB9.2: A histogram plot for a five-day period and 12 track histories for a 24-hour period both demonstrated that the avian radar systems being evaluated by the IVAR project can detect and track targets at night as well as during the day.

6.3 DATA STREAMING

6.3.1 Quantitative Performance Criteria

6.3.1.1 Target Data Streaming Integrity Assured [PC1.1]

Objective

We designed Performance Criterion PC1.1, Target Data Streaming Integrity Assured, to assess the integrity of track records streamed from a DRP to an RDS over a WAN (the Internet). Ensuring the integrity of data transmitted across a network to remote users is critical to the operational use of avian radars.

To demonstrate this capability we proposed to identify a 1-hour segment of continuous plots and tracks data that had been recorded locally by the DRP and simultaneously streamed to a remote RDS. We further proposed to select the same 300 track update records from both the DRP and the RDS datasets and perform a field-to-field comparison of the 11 fields in both sets of records. We established as our success criterion less than 5% (165) errors from the 3300 (300x11) field-to-field comparisons.

Methods

We chose SEA as the preferred IVAR location for this demonstration because it has the longest period of continuous operation and data streaming of any of the IVAR study locations; it is also over 3300 km from ARTI, where the RDS is located, and thus would provide a good test of data streaming over large distances.

We developed the following procedure to demonstrate Criterion PC1.1:

- We located a continuous 1-hour dataset on one of the three SEA DRPs used in the IVAR studies.
- We transferred the plots and tracks files for that dataset from the DRP to ARTI for analysis.
- We extracted the corresponding dataset from the RDS database at ARTI.
- We loaded the two datasets separately into the TDV application and exported them to separate delimited text files.
- We imported the two delimited text files into separate worksheets in a Microsoft Excel® spreadsheet.
- We performed a field-to-field comparison of the 11 data fields from the same update records from the two worksheets containing the DRP and RDS records.

We selected one hour (20:00-21:00 UTC on 12 September 2009) of plots and tracks data selected from the SEAR2u rooftop radar at SEA. We had previously determined in the demonstration of SC2.1 (Section 6.3.1.6) that all track updates from 12 September 2009 existed in both the DRP and RDS datasets. We did not, therefore, need to identify 300 matching track updates. We instead used the full one-hour set of 2313 track updates records, which corresponded to a total of 25,443 field-by-field comparison. Table 6-24 lists the 11 fields compared between each of the 2313 track update records.

Table 6-24. The 11 fields used in the comparison of track update records. Excerpt is from the DRP dataset.

Date	Track ID	Update Time	Intensity	Range (m)	Azimuth (deg.)	Height(m)	Heading (deg.N)	Speed (m/s)	Latitude	Longitude
9/12/2009	177	59:47.6	1295	789.77	250.9	55.1	118.7	7.9	47.4394	-122.3104
9/12/2009	177	59:49.9	925	777.37	249.9	54.2	118.7	7.9	47.4393	-122.3102
9/12/2009	177	59:52.2	1188	765.62	248.9	53.4	118.6	7.9	47.4392	-122.31

We wrote the following formula in Microsoft Excel® to compare the 11 fields in the records from the DRP and RDS datasets:

$$=IF(From_DRP!A1=From_RDS!A1,0,1)$$

This comparison returned a ‘0’ if a match was found between corresponding fields in the ‘From_DRP’ and ‘From_RDS’ datasets, or a ‘1’ if a difference was found. We summed the results from the 25,443 comparisons to calculate the percentage of data errors between the two datasets.

Results

Our 5% success criterion corresponds to fewer than 1273 errors out of the 25,443 field-by-field comparisons of the 2313 track updates included in the DRP and RDS datasets from the SEAR2u radar at SEA. Table 6-25 is a summary of the results of those comparisons.

Table 6-25. Differences found in a field-by-field comparison of the DRP and the RDS datasets generated from the SEAR2u radar between 20:00-21:00 UTC on 12 September 2009 .

Datasets from SEAR2u at SEA	Number of Fields	Differences Found	Percent Data Errors (%)
RDS at ARTI	25,443	0	0
DRP at SEA	25,443		

As can be seen in Table 6-25, there were no errors (100% data integrity) in the 25,443 field-by-field comparisons from the two datasets used in this demonstration.

Conclusion

We have successfully demonstrated the ability to maintain a high degree (100%) of data integrity in streaming one hour of plots & tracks data from a DRP at SEA to an RDS located at ARTI more than 3300 km away.

6.3.1.2 Wired LAN Availability [PC3.1]

Objective

We designed Performance Criterion PC3.1, Wired LAN Availability, to assess the uptime of a wired network over 24 hours of continuous operation. Network availability is an important factor in providing target information to remote users who need it and, because of its significance, we expect to see high availability in this demonstration.

Performance Criterion PC3.1 calls for a test setup in which a radar installation, a DRP, and an RDS are located at a single site: ARTI. The components are to be interconnected by a wired LAN, and target information is to be processed by the DRP over a continuous, 24-hour period. This target information will be stored locally on the DRP and streamed to the RDS, thereby producing two separate datasets of the same plots and tracks data. A scan-wise comparison of the two datasets will be performed in order to identify any missing scans, ensuring that the (calculated) availability of the wired LAN is above 90%.

Methods

The prescribed test setup was established using an existing radar installation at ARTI. We connected a DRP to the radar, which was then connected to an RDS over a wired LAN. Target information was stored locally on the DRP and streamed to the RDS during a continuous, 24-hour period.

At the conclusion of the 24-hour period, we acquired the plots and tracks files from the DRP and extracted the corresponding dataset from the RDS. The datasets were loaded into the TDV application and exported to separate, delimited text files to facilitate analysis and comparison in Microsoft Excel®.

We created a Microsoft Excel® workbook that consisted of three worksheets: one entitled “From_RDS” which contained the dataset extracted from the RDS; a second entitled “From_DRP”, which contained the dataset from the plots and tracks files on the DRP; and a third entitled “Comparison”, which was used to perform the comparison between the DRP and RDS datasets.

This workbook layout can be seen in Figure 6-85:

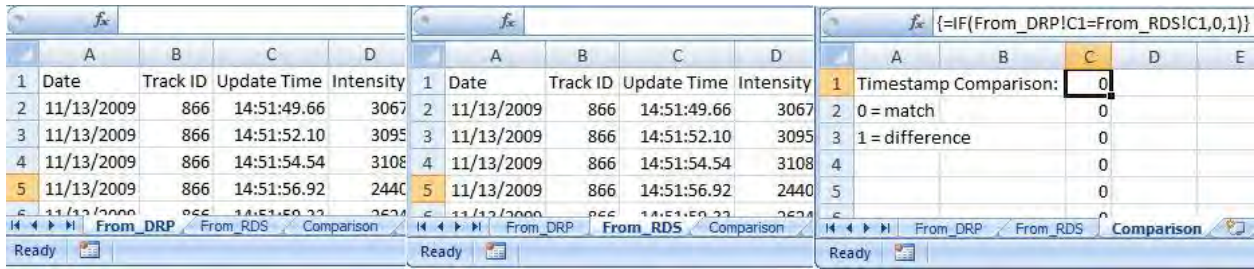

Figure 6-85. Microsoft Excel® workbook of track data from a radar that operated continuously at ARTI for 24 hours and recorded tracks locally on a DRP (left panel), streamed the same data over a wired LAN and stored them on an RDS (middle panel) and the scan-by-scan comparison of two datasets (right panel).

A formula was written employing simple logic to compare the update times between the datasets, as shown in Figure 6-85. If the update times were found to match in both the “From_DRP” and “From_RDS” datasets (i.e.: if the cells were identical), a 0 would appear in the corresponding cell in the “Comparison” worksheet. If a mismatch was found, a 1 would appear in the corresponding cell in the “Comparison” worksheet. A summation of the number of mismatches was then performed and used to calculate the availability of the wired LAN connection.

Results

A total of 328,366 track updates were produced in the 24-hour period of continuous radar data processing. As we previously discussed in the Performance Assessment section, the number of track updates depends on the amount of target activity seen by the radar.

Table 6-26 summarizes the findings of the comparison of update times in the DRP and RDS datasets:

Table 6-26. Results from comparison of the track data recorded locally on a DRP and the same data streamed to an RDS over a wired LAN for a 24-hour of period of continuous operations.

Dataset	Number of Updates	Differences Found	Calculated Availability (%)
From_DRP	328366	0	100
From_RDS	328366		

As anticipated, the calculated availability of the wired LAN in the test setup at ARTI was found to be 100%, well in excess of the 90% target threshold established as the success criterion for PC3.1.

Conclusion

We successfully demonstrated Performance Criterion PC3.1, Wired LAN Availability. The scan-wise comparison of update times between 24-hour DRP and RDS datasets yielded a calculated availability of 100%. This was above the target threshold of 90% availability. This result is important because it indicates that target track data can be streamed reliably across an

LAN within a facility to the operations and natural resources management personnel who need this information.

6.3.1.3 Target Data Organized into Database in Near-Real Time [PC4.1]

Objective

We designed Performance Criterion PC4.1, Target Data Organized Into Database In Near-Real Time, to assess the ability of an avian radar system to continuously organize its target data into a SQL database while relaying the same target data to a user, with little added time (latency) during the organization process. Successful demonstration of this criterion is vital to the two primary uses of avian radar data: organizing and storing the data in a database for historical playback and analysis, while redistributing these same data to real-time applications.

We defined the success criterion for PC4.1 as the ability to maintain a latency of <5 seconds (i.e., approximately 2 scan periods) for the data to flow from the DRP (where the live radar data are processed and then streamed) to the RDS (where the target data are organized and made accessible) to the TVW (where the target data are viewed).

Methods

We designed this demonstration to use the same test setup as PC3.1: A DRP processed a live radar feed at ARTI while streaming target information to an RDS over a wired LAN connection. We added a TVW to the wired LAN to display the target data as they are redistributed by the RDS. The TVW and DRP monitors were set side-by-side, and live target data could be seen on both displays: The DRP monitor was displaying the live radar data, while the TVW monitor was displaying the redistributed target data from the RDS. We installed Meinberg network time protocol (NTP) client software on the DRP and the TVW to ensure both processors were synchronized to the same time source.

We streamed live radar track data from the DRP to the RDS and from the RDS to the TVW for one hour. During this time we took screen captures of the TVW and DRP displays at 5-minute intervals for a total of 12 screen captures from each display. Because the TVW and DRP have separate displays (monitors), we had to take the two screen captures separately, although at approximately the same time. At the other end of the network, we displayed the data.

The screen captures were taken using the screen-capture tool available with both the DRP (Tracker) and TVW applications. This tool uses the processor system time as the filename for the image files it creates (e.g., 16.26.33.jpg). These filenames provided the reference times used in our analyses. The timestamps indicating when the target data were generated appear in the lower-left corner of the images created in this manner. Figure 6-86 is an example of a screen capture from the PC4.1 demonstration.

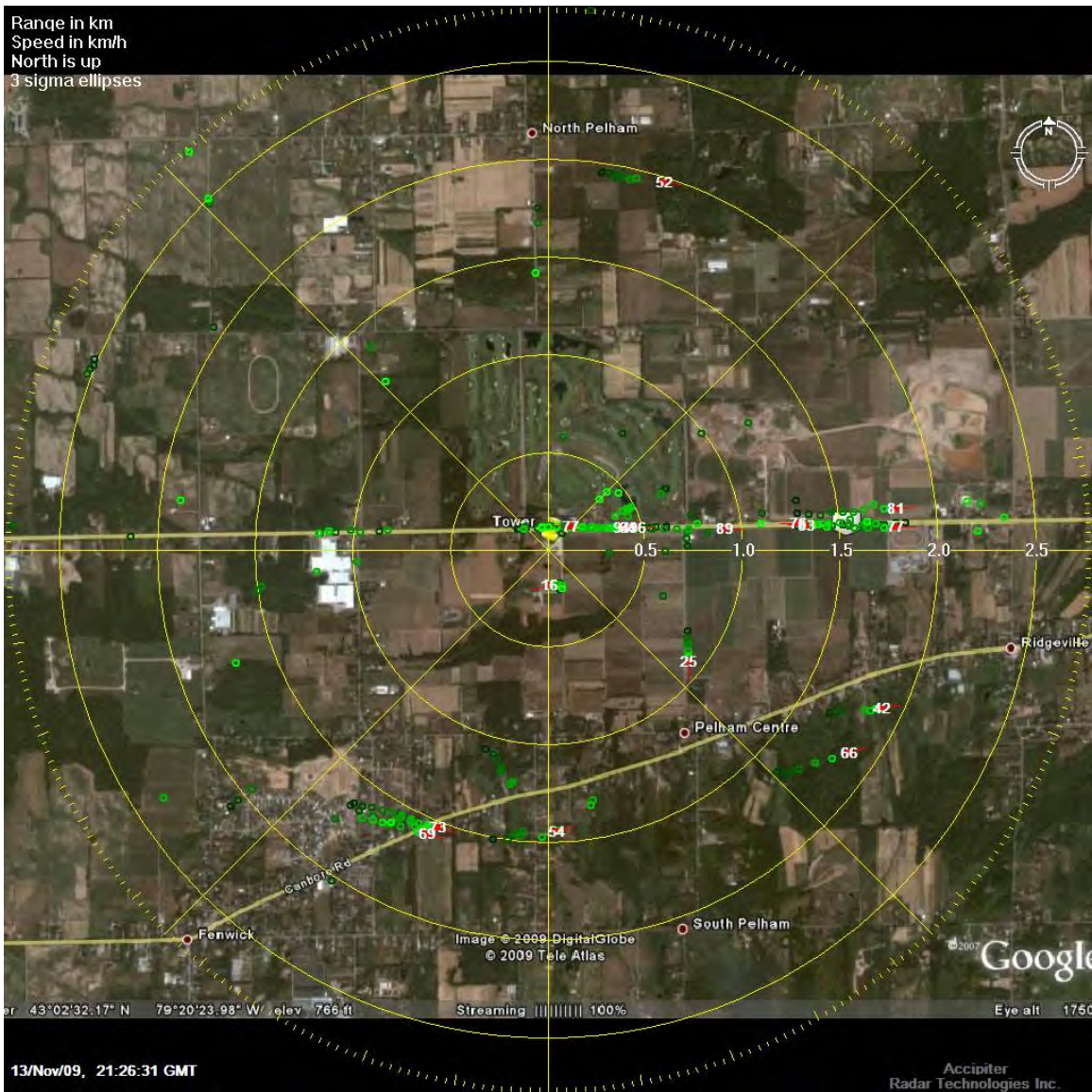

Figure 6-86. TVW screen capture of Sample #2 in the PC4.1 demonstration. The filename (16.26.33.jpg) of this image records the local reference time, 16:26:33 EST, (21:26:33 UTC); the timestamp in the lower left of the image records the time when the track data were captured by the DRP (21:26:31 UTC). The latency is the difference (0.02 seconds) between these two time values.

We extracted the target data timestamp from the TVW image and the reference time from the filename of the image file and recorded these in a Microsoft Excel® worksheet. We defined latency as the difference between the TVW system time (reference) obtained from the filename and the target data timestamp displayed on the TVW at the instant the screen capture was taken. We calculated the latency for each sample (from the TVW screen captures) as follows:

$$\text{Latency} = \text{TVW (reference) time (UTC)} - \text{Target data timestamp (UTC)}$$

All reference times were recorded in EST, but were converted to UTC by adding 5 hours to facilitate comparison with the corresponding target data timestamps (which were recorded as UTC).

A similar calculation was performed for the DRP screen captures to provide added perspective as to what near-real time means in terms of system performance. While the DRP screen captures were not essential to the calculation of latency, we took them to provide visual confirmation that the DRP was displaying the same target information as the TVW.

Results

We tabulated the reference time and target data timestamp for the screen captures that were taken every 5 minutes. We have referred to each pair of screen captures as a sample, as seen in Table 6-27:

Table 6-27. TVW and DRP screen capture timestamps, reference times, and computed latencies.

Sample #	Timestamps (hh:mm:ss) - UTC					
	DRP			TVW		
	Reference	Target Data	Difference	Reference	Target Data	Latency
1	21:21:03	21:20:59	0:00:04	21:21:03	21:20:59	0:00:04
2	21:26:33	21:26:31	0:00:02	21:26:33	21:26:31	0:00:02
3	21:31:06	21:31:04	0:00:02	21:31:06	21:31:04	0:00:02
4	21:36:03	21:36:02	0:00:01	21:36:03	21:36:02	0:00:01
5	21:41:06	21:41:04	0:00:02	21:41:06	21:41:04	0:00:02
6	21:46:10	21:46:08	0:00:02	21:46:10	21:46:08	0:00:02
7	21:51:05	21:51:03	0:00:02	21:51:05	21:51:03	0:00:02
8	21:56:05	21:56:03	0:00:02	21:56:05	21:56:03	0:00:02
9	22:01:07	22:01:05	0:00:02	22:01:07	22:01:05	0:00:02
10	22:06:04	22:06:02	0:00:02	22:06:04	22:06:02	0:00:02
11	22:11:04	22:11:02	0:00:02	22:11:04	22:11:02	0:00:02
12	22:16:04	22:16:02	0:00:02	22:16:04	22:16:02	0:00:02
		Mean	0:00:02		Mean	0:00:02

The range of calculated latencies from the TVW screen captures was between 1 and 4 seconds; the average latency was 2 seconds. Both of these values are less than the success criterion of 5 seconds (2 scan periods).

Real time target data are displayed on the DRP after they are processed. The target data timestamp in this display is free from latencies due to transmission, organization, and redistribution; however, it is only updated once every 2.5 seconds because of the scan period and refresh rate of the radar. This creates an apparent latency in the DRP and TVW displays that falls with the definition of real time (see Section 2.4.1) used in this study.

The time differences that we observed in the DRP screen captures in Table 6-27 match the calculated latencies in the TVW screen captures. This implies that the time added for streaming

and redistributing the target data was negligible in comparison to the time scale used for measurement (i.e., seconds).

Conclusion

We successfully demonstrated Performance Criterion PC4.1, Target Data Organized into Database in Near-Real Time: We found the system able to continuously organize its target data into a SQL database while relaying the same target data to a user, without adding significantly to the time delay (latency) during the organization process. The latencies we calculated from the TVW screen captures were less than the specified success criterion of 5 seconds. Although latencies of up to 4 seconds were observed in this demonstration, when we compared them to the differences seen on the DRP it is evident that the latency introduced by the RDS as it organizes and redistributes target data over the LAN is, in fact, negligible.

6.3.1.4 Near Real-Time Bird Awareness to Air OPS Personnel [PC5.1]

Objective

We designed Performance Criterion PB5.1 to assess the capability of the avian radars the IVAR project is evaluating to keep airport operations personnel informed of what the radar is seeing and tracking. The objective of this assessment is to determine the degree to which these radar systems improve the situational awareness of these personnel to bird movement and dynamics on and around the airport. Criterion PB5.1 further calls for the ratings airport personnel would give to the overall usefulness of this technology for their application, and that the metric should be a rating of 3 or higher on a scale of 1-5.

Methods

We developed a survey questionnaire (see Appendix E) and presented it to wildlife management personnel at SEA. This questionnaire asked them to assess how well the real-time display of data provided from the AR-2 and AR-1 avian radar systems improved situational awareness of the bird population in and around the airport. At SEA, near real-time radar detections of bird targets are available on laptop computers in operations vehicles. Connectivity to the radars is provided by wireless coverage of the airfield.

The questionnaire we developed asked air operations personnel to: 1) describe the technology used; 2) provide information on implementation of this technology in normal wildlife management activities; 3) assess the utility of the information in wildlife management; and 4) provide a rating of the technology.

We evaluated the ability of the Accipiter® avian radars to provide the SEA Wildlife Hazard Management Program personnel insight on avian radar capabilities and to determine how these systems might eventually be put to use by the nearly two-dozen airport operations personnel responsible for supporting this mandated effort under FAR 139.337 (FAA, 2009).

One Port of Seattle (Port) and one USDA Wildlife Services wildlife biologist spent a total of 10 hours at SEA evaluating the avian radars' operational capabilities using remote display technologies. Hazardous wildlife activity during this time was considered by the biologists to be much lower than the previous months, when flocks of several thousand European Starlings were being tracked by the radars daily. Other airport operations' personnel are aware of the radar's presence and the purpose on the airfield, but they do not currently make use of the real-time radar displays in their daily duties.

Description of Remote Display – As discussed elsewhere in this report (Section 4.5), there are three operational Accipiter® radar systems at SEA: two stationary AR-2 systems (SEAAR2u & SEAAR2l) on top of the Operations Building, and one AR-1 (SEAAR1m) trailer-mounted radar located on the infield of airport. These systems were installed and implemented at SEA to provide what was understood to be a reasonable level of observational coverage for detecting most bird activity on and near the airport (**Figure 6-87**). The ground-based AR-1 was the primary radar used for this survey because its area of coverage best matched the lower altitudes where a bulk of the wildlife control monitoring and actions were typically conducted.



Figure 6-87. Locations of three avian radar systems operating at SEA. The AR-2 is comprised of two radars.

In December 2009, the biologists evaluated two of the three software programs currently offered by ARTI to display radar information in this survey. We established remote display capabilities inside a SEA Airport Operations vehicle with the SEAAR11 radar using a center-console

mounted laptop computer (**Figure 6-88**), an external wireless USB cell phone card, virtual private network (VPN) software to gain access to the Port's computer network, and Virtual Network Computing (VNC) software to view the display of the DRP. In addition, they used the Google Earth Client (GEC) software connected via the internet to the Enterprise server at the ARTI facility in Ontario, Canada to view the same output from the SEAAR1m radar. The wildlife biologists did not use the ARTI TVW software at SEA because they were in the process of testing the automated "sense and alert" feature of this software and could not use its remote display as part of this evaluation.



Figure 6-88. Remote access to the Digital Radar Processor (DRP) software operating the AR-11 computer provided the wildlife biologists with radar-generated plot and track information on suspected bird targets.

Results

Wildlife Hazard Management Implementation – To better understand how to best implement the available remote display technologies, the evaluators first investigated three topics of interest (see methods described in Appendix E): (1) Early Notification, (2) Observational Confirmation, and (3) Display Latency. The latter was of particular importance because latency was different for trials that tested the scenario of a hypothetical bird landing or taking off, compared to “fly passing” activity where the target was in constant motion.

Early Notification – The two biologists expended approximately 8 of the total 10 hours of effort over a three-day period to determine how the DRP improves situational awareness from the perspective of providing early notification of hazardous wildlife activity. They noted that much of the bird activity on the airfield during this period was smaller non-hazardous birds such as sparrows. In one of a total of ten occurrences, the observers were confident they were responding to the same bird activity first detected by the radar (several crows). Vehicle response time was indicated as a complicating factor in confirming the presence of the bird target seen earlier on the display.

Observational Confirmation – The two biologists spent 90 minutes in observational confirmation trials. Radar tracks displayed on the remote DRP were compared with known bird activity first recognized by visual observation from the vehicle supporting the remote display. There were two instances where a flock of 300-400 starlings was seen and the AR-1 provided track data to the DRP remote display.

Display Latency Determination – Because the tracking algorithm requires several scan periods before a new track is elevated to “confirmed” status, quantifying this latency was important for understanding its impact on near real-time situational awareness. The biologists spent 30 minutes determining display latency differences between the GEC and the DRP (Appendix E, Table E-1). They conducted multiple trails to determine the amount of time that had passed from when a target became mobile to when it was actually tracked and visible on the display. This kind of activity emulates the typical scenario of a bird taking off from the airfield. For this situation, and for those when a target became stationary (e.g., landed), the direct DRP display was consistently twice as fast at 8-10 seconds compared to the 17-22 s of the GEC. A similar relationship was noted for the fly passing trials: the DRP display was updated every 2.5 seconds, half the refresh interval of the GEC display. The latency result was equivalent to the associated update rate (screen refresh rate) for both the DRP and the GEC.

Utility for Airport Wildlife Hazard Management - The one-hour play back feature of the GEC allowed the two biologists to do a quick review of bird activity on the airfield and then proceed to that location where the greatest amount of bird movement had recently been tracked. After repositioning to the area of higher bird use, we employed the DRP to assist the human observers, who also used binoculars on occasion, to better monitor bird presence.

Technology Rating – The biologists assigned numerical ratings based on the overall usefulness of the DRP to a person tasked with wildlife hazard management responsibilities on an active airfield. The mean rating for all 10 categories was 3.4, where 3 is good and 4 is very good. Very good ratings were given to “Ease of Implementation”, “Demonstrated Validity of Display” and “Reliability” because the display was readily accessible from the vehicle, it provided a general sense of the low hazard level that had been witnessed during its use, and it proved reliable during each of the seven times it was used to gather data for the survey assessment, respectively. The system was also able to detect and track the several flocks of starlings, the most hazardous concentration of bird activity seen during this evaluation. A good rating was assigned to “Ease of Use”, “Timeliness”, and “General Utility”. The overall rating of the display itself was more varied, ranging from very good for “Display Information Content”, and good for “Display Update Rate” to fair for “Display Format”. The higher rating for content was due to the DRP’s option to display plots (suspected targets) as well as tracks (confirmed targets). Format ranked as fair because screen navigation, particularly zooming in to a desired location was cumbersome. “Improved Situational Awareness”, which was at the center of the survey instrument, ranked

very good because the system was sampling bird movements over the full 72 hr evaluation period of December 15-17, 2009. Item 7, Appendix E provides a more detailed explanation regarding how values were assigned.

Since August 2007, only wildlife biologists had daily access to the radar historical and live radar data. They used this information to help answer questions related to identifying areas on the airfield with higher than normal level of birds use, and to understand how birds were using a variety of habitat types on Port property. The recent maturation of this technology now allows for viewing the near real-time radar detections in conjunction with ongoing wildlife monitoring and control activities. The survey we conducted was an effective method of obtaining information on the practical utility of avian radar technologies for the wildlife biologists at SEA.

The biologists generally preferred the DRP display over that of the GEC for remotely viewing the track data, even though the GEC displayed tracks from all three radars simultaneously. The advantage of the DRP program, is that it could display both plots (detections) and tracks simultaneously. The desire to see all radar detections stemmed from the biologists' prior experience with raptors, a group that typically circles tightly and slowly when soaring and can be more difficult to track with the standard settings of the tracking algorithm. The biologists used the GEC software on an occasional basis because it had the option of rapidly playing back the preceding hour of activity for viewing. Unlike the DRP, establishing a GEC display on the remote PC mounted in an operator's vehicle did not require the VPN and VNC connections to access the SEAAR1m radar on the Port's internal network. Both remote displays were found to be reliable and reasonably supported by the external USB wireless connection.

The biologists who implemented the real-time remote display capabilities in an airport operations vehicle were interested in testing differences in latency between the displays to better understand system capabilities and potential uses to airport operators. For the trials designed to emulate the taking off/landing behavior of a bird and to monitor a constantly moving bird, the results showed the latency was consistently twice as long for the GEC display compared to the DRP (Appendix E, Table E-1). Consequently, when near real-time bird movement data was needed, the biologists found the DRP to be the remote display of choice.

For radar applications where early notification of a hazardous situation is critical, the shorter latency period would logically be preferred (see Section 6.4.1.2, Near-real-time integration for common operational picture). For example, given the 2.5 s latency time (refresh rate) of the DRP display, birds moving at 10 to 20 m/s ("fly passing") would require the remote observer on the airfield to look ahead roughly 40 m from where the DRP display indicated the target was in order to visually locate the tracked bird(s). That distance would double for the GEC display tracking the same birds. Moreover, birds that are just taking flight off from the airfield would travel at least 275 m in the 17 s it takes the radar to detect, confirm, transmit and display the target on the remote computer using the GEC. We should note, however, that the GEC sampling rate was set to the default value in these studies. It can, and obviously should, be increased to minimize latency for these types of applications.

The performance assessment values assigned to each of 10 categories on the questionnaire varied slightly. The average score ranked better than a good rating for a radar system that provided remote monitoring capabilities, and a four for overall situational awareness. One aspect of the radar technology that they did not include in this rating, but that would have resulted in a higher

score, is the fact that the radars continued to monitor bird activity even after our evaluations had terminated at the end of each day.

Experimental use of the Accipiter® sense and alert system at SEA has determined that this function provides remote alerts in the forms of an audible alarm or an email notification (Osmek et al., 2009). This function was not evaluated at the current study because of the complexity of assigning criteria to substantial areas of the airfield in a manner where only hazardous birds trigger an alert message and not smaller birds that are not typically considered hazardous or worthy of performing mitigation measures.

One viewpoint expressed during this survey that relates to another aspect of getting information about birds to the air operations personnel is the need for a system alarm to notify of failing system health. This would be similar to the FAA receiving an alarm when their Navigational Aid Systems (NAVAIDS) malfunction or are somehow compromised.

Before this evaluation of real-time remote radar displays, SEA had primarily analyzed archived radar data to determine historic temporal and spatial trends of starling activity and for assessing the potential attractiveness of new airport stormwater detention ponds. From an airport operator's perspective, this radar technology currently provides data that directly supports the monitoring requirements needed to perform the SEA ongoing Wildlife Hazard Assessment, a stated goal in the SEA Wildlife Hazard Management Plan (WHMP), which is a part of the airport's FAA Certification Manual. Moreover, enhanced observational coverage, especially at night, provided better real-time situational awareness of airport bird use at distances far above the normal abilities of the observer (> 10 km).

We were unable to demonstrate the ability of the wildlife biologists to respond to bird presence more rapidly than they normally would have without the midfield AR-1 radar because of the lower than normal hazardous wildlife activity when the study was conducted. However, one unexpected benefit of the live radar display was the ability to track a flock of starlings across and then off the opposite end of the airfield after they had been harassed – a result that saved the biologist time by negating the need to pursue the birds further on foot or in the vehicle (Item 7, Appendix E).

Display latency was a critical component in the selection of the primary remote display used to evaluate near real-time situational awareness. A system delay of 10 seconds or more can not only affect the position agreement between the bird's true location and what is displayed by the radar, but it also affects hazard level assessment with respect to the track's proximity to an aircraft's flight path. Conversely, the importance of latency diminishes as the need for accurate real-time geographic position data decreases, as would be the case for long-term monitoring or when post processing archived data.

Whereas the ramifications of latency matters little to those interested in analyzing archived radar information, it is important when discussing situational awareness and considering how to expand the utility of avian radar data to the broadest range of users, especially those responding to a sense and alert system where communicating a precise location might be expected.

The criteria used to determine when an end-user is alerted to a situation is a question of assessing aviation bird hazards based on a variety of factors such as the species of bird, flock size and location, as well as the birds' movement patterns with respect to critical airspace. Currently, hazard level determination is something only the human observer can assess, meaning airport

operations personnel or their contractors will continue to play an important role in the effective use of bird radar system deployed at airports. Further, the survey results also identified the need for airport radar systems to provide alarms when system health degrades and their ability to track objects with the same level of efficacy is compromised.

Conclusions

Performance Criterion PB5.1 has been demonstrated by soliciting feedback from two wildlife biologists at SEA who rated the avian radar system operating there as better than good (3.4 on a scale of 1-5, Appendix E). Although the evaluation period lasted only 10 hours, the biologists' remarks in the survey instrument indicated a general improvement in real-time situational awareness, most noticeably related to the overall increase in the number of likely bird tracks that were repeatedly seen near the airport compared to what they normally saw while driving the airfield and searching for birds.

6.3.1.5 AUTOMATIC EARLY WARNING OF DEVELOPING BIRD HAZARDS [PC6.1]

Objective

We designed Performance Criterion PC6.1, Automatic Early Warning of Developing Bird Hazards, to demonstrate the capability of a TVW running in near-real time to issue automatic early warning of developing bird hazards derived from the behavior of the real-time tracks. This demonstration builds on Performance Criterion PC4.1, in that a DRP, a TVW, and a RDS are connected to the same LAN.

In this demonstration we used plots and tracks files containing an event that occurred on 15 January 2008 at NASWI. This near-miss event involved a flock²³ of a thousand or more Black-bellied Plovers that flew directly down Runway 25, narrowly missing several aircraft that were on approach for landing. The event was recorded by the WIAR1 radar and also observed visually by BASH personnel who were at the radar trailer at the time.

Our objective in the design of this test was to demonstrate that had an automatic alarm been set for this type of event, an unattended radar could have warned the appropriate personnel in time for them to respond. In order to satisfy Performance Criterion PC6.1, the email alert had to be transmitted at least 1 minute prior to the designated event – enough time to alert control tower or wildlife management personnel to the developing hazard so they could take appropriate actions.

Methods

We implemented the prescribed test layout for demonstration of PC6.1 as follows:

- A DRP and an RDS were connected to the same LAN.
- Plots and tracks files containing the near-miss event from 15 January 2008 at NASWI were loaded into the DRP application.
- Target data from the near-miss event were streamed from the DRP to the RDS.

²³ As can be seen in **Figure 6-92** and following, the flock of Black-bellied Plovers broke up into smaller aggregations of birds that were then tracked individually by the radar. In the discussions that follow we use the singular, “flock”, because both the visual observers and the behavior of the birds confirmed they were all part of a large flock.

- The TVW application was run on a workstation connected to the same LAN as the DRP and RDS and configured to access target data from the RDS in near-real time (as demonstrated in PC4.1, Section 6.3.1.3).
- All three components (DRP, RDS, and TVW) were synchronized to the same NTP time source.

We took side-by-side screen captures of the DRP and TVW displays (as we did in PC4.1) to ensure that they were displaying the same target information with minimal latency between the displays.

For this test we defined an alarm region in the TVW application having the geometry shown in Figure 6-89. We assigned to the region logic that would ensure that targets with the specified speed, heading, and track count criteria entering the alarm region would trigger an automated warning. We set the following actions to occur each time an alarm was triggered:

- Write the target data timestamp to an “alarm activity” log, along with the alarm region name and alarm state.
- Play an alarm sound file.
- Display in the alarm status pane a message with the alarm region name and alarm state (e.g., Runway Corridor TRIGGERED).
- Invoke the Accipiter® Alarm Emailer client to automatically send an email to all specified recipients.



Figure 6-89. TVW alarm region (tan lines) for 15 January 2008 NASWI near-miss event.

The subject of the email was the date and time of the event (as read from the target data timestamp in UTC), and the body of the email was the alarm region name and alarm state. The time the email was sent was contained within the email header. Figure 6-90 displays the TVW alarm status pane and Accipiter® Alarm Emailer.

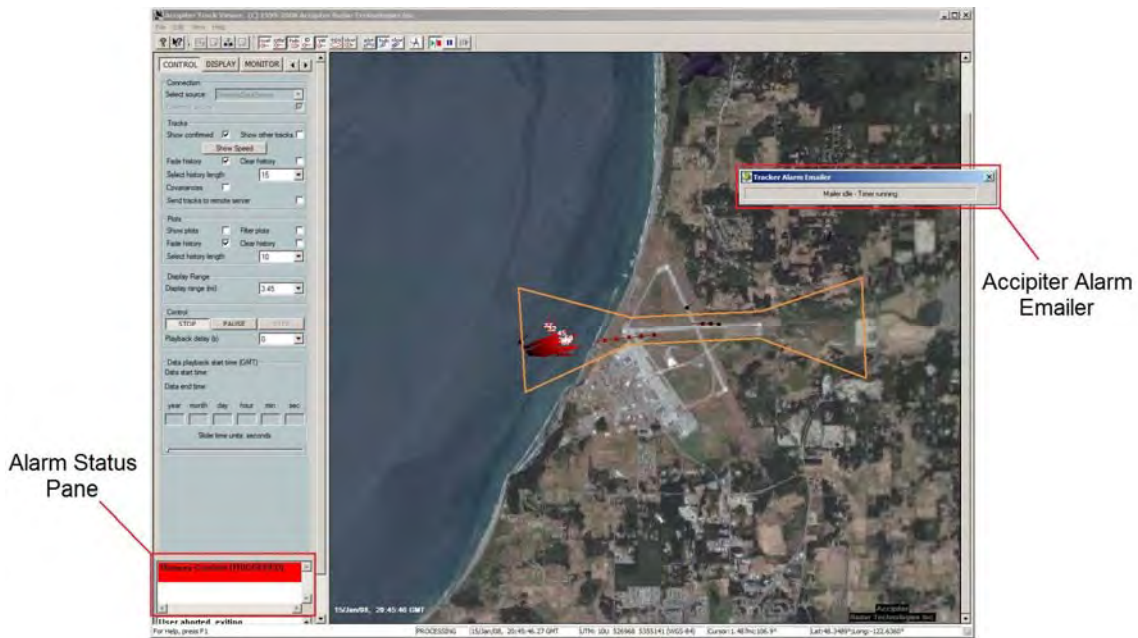

Figure 6-90. Alarm status pane and Accipiter® Alarm Emailer.

We defined the climax of the bird hazard event as the time at which the flock reached the west end of Runway 25. The email alert would have to be sent at least one minute before the flock reached that point.

Results

We took screen captures of the TVW and DRP displays as the event was replayed. The WIAR1 radar began tracking the flock of Black-bellied Plovers at 20:44:24 GMT – see target data timestamp in the TVW screen capture depicted in Figure 6-91.

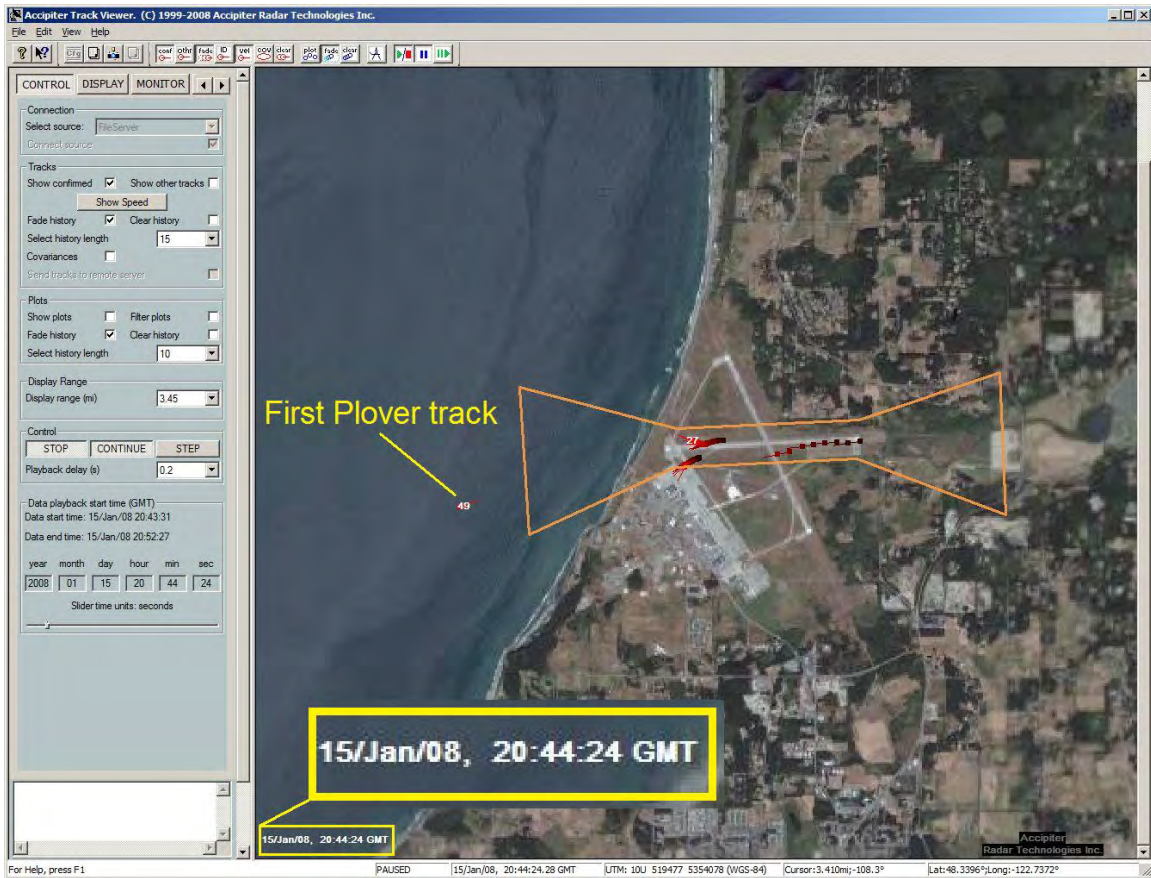

Figure 6-91. TVW screen capture of the formation of the first black-bellied plover tracks at NASWI on 15 January 2008 at 20:44:24 GMT.

The physical extent of the flock began to grow and fragment, forming several confirmed targets as it moved towards the alarm region. The flock satisfied the alarm logic as it entered the region and successfully triggered the alarm at 20:45:02 GMT. We took a screen capture of the TVW at this time, as show in Figure 6-92.



Figure 6-92. Alarm triggered as a flock of black-bellied plovers enters the alarm region set for NASWI on 25 January 2008.

All specified alarm actions were executed automatically as the alarm was triggered: An entry was made in the alarm activity log, sound playback began, the alarm status pane displayed the alarm region name and state (see Figure 6-92), and the email alert was sent.

The automatic entry made in the alarm log is shown below:

ALARM Info: 20:45:02, Tuesday, Jan 15, 2008.
Runway Corridor (TRIGGERED).

A screen capture of the email alert, sent by the Accipiter® Alarm Emitter, is shown in Figure 6-93:

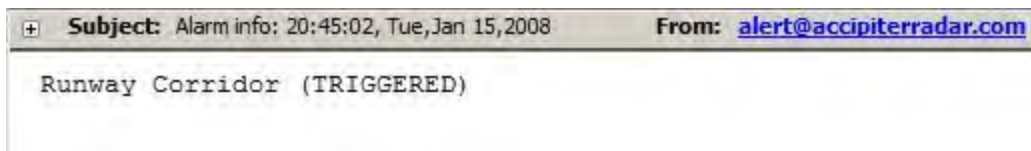

Figure 6-93. Email alert from Accipiter® Alarm Emitter.

The flock continued to move eastward, reaching the west end of Runway 25 shortly after 20:46:24 GMT. This was more than 82 seconds after the email alert was sent, and 120 seconds after the first track was formed of the flock of plovers by the DRP. The screen capture of the TVW display as the birds crossed the western end of the runway is shown in Figure 6-94:

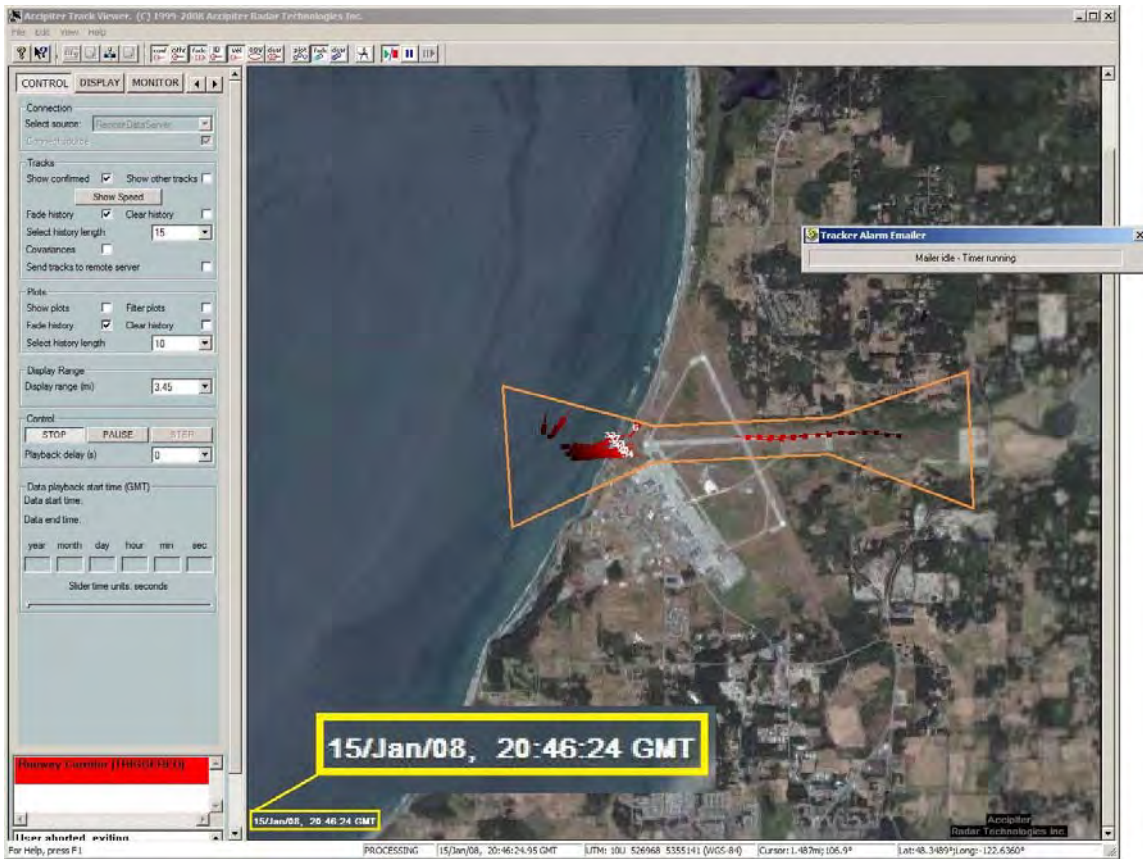

Figure 6-94. Screen capture of TVW display as the flock of black-bellied plovers reaches the west end of Runway 25 at NASWI on 25 January 2008.

The bird hazard condition persisted for another 2 full minutes as the flock passed over the entire length of the runway, gradually dispersing to either side. The alarm was de-triggered at 20:48:30 GMT, as the remaining targets within the alarm region no longer satisfied the alarm logic. A screen capture of the TVW display at the height of the bird hazard condition at 20:47:34 GMT (Figure 6-95) illustrates the density of the flock as it passed over the runway.

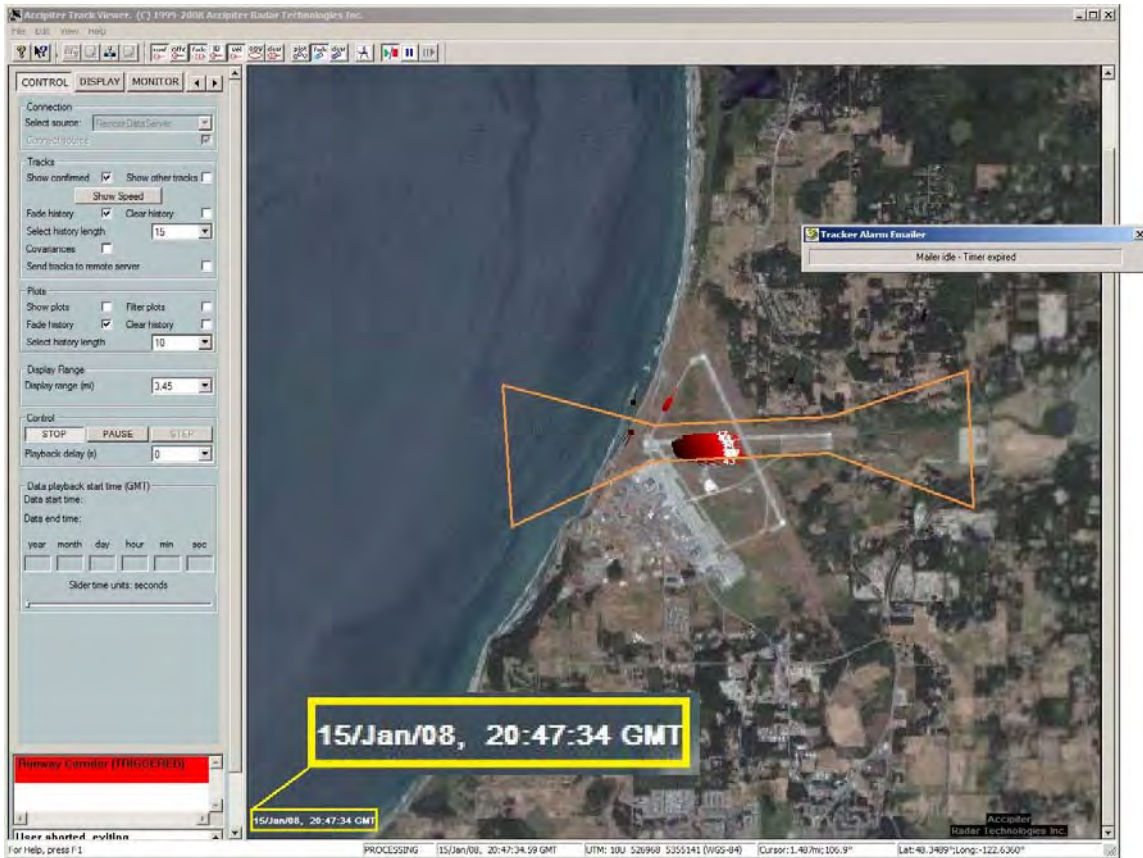

Figure 6-95. Screen capture of the flock of black-bellied plovers as it passed farther down Runway 25 at NASWI on 15 January 2008.

An expansion of this technique for monitoring developing hazards and an analysis of near collisions is presented by Klope et al. (2009) based on these data and data from MCASCP.

Conclusion

Performance Criterion PC6.1 was successfully demonstrated: An email alert was transmitted over 1 minute before a bird hazard condition reached its climax. In this demonstration, the email was sent as a flock of Black-bellied Plover entered the alarm region surrounding runway 25 at NASWI. This was more than 82 seconds before the flock reached the western end of runway 25.

6.3.1.6 Wired WAN (Internet) Network Availability [SC2.1]

Objective

We designed Performance Criterion SC2.1, Wired WAN (Internet) Network Availability, to demonstrate that availability between a DRP and an RDS can be maintained over a wired wide area network (WAN) – in this case, the Internet. With remote users desiring access to real-time bird information, network availability is an important consideration in the operation of avian radar systems. Successful demonstration of this task will establish that Internet uptime is sufficiently high, ensuring target data are inexpensively available to remote users who need it.

We chose as a success demonstration of this capability the criterion that the wired WAN must be available at least 50% of the time over a 24 hours period of continuous. Our analysis of this criterion involved a pair-wise comparison of the scan times as recorded locally by the DRP versus the scan times of the records that were streamed remotely to the RDS. If network transmission is lost or corrupted during this period, some records will be lost (or discarded) at the RDS end, and this will result in a discontinuity in the two sets of scan times (Update Time values). With a scan period of 2.5 seconds, the DRP should generate, record locally, and stream remotely a total of 34,560 records over a 24 hour period - assuming at least one target is being tracked throughout that period. Thus the success criterion of 50% availability corresponds to more than 17,280 records being transmitted to the RDS without error over that period.

Methods

In order to demonstrate performance criterion SC2.1, the following procedure was developed:

- A continuous 24-hour dataset was located on one of the DRPs used in the IVAR studies.
- The plots and tracks files for that dataset were transferred from that DRP for analysis.
- The corresponding dataset was extracted from the RDS database.
- The two datasets were loaded separately into the TDV application and exported to individual delimited text files.
- The delimited text files were imported into a Microsoft Excel® spreadsheet, where a full comparison between scan times from the two datasets was performed.

We chose SEA for the SC2.1 demonstration because the avian radars there have the longest period of continuous operation and data streaming of any of the IVAR study locations. SEA has the further advantage that it is over 3300 km from the RDS at ARTI, and thus a good test of the Internet availability over longer distances.

We selected a 24-hour plots and tracks dataset from the stationary SEAAR11 rooftop radar at SEA recorded 12 September 2009 for the test. The SEA data files were transferred to ARTI via a scheduled secure-copy (SCP) file transfer. We replayed the dataset in the TVW application to ensure continuity. From this evaluation we determined that weather conditions were favorable at SEA on the selected date, ensuring that sufficient activity (i.e., bird targets) would be seen by the radar.

Next we extracted from the RDS each record that had been streamed from the SEAAR11 to the RDS at ARTI on 12 September 2009 and wrote out those records from the database into the plots and tracks file format. We did this so that the two datasets would have identical formats for the scan-wise comparison.

We loaded the two datasets separately into the TDV application, as illustrated for one dataset in **Figure 6-96**.

TrackDataViewer v2.7 (C) Accipiter Radar Technologies Inc. 2008

File Edit Format Detailed Views Help

Date	Track ID	Start Time	Duration (s)	Number of Updates	Start Range (m)	Start Azimuth (deg.)	Intensity	Start Heading (deg.)	Start Speed (m/s)	Start Height (m)	Start Latitude	Start Longitude
09/12/09	888	00:00:01.654	23.08	6	837.09	308.7	1300	177.3	11.3	58.4	47.4464	-122.3092
09/12/09	147	00:00:32.45	18.46	5	2134.50	337.1	669	160.3	12.4	148.9	47.4594	-122.3115
09/12/09	396	00:01:16.420	12.00	2	8621.42	64.7	909	138.0	28.0	601.4	47.4748	-122.1971
09/12/09	652	00:01:18.779	20.77	5	772.58	230.9	1253	173.9	8.4	53.9	47.4373	-122.3084
09/12/09	947	00:02:14.841	25.38	8	2097.08	332.2	928	89.4	6.0	146.3	47.4584	-122.3135
09/12/09	88	00:02:21.795	20.77	5	2083.77	328.5	675	69.9	10.1	145.4	47.4577	-122.3149
09/12/09	423	00:02:52.107	23.08	6	956.89	217.3	974	223.0	3.3	66.7	47.4349	-122.3082
09/12/09	841	00:04:09.29	20.77	5	1261.85	208.7	971	268.1	3.8	88.0	47.4317	-122.3085
09/12/09	64	00:04:15.998	23.08	7	1370.21	339.3	1248	105.1	5.3	95.6	47.4532	-122.3069
09/12/09	377	00:04:41.701	18.46	5	998.01	92.4	1829	281.9	11.0	69.6	47.4413	-122.2873
09/12/09	0	00:10:33.873	18.46	4	1547.52	4.1	1074	5.6	24.6	107.9	47.4556	-122.2990
09/12/09	311	00:11:57.920	24.00	4	1763.99	40.4	1045	55.3	17.1	123.0	47.4538	-122.2853
09/12/09	544	00:11:57.920	26.40	8	1633.31	340.7	1433	262.9	9.1	113.9	47.4556	-122.3077
09/12/09	478	00:12:02.623	18.46	4	1836.15	27.6	508	17.1	16.4	128.1	47.4563	-122.2892
09/12/09	763	00:12:09.576	25.38	8	2544.91	1.1	970	351.9	11.8	177.5	47.4646	-122.2999
09/12/09	725	00:12:39.998	16.80	4	7416.59	97.9	1150	176.5	14.9	517.4	47.4325	-122.2031
09/12/09	902	00:12:42.341	25.38	8	1434.51	334.2	1507	195.2	7.7	100.1	47.4533	-122.3088
09/12/09	900	00:12:42.341	50.77	19	1436.10	321.7	1173	184.7	7.9	100.2	47.4518	-122.3123
09/12/09	560	00:13:00.982	34.62	12	1240.41	328.8	1448	185.3	11.6	86.5	47.4512	-122.3090
09/12/09	565	00:13:03.326	9.23	1	7536.36	105.8	1196	181.6	25.0	525.7	47.4232	-122.2044
09/12/09	994	00:13:26.638	20.77	5	1165.55	327.1	902	172.9	9.4	81.3	47.4505	-122.3089
09/12/09	444	00:13:42.982	20.77	6	861.16	309.7	1316	179.5	11.2	60.1	47.4466	-122.3093
09/12/09	23	00:14:03.951	18.46	5	822.17	307.7	1579	175.4	12.0	57.4	47.4462	-122.3091
09/12/09	135	00:14:08.638	23.08	7	2465.87	150.9	786	103.2	8.1	172.0	47.4223	-122.2846
09/12/09	784	00:14:36.591	20.77	6	1317.75	270.3	1251	183.0	23.3	91.9	47.4418	-122.3180
09/12/09	895	00:14:43.623	9.23	1	10595.32	138.6	1013	47.4	27.0	739.1	47.3702	-122.2078
09/12/09	857	00:15:13.966	20.77	6	839.74	254.2	1634	356.1	17.9	58.6	47.4396	-122.3112
09/12/09	286	00:16:12.326	18.46	4	951.12	223.7	1408	162.8	22.9	66.3	47.4355	-122.3092
09/12/09	505	00:16:19.263	41.54	15	987.01	344.6	1537	157.5	5.3	68.9	47.4503	-122.3040
09/12/09	772	00:16:30.998	18.46	5	938.14	357.5	1601	94.0	18.1	65.4	47.4501	-122.3010
09/12/09	142	00:16:37.967	25.38	7	903.90	354.2	1846	230.5	9.3	63.0	47.4498	-122.3017
09/12/09	176	00:17:12.936	18.46	4	910.20	354.1	2028	78.3	5.7	63.5	47.4498	-122.3018
09/12/09	310	00:19:37.687	18.46	4	2790.98	332.7	485	3.7	19.4	194.7	47.4640	-122.3175
09/12/09	737	00:19:49.343	20.77	6	1501.01	3.3	1753	4.2	21.4	104.7	47.4552	-122.2994
09/12/09	824	00:19:49.343	20.77	6	1550.06	350.2	1612	357.3	22.1	108.1	47.4554	-122.3040
09/12/09	625	00:21:36.703	18.46	4	1234.85	9.4	782	185.2	21.8	86.1	47.4527	-122.2978
09/12/09	622	00:21:34.359	18.46	4	1241.96	349.4	1236	138.3	23.8	86.6	47.4527	-122.3035
09/12/09	867	00:22:49.16	18.46	5	2621.54	2.0	611	2.9	17.5	182.9	47.4653	-122.2993
09/12/09	441	00:22:56.63	52.80	19	2521.32	345.5	596	93.1	11.0	175.9	47.4637	-122.3089
09/12/09	705	00:23:03.00	39.23	14	2504.78	353.8	700	98.6	10.2	174.7	47.4641	-122.3041
09/12/09	702	00:23:03.00	43.85	16	2507.26	333.1	783	76.2	10.4	174.9	47.4618	-122.3155
09/12/09	588	00:23:03.00	34.62	12	2505.13	341.2	825	92.4	8.2	174.7	47.4630	-122.3112
09/12/09	721	00:23:54.376	18.46	4	1784.81	329.2	550	49.4	5.3	124.5	47.4555	-122.3126
09/12/09	684	00:25:34.626	41.54	14	2506.98	347.0	606	87.9	13.6	174.9	47.4637	-122.3080
09/12/09	383	00:27:12.643	26.40	8	1450.49	3.9	1797	3.1	19.4	101.2	47.4547	-122.2992
09/12/09	382	00:27:10.299	20.77	6	1451.85	349.8	1635	350.0	19.9	101.3	47.4546	-122.3039

Ready NUM

Figure 6-96. An example from a dataset loaded into TDV application.

Using the “Save As” function of the TDV application, we then exported each of the datasets to a delimited text file format. An excerpt from one of these datasets is shown in Table 6-28:

Table 6-28. An example of data exported from TDV to a delimited text file format.

Date	Track ID	Update Time	Intensity	Range (m)	Azimuth (deg.)	Height (m)	Heading (deg.N)	Speed (m/s)	Latitude	Longitude	UTM Zone	UTM Northing	UTM Easting
9/12/2009	888	00:00:03.6	1300	837.09	308.7	58.4	177.3	11.3	47.4464	-122.3092	10T	5255005	552081
9/12/2009	888	00:00:06.0	1445	821.59	307.4	57.3	177.4	11	47.4462	-122.3092	10T	5254981	552083
...

Finally, we imported the two delimited text files into separate worksheets in a Microsoft Excel® workbook, which we used to compare the Update Times of the two datasets in a cell-wise manner according to the following formula:

$$=IF(RDS!C1=DRP!C1,0,1)$$

Where *RDS!* refers to the dataset from the RDS and *DRP!* refers to the dataset extracted from the DRP. We wrote this formula to output a ‘0’ if a match was found between corresponding cells or a ‘1’ if corresponding cells were not identical. Figure 6-97 is an example of this comparison:

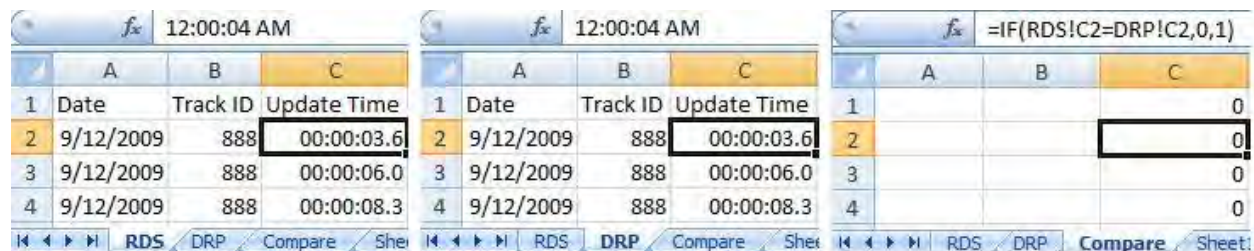

Figure 6-97. Comparison of the Update Times from the RDS dataset (left pane) with those from the DRP dataset (middle pane). The right pane indicates if the two Update Time values were the same (‘0’) or different (‘1’).

We then summed the number of records where the Update Time values were different (‘1’) and used this value to calculate the wired WAN network availability.

Results

There were 41,196 records (“updates”) in the 12 September 2009 dataset transferred from the SEAR11 DRP. Thus, our success criterion of 50% network availability was equivalent to fewer than 20,598 Update Time values that were different between the DRP and RDS datasets. Table 6-29 summarizes the actual number of different Update Time values.

Table 6-29. Differences found between the Update Time values of the local DRP dataset and those of the remote RDS dataset from the AR2-1 avian radar at Seattle-Tacoma International Airport on 12 September 2009.

Dataset (2009.09.12)	Number of Updates	Differences Found	Availability (%)
RDS at ARTI	41,196	0	100
SEAAR11 DRP at SEA	41,196		

The Updates Times from the two datasets of 41,196 records each were identical, indicating 100% (calculated) network availability.

Conclusion

Using the methods described above, we successfully demonstrated 100% network availability for a wired WAN (the Internet) over a 24-hour period, a level of availability much higher than the success criterion of 50%. A wired WAN (the internet) provides the avenue by which all remote units (DRP, RDS, TVW, etc.) of the system are connected. Reliability of this network is essential for real-time monitoring of avian hazards and transferring data through the RDS.

6.3.1.7 Wireless LAN Availability [SC4.1]

Objective

We designed Performance Criterion SC4.1 to assess the wireless connection uptime at two remote IVAR study locations that continuously stream target data back to an RDS at ARTI. We proposed to do this through a pair-wise comparison of the scan times as generated over a 24-hour period by the DRP and those extracted for the same time period from the RDS. We proposed to measure the LAN availability as the number of scans generated by the DRP that were missing from the RDS.

The two locations we proposed to use for this demonstration and the corresponding wireless network connections were: NASWI, which has Internet access through both a cellular network air-card and a Wireless Fidelity (WiFi) IEEE 802.11b access point with a directional antenna; and SEA, which has a point-to-point WiFi link to an internal network.

Users of avian radar systems expect the availability of a wireless network to be reasonably high, as they require real-time access to the radar data from remote locations, especially those on the airfield. We therefore established the metric for the successful demonstration of Performance Criterion SC4.1 that the calculated availability of each of the wireless LAN connections must be at least 50%.

Methods

We selected two radars to demonstrate SC4.1: The midfield radar at SEA, SEAAR1m, because it is the only wirelessly connected radar installation at that location; and the eBirdRad at NASWI, because of its long period of continuous operation. We chose 12 May 2009 and 26 November 2009 as the 24-hour continuous datasets for the SEAAR1 and eBirdRad radars, respectively.

During the periods of continuous operation, the DRPs of each radar archived plots and tracks data locally. They also streamed those same data continuously to a remote RDS at ARTI. We assumed the locally archived plots and tracks datasets to be lossless (containing every scan of

data that was generated by the radar), while the RDS records would contain only the scans of data that were successfully transmitted from the radar, over the wireless LAN connection, and over the Internet to ARTI.

We transferred the locally recorded plots and tracks data files from the remote locations to ARTI. We also extracted the corresponding data records for each radar from the RDS and converted the records into the plots and tracks format to facilitate comparison with the locally recorded files.

Finally, we wrote a script to extract the scan times from each of the four plots and tracks datasets and to output each set into a text format that we then imported to a Microsoft Excel® worksheet. We used the Excel® worksheet to compare the number of scans present in the locally archived and RDS datasets.

Results

Table 6-30 summarizes the comparison of the scan times from the locally archived plots and tracks data of two radars with the corresponding scan times from the same data records that had been transmitted over a wireless network to, and stored in, a remote RDS.

Table 6-30. Calculated uptimes for two radars, based on a comparison of the scan times in the plots and tracks records archived locally with the scan times for the same data records that were transmitted over a wireless LAN to a remote RDS.

Radar	Date Data Were Recorded	Number of Scans			Uptime (%)
		Archived	From RDS	Dropped	
SEAAR1m	12 May 2009	34598	34153	445	98.7
eBirdRad	26 November 2009	29091	28870	221	99.2

Based on these comparisons, the wireless LAN at SEA was available 98.7% of the time (i.e., 1.3% of the scan times in the local SEAAR1m dataset were missing, or “dropped”, from the same data on the remote RDS), while the wireless LAN at NASWI had 99.2% uptime.

Conclusion

We successfully demonstrated Performance Criterion SC4.1, Wireless LAN Availability: The calculated wireless LAN uptimes at SEA and NASWI were found to be 98.7% and 99.2%, respectively, compared to the performance metric of 50% uptime set for this criterion. This criterion demonstrates, along with other connectivity criteria (see Sections 6.3.1.1, 6.3.1.2, and 6.3.1.6), that the ability of the avian radar systems evaluated by the IVAR project to stream data, both locally and remotely, across both wired and wireless networks, is highly reliable under typical operational conditions.

6.4 DATA INTEGRATION

6.4.1 Quantitative Performance Criteria

6.4.1.1 Near Real-Time Integration For Expanded Local Coverage [SD1.1]

Objective

We designed Performance Criterion SD1.1, Near-Real-Time Integration for Expanded Local Coverage, to assess the capacity for streaming bird track data from two or more radars separated by at least 9 km (5 nmi) in near-real time to side-by-side TVW displays. The difference in the time (i.e., the latency) the track data from the two radars reaches the side-by-side displays impacts the level of situational awareness that can be provided to system users. Ideally, we would expect this latency to be 10 seconds or less (i.e., the equivalent of approximately 4 scan periods).

We established as the performance metric for SD1.1 that screen captures would be taken of side-by-side TVW displays from two widely separated radars every five minutes for one hour (for a total of 12 screen captures), and that the latency in each of the TVW displays should not to exceed 10 seconds. The two radars to be used in this demonstration were to be selected from the following set of four locations: NASWI, SEA, Edisto, or ARTI (if needed).

Methods

We selected as the two radars for the demonstration of Performance Criterion SD1.1: One (SEAR2u) of the dual rooftop radars at SEA, and one (AR1 CEAT) of the mobile radars at NASWI. The SEA and NASWI radars are 104 km apart. The plots and tracks data from these two radars were streamed to an RDS at ARTI. The dual-monitor workstation we selected for this demonstration resided at ARTI on the same network as the RDS.

In order to measure the latency in each of the TVW displays simultaneously, we ran a separate instance of the TVW in full-screen mode on each monitor. We connected each TVW to the appropriate schema on the RDS in order to stream radar data in near-real time to the displays. We installed Meinberg NTP client software on each DRP and on the dual-monitor workstation to ensure that each machine was synchronized to the same time source (i.e., 0.us.pool.ntp.org).

We used software to capture images of the extended desktop at 5-minute intervals for one hour, while each TVW was streaming live radar data from the RDS. The timestamp of the most recent radar scan is visible at the bottom of the TVW screens in the screen captures. The filename of the images generated by this process included the timestamp of the local workstation. We highlighted and enlarged the timestamps in each screen capture to facilitate comparing the times of the two TVWs. (e.g., Figure 6-98)

The Accipiter® DRPs insert the current time (UTC) from their system clock into the plots and tracks records as they are generated. The DRP can, optionally, stream those records across a LAN and/or WAN (the Internet) to an RDS. For this demonstration, the RDS was at ARTI. There the records are streamed into a database schema for that DRP and redistributed to one of the two TVWs running on the dual-monitor workstation. Since the system clock on the dual-monitor workstation and the clocks on the DRPs were synchronized to the same NTP time source, we defined the latency of these systems as: For any given target track record, latency is the difference between the DRP-generated timestamp displayed by the TVW and the system time

of the dual-monitor workstation (i.e., the “reference time”). In this case, latency is a measure of how long it took a record to be processed by the DRP once it was time-stamped, streamed across the network(s), loaded into the RDS, and redistributed to the TVW.

We recorded timestamps from each of the screen captures in a Microsoft Excel® workbook and calculated the latencies as the difference between the local reference workstation time (as recorded in the screen capture filename) and the timestamp for each of the TVWs.

Results

Figure 6-98 through Figure 6-100 are representative screen captures taken during the SD1.1 demonstration. The time values for all 12 screen captures are presented at 5-minute intervals in **Table 6-31**

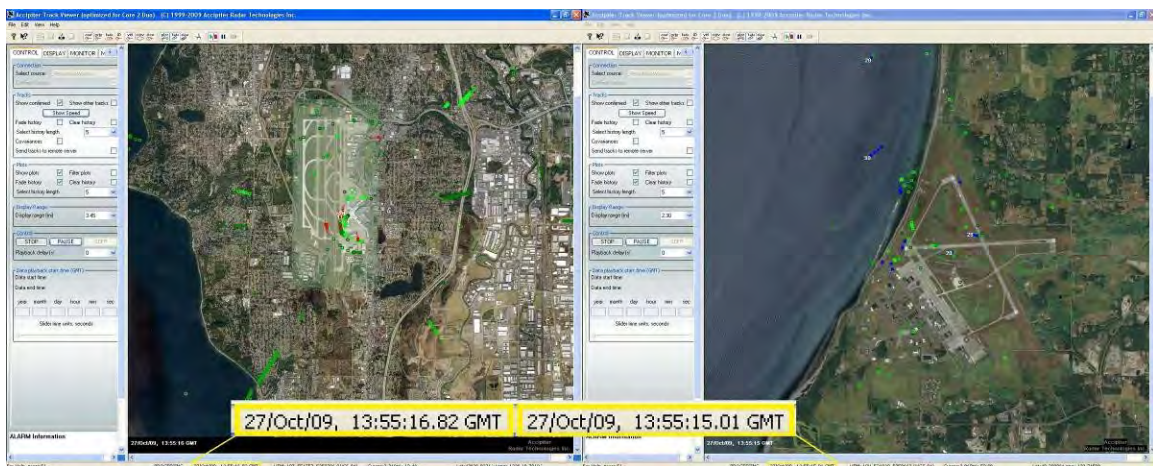

Figure 6-98. Screen captures for Sample #1 (+5 minutes) from the SEAR2u radar at SEA (left) and the AR1 CEAT radar as NASWI (right). Reference time is 13.55.20 UTC.

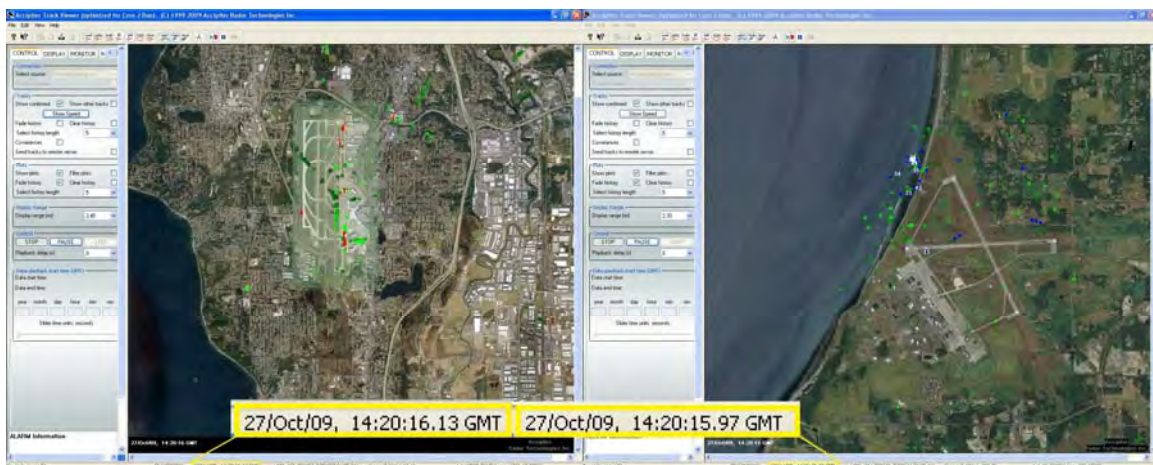

Figure 6-99. Screen captures for Sample #6 (+30 minutes) from the SEAR2u radar at SEA (left) and the AR1 CEAT radar as NASWI (right). Reference time is 14.20.20 UTC.

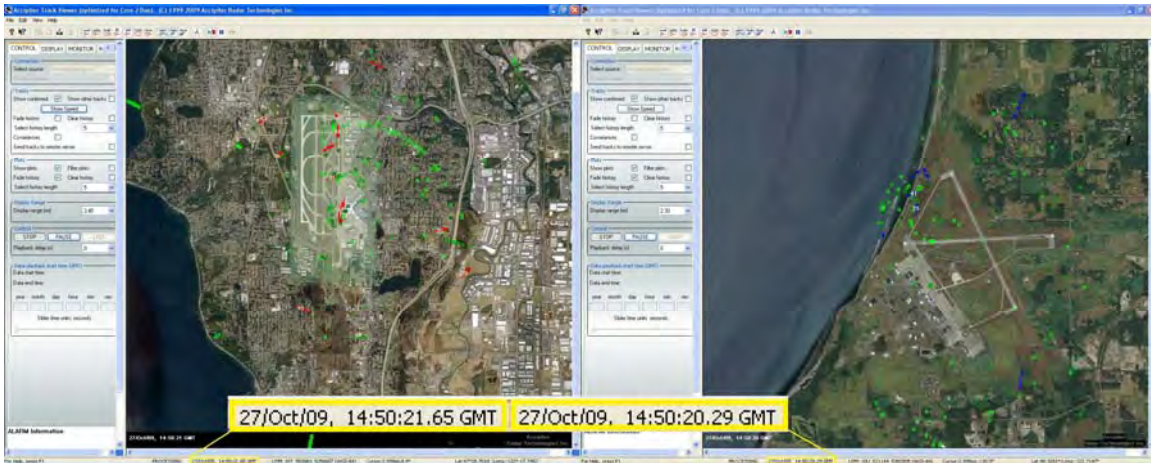

Figure 6-100. Screen captures for Sample #12 (+60 minutes) from the SEAAR2u radar at SEA (left) and the AR1 CEAT radar as NASWI (right). Reference time is 14.50.23 UTC.

Table 6-31. Calculated latencies from screen captures. All clock time values are reported in UTC.

Screen Capture (Sample #)	Reference Time (hh:mm:ss)	TVW Timestamp (hh:mm:ss.00)		Latency (s)	
		SEAAR2u	AR1 CEAT	SEAAR2u	AR1 CEAT
1	13:55:20	13:55:16.82	13:55:15.01	3	5
2	14:00:06	14:00:03.29	14:00:01.44	3	5
3	14:05:18	14:05:15.26	14:05:13.93	3	4
4	14:10:57	14:10:55.59	14:10:52.75	1	4
5	14:15:14	14:15:11.38	14:15:10.85	3	3
6	14:20:20	14:20:16.13	14:20:15.97	4	4
7	14:25:23	14:25:19.47	14:25:18.74	4	4
8	14:30:23	14:30:19.97	14:30:18.91	3	4
9	14:35:21	14:35:17.65	14:35:16.52	3	4
10	14:40:25	14:40:18.58	14:40:19.49	6	6
11	14:45:25	14:45:19.87	14:45:19.80	5	5
12	14:50:23	14:50:21.65	14:50:20.29	1	3

We calculated the mean latencies observed in the screen captures of the SEAAR2u radar at SEA and the CEAT AR-1 radar at NASWI to be 3 seconds and 4 seconds, respectively. Both of these average latencies represent less than 2 scans periods of ~2.5 seconds each. The overall range of latencies we observed was between 1 second and 6 seconds. Thus, the average and the range of latencies are both well less the performance target latency of 10 seconds.

Conclusion

We successfully demonstrated Performance Criterion SD1.1: The latencies we observed in side-by-side TVW displays of remote radar data streamed from the SEA SEAAR2u radar and the NASWI AR1 CEAT radar to an RDS at ARTI were less than the target threshold of 10 seconds

for all 12 screen captures taken over a one-hour period. Short latencies will afford system users a high level of situational awareness when viewing radar feeds in separate TVW displays.

6.4.1.2 Near Real-Time Integration for Common Operating Picture [SD2.1]

Objective

We designed Performance Criterion SD2.1, Near-Real-Time Integration for Common Operational Picture, to build on the results of Performance Criterion SD1.1 (Section 6.4.1.1) by assessing the further step of integrating in real time the tracks from two separate radars into a single common operational picture (COP). This capability will give end-users better situational awareness by making the target track information from multiple radars available in a single display.

We specified as the SD2.1 metric (see **Table 3-1**) that we would sample the time differences (i.e., latencies) of the integrated, real-time radar feeds at five-minute intervals over a period of one hour. We further specified that the latencies from these comparisons should be 10 seconds or less to ensure effective temporal integration of the target data.

Methods

We chose the two rooftop radars from SEA (SEAAR2u and SEAAR2l) as the sources for demonstrating near real-time integration of tracks into a COP. The plots and tracks data from these two sources were streamed in real time across the Internet from SEA to separate schemas on an RDS at ARTI, over 3300 km from SEA. From the RDS we streamed the two live radar feeds into separate instances of the TVW application running on a workstation that was on the same network as the RDS at ARTI. We also streamed these two radar feeds from the RDS into a single instance of Google Earth running on the same workstation as the TVWs. **Figure 6-101** illustrates the connectivity between these components. We also installed Meinberg NTP client software on each DRP at SEA and the workstation at ARTI to ensure that each machine was synchronized to the same time source (0.us.pool.ntp.org).

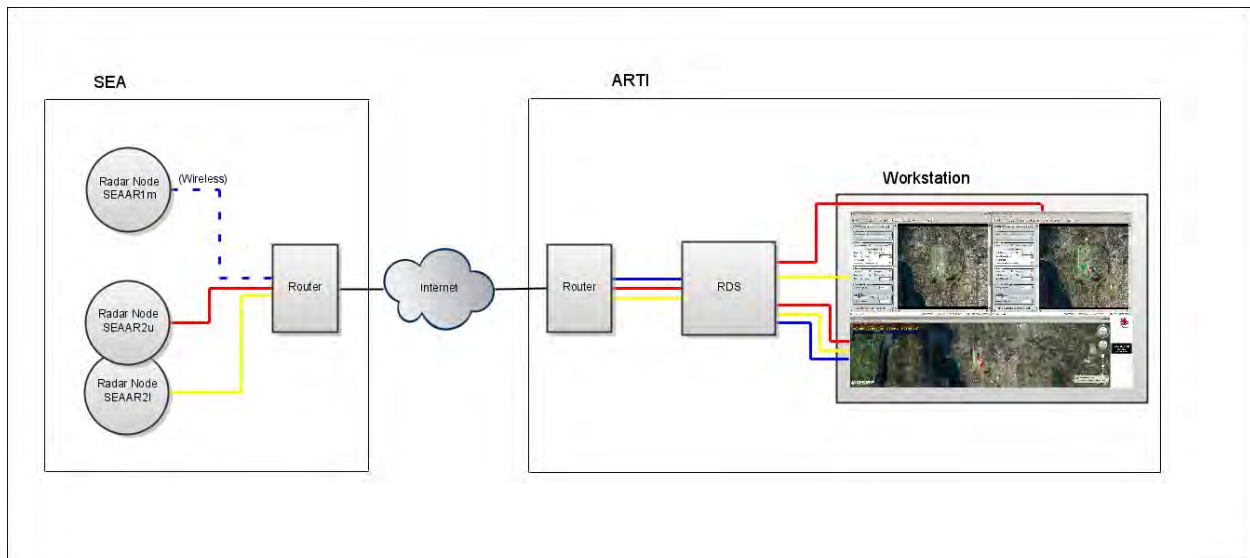

Figure 6-101. Simple connection diagram: SEA radars to workstation at ARTI

We used a screen-capture program at 5-minute intervals to take images of the three applications (two TVWs, one Google Earth) as the live radar data were streamed to them. The time stamp of the last radar scan is visible in the screen captures at the bottom of each TVW display and at the top of the Google Earth screen. The reference (workstation) time is also visible in the lower-right corner of each screen capture. This layout is shown in **Figure 6-102**.

We maintained consistency in the color-coding of the tracks from the two radars among the TVW displays and the Google Earth COP. Tracks from the SEAR2u radar at SEA were displayed in red, while tracks from the SEAR2l at SEA were displayed in yellow, as seen in Figure 6-101 and Figure 6-102.

We used a Microsoft Excel® workbook to record all four timestamps and the local (reference) time from each screen capture. We calculated the latencies as the difference between the local reference time and the corresponding TVW and Google Earth timestamps.

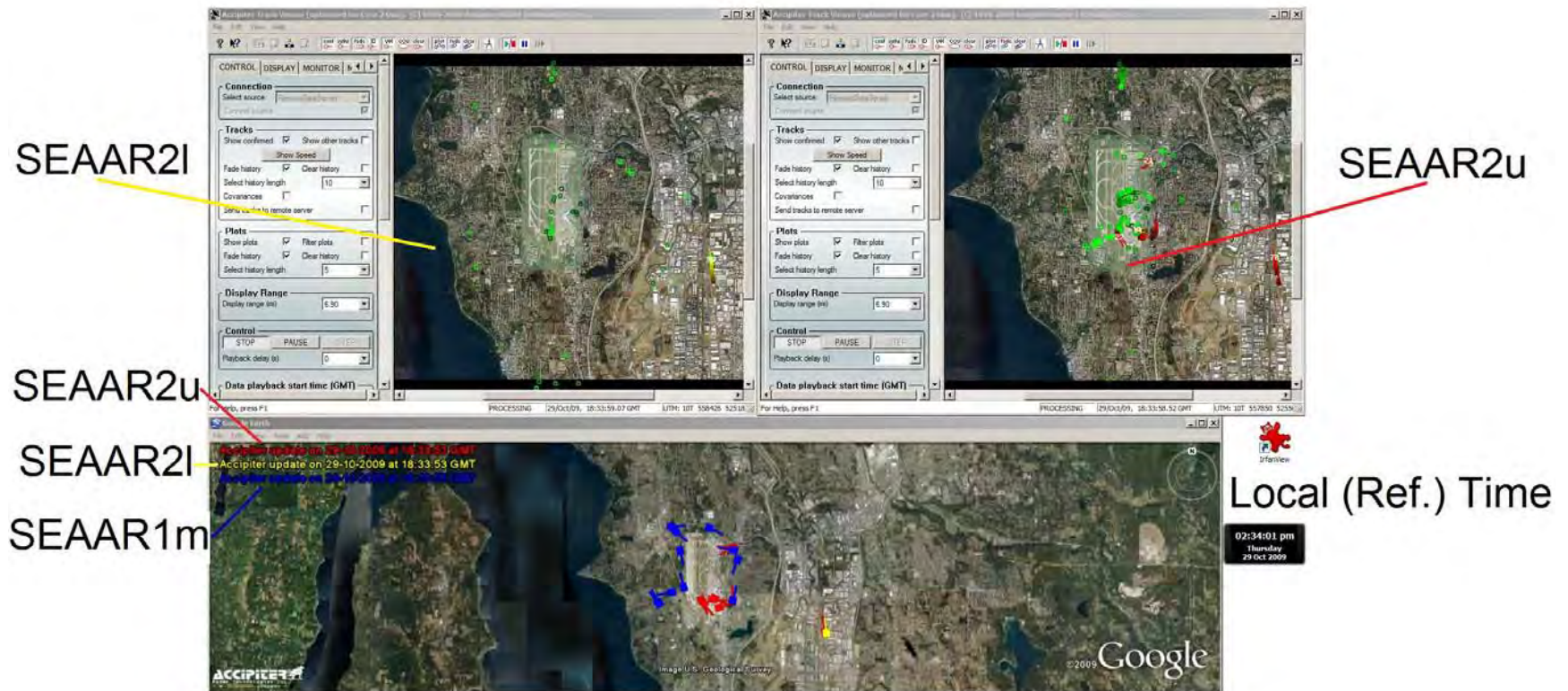

Figure 6-102. Workstation COP layout. Side-by-side TVW application windows above, with separate feeds from SEAAR2u and SEAAR2u radars at SEA in each window; Google Earth window below, with both live radar feeds presented in a single integrated display (i.e., COP). SEAAR1m is a mobile radar on the ground at SEA that was not used in this demonstration.

Results

Table 6-32 records the timestamps and calculated latencies from the twelve screen captures.

Table 6-32. Latency of live radar feeds from the SEAAR2u and SEAAR2l radars at SEA streamed to separate instances of the TVW application and to a single instance of the COP visualization tool, Google Earth (GE). All real-time clock values are expressed in UTC.

Screen Capture	Local (Reference) Time	Timestamp				Latency (ref time - timestamp, ss)			
		TVW (hh:mm:ss.00)		GE (hh:mm:ss)		TVW		GE	
(Sample #)	(hh:mm:ss)	SEAAR2u	SEAAR2l	SEAAR2u	SEAAR2l	SEAAR2u	SEAAR2l	SEAAR2u	SEAAR2l
1	18:34:01	18:33:58.52	18:33:59.07	18:33:53	18:33:53	02	02	08	08
2	18:39:00	18:38:57.37	18:38:59.12	18:38:52	18:38:54	03	01	08	06
3	18:43:53	18:43:51.31	18:43:51.99	18:43:46	18:43:46	02	01	07	07
4	18:49:16	18:49:13.17	18:49:15.55	18:49:10	18:49:10	03	00	06	06
5	18:54:12	18:54:09.48	18:54:10.90	18:54:06	18:54:05	03	01	06	07
6	18:59:06	18:59:03.45	18:59:02.78	18:58:58	18:59:00	03	03	08	06
7	19:04:10	19:04:07.37	19:04:08.88	19:04:02	19:04:03	03	01	08	07
8	19:09:11	19:09:08.84	19:09:10.59	19:09:03	19:09:05	02	00	08	06
9	19:14:03	19:14:00.06	19:14:02.30	19:13:54	19:13:57	03	01	09	06
10	19:19:05	19:19:01.43	19:19:04.56	19:18:58	19:18:59	04	00	07	06
11	19:24:01	19:24:00.05	19:23:59.17	19:23:54	19:23:56	01	02	07	05
12	19:31:15	19:31:12.24	19:31:13.87	19:31:09	19:31:08	03	01	06	07
Average						02	01	07	06
TVW Average						02	GE Average		07

The calculated latencies for the TVW timestamps ranged from 0-4 seconds, with an overall mean latency of 2 seconds. The latencies in the Google Earth (GE) timestamps ranged from 5-9 seconds, with an overall mean latency of 7 seconds. We attribute the higher latencies in the Google Earth timestamps to the (default) refresh rate of 2.5 seconds that was specified in the kml²⁴ file we used for retrieving target information from the RDS. This setting meant that if new target information was available, it would not be retrieved for at least 2.5 seconds.

Conclusion

We successfully demonstrated Performance Criterion SD2.1 by establishing that the latencies of target track data streamed across the internet in real time from two radars and integrated into a common operational picture 3300 km away were 10 seconds or less. The ability to integrate track data from multiple radars into a single display (i.e., a COP) will provide air operations and natural resources management personnel better situational awareness of bird activity at their facilities. The COP display will provide increased coverage of the facility and beyond and the overlapping coverage by the radars will result in potentially fewer “blind spots”.

²⁴ KML is the file format developed by Google for displaying geographic data in an Earth browser such as Google Earth™.

6.5 DATA FUSION

6.5.1 Quantitative Performance Criteria

6.5.1.1 Spatial Alignment for Fusion between Two Radars [SD3.1]

Objective

Fusion is the process of combining tracks generated by independent radars with overlapping coverage into common tracks. We designed Performance Criterion SD3.1, Spatial Alignment for Fusion Between Two Radars, to demonstrate that two asynchronous radars can be spatially aligned within acceptable error to provide meaningful target data for fusion.

The association process of data fusion looks at how well a pair of tracks, suspected to be from the same target, match. Fusing target tracks from two independent radars with overlapping coverage requires alignment in two spatial dimensions (range and azimuth), and one temporal dimension. The combined misalignment in these three dimensions for a pair of tracks must be relatively small in order to successfully associate the separate tracks with the same target.

Several IVAR study locations have two operating radars with overlapping coverage, including: SEA, NASWI, and MCASCP. We reviewed recorded tracks from these three pairs of radars in order to identify periods of time when they were tracking the same targets. Our goal was to identify commonly tracked targets (at least one for each radar pair) in order to compute the spatial misalignment errors for each.

In order to successfully demonstrate Performance Criterion SD3.1, the misalignment error for each pair of radar tracks must be less than three times the a priori spatial uncertainty (Appendix B defines how the a priori spatial uncertainty is computed).

Methods

We selected SEA, NASWI, and MCASCP as the IVAR locations to be used in this demonstration. From this set of three we chose the following radar pairs with overlapping coverage:

- The SEAAR1m and SEAAR2u at SEA.
- The eBirdRad (or WIEBirdRad) and WIAR1 at NASWI.
- The MCASCP eBirdRad and a second eBirdRad unit that were both used in an exercise north of MCASCP.

We reviewed the target data from each site and selected three datasets. The location and time period of each dataset are summarized in Table 6-33.

Table 6-33. Tracking events selected for demonstration of spatial alignment.

Location	Time Period
NASWI	Nov 13 2009, 01:54 – 02:10 GMT
SEA	Oct 6 2009, 21:15 – 21:37 GMT
MCASP	Feb 14 2006, 20:03 – 20:15 GMT

We acquired the appropriate plots and tracks files from the pairs of radars for the specified time periods. We then used the TVW application to view datasets and identify commonly-tracked targets. Finally, we recorded the corresponding track IDs for each target (i.e., both radars had associated separate, unique track IDs with the targets that were common to both).

Next we loaded the plots and tracks files into the TDV application to identify appropriate tracks export them to both kml and text formats for comparison. The target tracks were plotted in Google Earth, which facilitated visual comparison of the spatial alignment of the pair of targets.

Figure 6-103 is a screen capture of the selected target from SEA, displayed in Google Earth. The tracks are color-coded according to their respective radar, the locations of which are also shown in the figure.

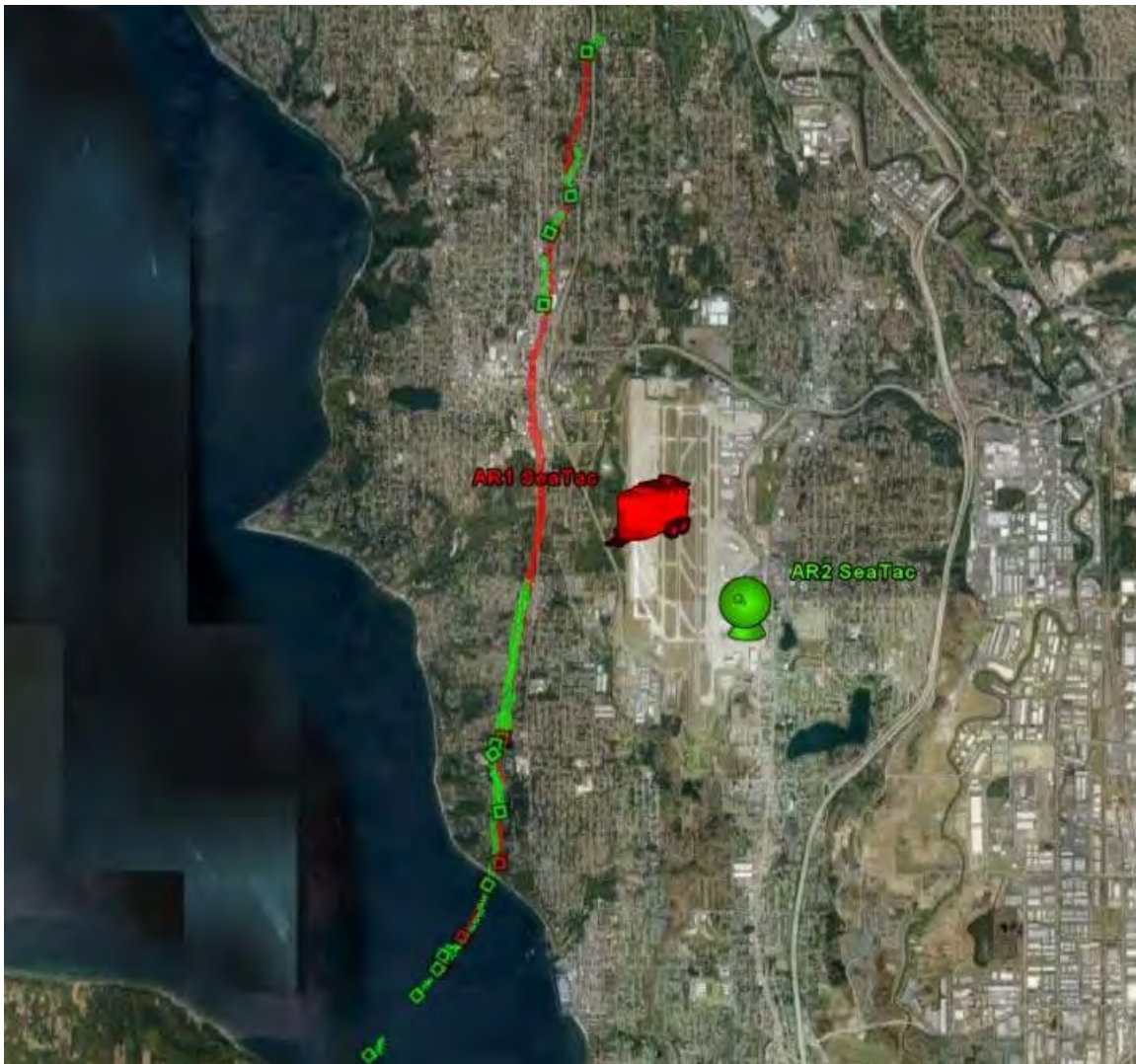

Figure 6-103. Track histories of target selected from SEAAR1l and SEAAR1u radars at SEA dataset for spatial alignment analysis. The green symbols represent the targets from SEAAR2u and the red represent SEARR1m.

Figure 6-104 is a similar screen capture for the selected target from the test exercise that was conducted north of MCASCP. The tracks are again color-coded according to their respective radar.



Figure 6-104. Track histories of target selected from the datasets for two eBirdRad radars at a site north of MCASCP for spatial alignment analysis. The green symbols represent the western eBirdRad unit the the red symbols the western unit.

We chose three common targets from the NASWI dataset: Figure 6-105 displays the associated tracks from of the radars.



Figure 6-105. Track histories of targets selected from WIAR1 and WeBirdRad radars at WASNI dataset for spatial alignment analysis. The green symbols represent the WeBirdRad unit and the red the WIAR1.

In order to demonstrate spatial alignment, we compared candidate track pairs from the respective datasets. Table 6-34 shows the first three rows from one of the track comparisons performed for the NASWI dataset; refer to Table 6-35 for the total number of track comparisons performed for the datasets from the three test locations.

Table 6-34. Comparison of corresponding track updates from two radars at NASWI on 13 November 2009.

Date	Track ID 408, WIAR1					Track ID: 607, eBirdRad					Distance (m)	Uncertainty (m)
	Time (h:mm:ss)	Head (deg)	Speed (m/s)	Latitude	Longitude	Time (h:mm:ss)	Head (deg)	Speed (m/s)	Latitude	Longitude		
11/13/2009	2:02:02	207	16.6	48.3593	-122.6912	2:02:02	203	17.7	48.3589	-122.6914	45.0	276.2
11/13/2009	2:02:05	207	16.6	48.3589	-122.6915	2:02:04	206	17.8	48.3586	-122.6917	34.1	276.2
11/13/2009	2:02:08	216	16	48.3588	-122.692	2:02:07	209	18.2	48.3582	-122.6921	66.8	273.2

Each row in Table 6-34 corresponds to track updates from the pair of radars. Because the radars are asynchronous, their times can differ by up to 1.2 seconds (see Section 6.5.1.2). We computed the spatial misalignment error (Distance) by taking the difference between the track positions for each update. The a priori spatial uncertainty (Uncertainty) was computed as per the

formula in part 6 of Method 6. The Distance and Uncertainty calculations were performed for every matching track update of each track pair.

Results

Table 6-35 summarizes the findings from the three datasets.

Table 6-35. Summary of computation of spatial misalignment errors (Distance) and a priori spatial uncertainty (Uncertainty) from pairs of radars at three IVAR study locations.

Site	Number of Comparisons	Average Distance (m)	Average Uncertainty (m)	Average Uncertainty x 3
SEA	176	69.6	302.2	906.6
MCASCP	51	79.0	600.2	1800.6
NASWI	54	62.8	257.2	771.6

The Number of Comparisons column refers to the number of track updates in which the common target was seen by both radars. For the NASWI dataset, 54 is the total number of comparisons we made for all 3 common targets.

In calculating the spatial misalignment error (Distance) and a priori uncertainty (Uncertainty) for each of the paired track updates, we observed that the spatial misalignment error was always significantly less than the a priori uncertainty. We have included in Table 6-35 the calculated average for both the Distance and Uncertainty values.

The data in Table 6-35 demonstrate the spatial misalignment error (Distance) was always significantly less than three times the a priori Uncertainty.

The Uncertainty values were calculated using a formula that was easy to calculate because it did not take into account target aspect angle, which is constantly varying, and that represents an upper bound on the location uncertainty of a track because it adds “in phase” all vector components of range, cross-range (azimuth), and motion uncertainties. This allowed us to set a worst case uncertainty as the basis for the spatial alignment test. Our conservative approach was necessitated because fusion with bird tracks had never before been attempted. The results obtained here are encouraging as they indicate that spatial misalignment errors can be managed to acceptable levels.

Conclusion

Performance Criterion SD3.1, Spatial Alignment for Fusion Between Two Radars, has been successfully demonstrated, showing that two asynchronous radars can be spatially aligned within acceptable error to provide meaningful target data for fusion. In this demonstration, the spatial misalignment error was well less than the a priori spatial uncertainty for each track pair.

6.5.1.2 Temporal Alignment for Integration between Two Radars [SD4.1]

Objective

As noted above, fusion is the process of combining tracks generated by independent radars with overlapping coverage into common tracks. Fusion requires that the radars be sufficiently

synchronized, both spatially and temporally for there to be meaningful, track-level data fusion. We designed Performance Criterion SD4.1 to demonstrate the latter of these two requirements for avian radars: That the time reference for two independent radars can be kept sufficiently in synchronization to support fusion.

We established as our metric for this demonstration of SD4.1 that the temporal misalignment between the time sources of the two radar processors must remain under 5 seconds over the course of one week to successfully demonstrate temporal alignment.

Methods

We selected the SEAAR2l and SEAAR2u rooftop radars at SEA for the demonstration of SD4.1. These radars continuously processed target data for the duration of this demonstration.

We installed an NTP client on the DRPs of the SEAAR2l and SEAAR2u radars. The NTP clients were synchronized to the following four time servers in the United States NTP time pool:

- server 0.us.pool.ntp.org
- server 1.us.pool.ntp.org
- server 2.us.pool.ntp.org
- server 3.us.pool.ntp.org

We enabled the logging capability on each NTP client, which writes the following single-line entry for each update of the local clock to a log file:

- Current date and time.
- Time offset (from NTP pool) in seconds.
- Clock frequency in parts per million (ppm).

We made use of the visualization utility that is supplied with the NTP client to plot the time offset and frequency for each DRP over the week of continuous operation. This utility program also supplies the global maximum (lead) and global minimum (lag) time offsets with respect to the NTP time pool. These values indicate how far ahead or behind the NTP time pool each of the DRP clocks strayed over the full week.

Results

We defined the one-week demonstration period to be 28 November 2009 16:00:00 UTC (29 November 2009 00:00:00 PST) through 5 December 2009 15:59:59 UTC (23:59:59 PST). We plotted the full-week time offsets and frequencies, as read from the log files, with the NTP visualization utility. The maximum lead and lag time offsets were also indicated in these plots. The results for the SEAAR2u and SEAAR2l DRPs are shown in Figure 6-106 and Figure 6-107, respectively.

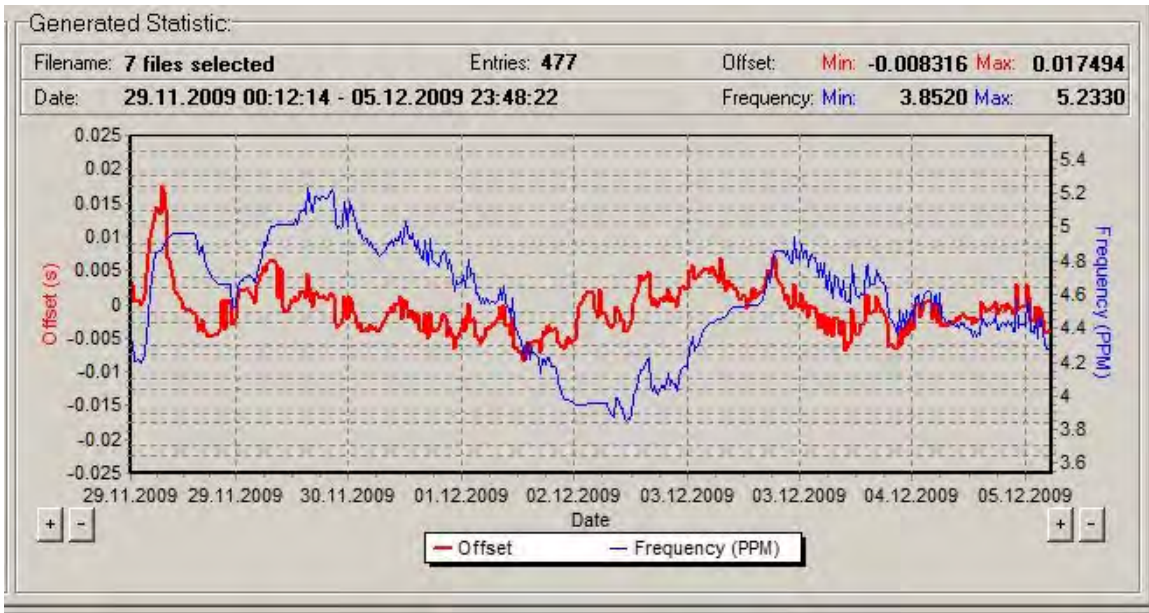

Figure 6-106. Plot of the time offset between the SEAAR2u radar DRP at SEA and the United States NTP time pool.

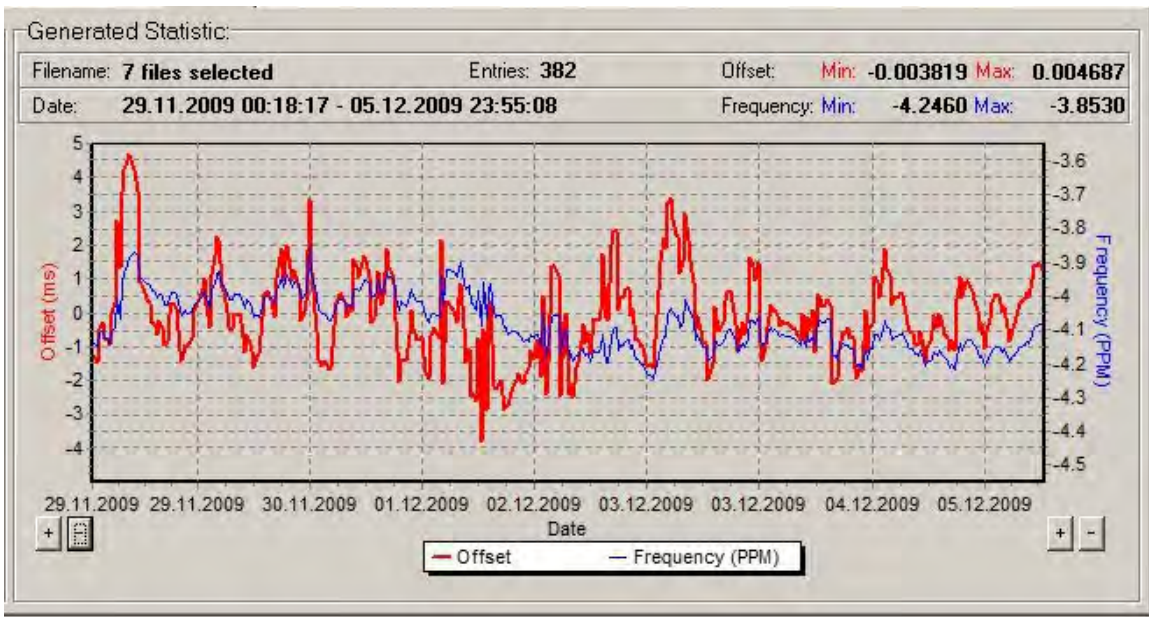

Figure 6-107. Plot of the time offset between the SEAAR2l radar DRP at SEA and the United States NTP time pool.

The global maximum (lead) time offset observed by the SEAAR2u DRP over the full week was 0.017494 seconds ahead of the NTP time pool. The global minimum (lag) time offset observed by the SEAAR2u DRP over the full week was 0.008316 seconds behind the NTP time pool. The global maximum (lead) time offset observed by the SEAAR2l DRP over the full week was

0.004687 seconds ahead of the NTP time pool. The global minimum (lag) time offset observed by the SEAAR2l DRP over the full week was 0.003819 seconds behind the NTP time pool.

We then calculated the worst-case maximum temporal misalignment between the SEAAR2u and SEAAR2l radars over the full week as the greatest spread between global maxima and minima timestamps over the entire week. This maximum temporal misalignment can be expressed as the greater of the following two differences:

- Expression 1: (SEAAR2u global maximum offset) – (SEAAR2l global minimum offset)
- Expression 2: (SEAAR2l global maximum offset) – (SEAAR2u global minimum offset)

Table 6-36 summarizes the result of each expression:

Table 6-36. Maximum temporal misalignment calculations.

Expression	Global Maximum (seconds)	Global Minimum (seconds)	Difference (seconds)
1	0.017494	-0.003819	0.021313
2	0.004687	-0.008316	0.013003

Table 6-36 shows that the maximum temporal misalignment over the full week was 0.021313 seconds, which is well below the target threshold of 5 seconds for Performance Criterion PD4.1.

Conclusion

Performance Criterion SD4.1 was successfully demonstrated: The temporal misalignment in the time references of two independent radars with overlapping coverage remained well within 5 seconds over a full week of continuous operation. The maximum misalignment was found to be 0.021313 seconds.

6.5.1.3 Data Fusion [SD5.1]

Objective

Our objective when designing Performance Criterion SD5.1, Near-Real-Time Fusion of Tracks from Two Radars with Overlapping Coverage, was to demonstrate that fusion algorithms used in the avian radars being evaluated by the IVAR project can be applied in near real time and presented in a single operator display (i.e., COP) that shows duplicate tracks consolidated, and in the process provides greater track continuity for targets moving from the coverage volume of one radar to the next.

This demonstration uses bird track data recorded at three demonstration locations: SEA, MCASCP, and NASWI. Two radars with overlapping coverage are operating at each of these locations. We selected a total of five paired datasets from these sites in the analysis and used the Accipiter® Radar Fusion Engine (RFE) to apply fusion processing on each paired dataset, as well as to display the resulting tracks using its built-in COP display.

We established as the success criterion for this demonstration that the RFE processing time for each paired dataset must be less than the respective actual time interval associated with that dataset.

Methods

We selected one paired dataset from MCASCP and SEA and three from NASWI for this demonstration. After measuring the amount of time it took the RFE to process a dataset with a 5-minutes or greater duration, we found that the fusion engine was running about 50 times faster than real time. To make the measurements we report more conservative and meaningful, we included in this section the fusion processing times from the more intensive computation intervals where fusion is actually taking place. The time intervals during which tracks from two radars are being fused varied in these studies from 1-13 minutes.

Following the procedures outlined in Method 6, we loaded each dataset from the RDS to the RFE for processing. The RFE also includes a COP for visualizing the fused tracks. We used a TVW to playback recorded datasets so that the tracks from the individual radars could be examined and compared with those from the COP. The graphical results we present below are screen captures taken from the COP or the TVW.

Results

Beginning with the data from NASWI, consider the fusion COP illustrated in Figure 6-108. This image was generated from our first paired dataset collected at NASWI on 13 November 2009.

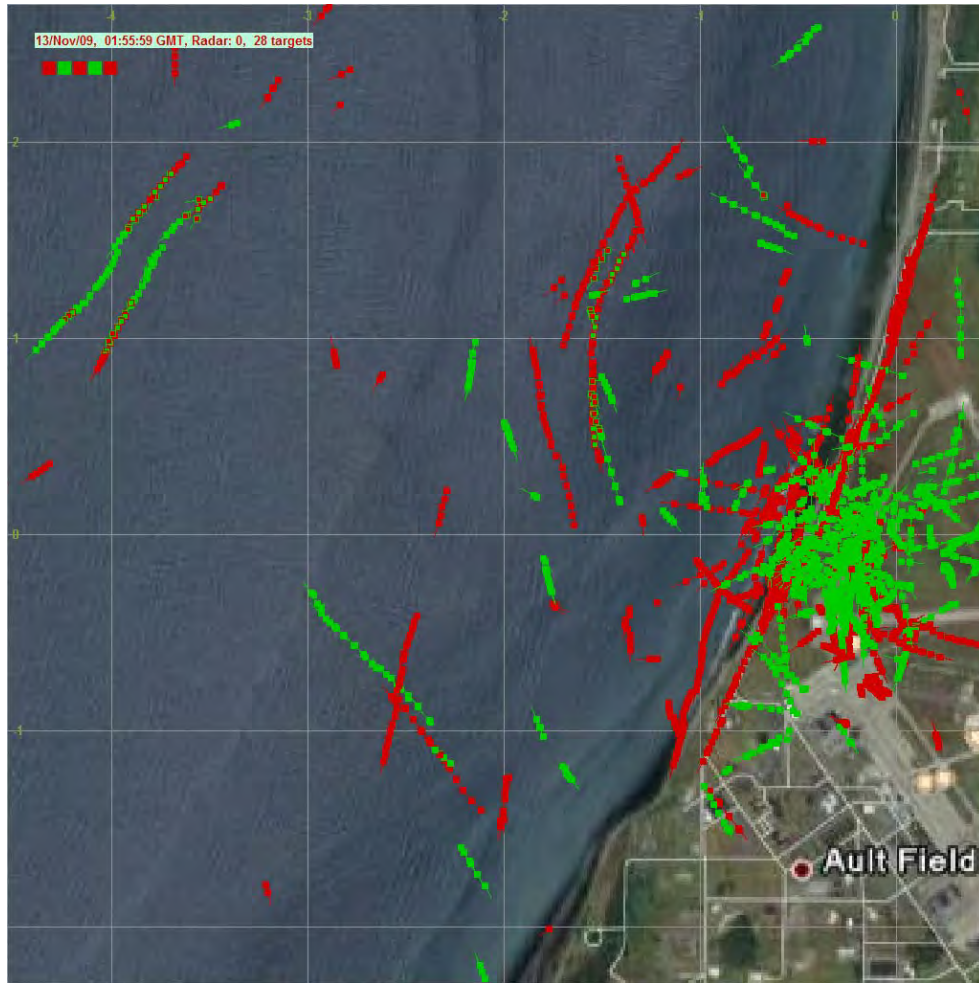

Figure 6-108: COP display showing fused tracks from the WIAR1 and eBirdRad radars at NAS Whidbey Island on 13 November 2009 at 01:55 UTC. Red tracks = WIAR1 radar; green tracks = WIEBirdRad radar.

In this example we have circled the two separate targets of interest, which are offshore to the northwest. These fused tracks are characteristic of two distinct flocks of birds traveling in the same direction (approximately southwest), a small distance from each other.

The fused tracks shown in Figure 6-108 were formed from track information from the two contributing radars: the WIAR1 tracks are displayed in red and the WeBirdRad tracks are displayed in green. The WIAR1 is a 25 kW, X-band radar with a 6-foot array antenna (short pulse); the WeBirdRad is a 50 kW X-band radar with a 4° dish antenna (short pulse). For the purposes of this demonstration, the antenna angle of the WeBirdRad radar was pointed to 5° above the horizontal so its beam would overlap with the beam from the array antenna of the WIAR1 radar. The array antenna covers elevation angles from 0°-10°, while the dish covers 3°-7°. The radars are located within 100 m of one other.

The targets shown in Figure 6-108 first appeared on the radars at 01:54:33 UTC, and had ended by 01:56:31 UTC – an interval of 118 seconds. The RFE took only 2 seconds to process this

sequence of data – a computation rate of more than 50 times real time. The flocks were travelling at a speed of ~15 m/s.

In the discussions that follow, two aspects of the displayed Track IDs are important to note. First, Track IDs generated by the DRP are large unique numbers. To reduce clutter from overlapping track labels on the TVW and COP displays, we display only the three least significant digits of the Track ID. Second, the RFE sets the Track ID of a fused track to the Track ID of the first (oldest) radar track that started the fused track. In this way, we maintain traceability back to the original radar

Figure 6-109 through Figure 6-111 provide a closer look at the tracks of interest, which will help to better understand the benefits of fusion in this case. These figures are not on the same spatial scale; they have been zoomed into the region where the tracks of interest are located, while still covering the time intervals in which these targets were tracked.

In Figure 6-109 we see that the WIAR1 radar generated four tracks: Track IDs 358, 185, 85 and 752. With no other information, one might conclude these represent four separate targets (i.e., flocks of birds). The WeBirdRad radar, on the other hand, generated two tracks (Track IDs 665 and 754) in the same area, indicating just two targets (Figure 6-110).



Figure 6-109: TVW display showing tracks from the WIAR1 radar at NASWI on 13 November 2009. The Track ID (only the three least significant digits) of each target is shown for each track update.



Figure 6-110: TVW display showing tracks from the eBirdRad radar at NASWI on 13 November 2009. The Track ID (only the three least significant digits) of each target is shown for each track update.

In Figure 6-111, we zoom into the region circled in Figure 6-108 to display the fused Track IDs.

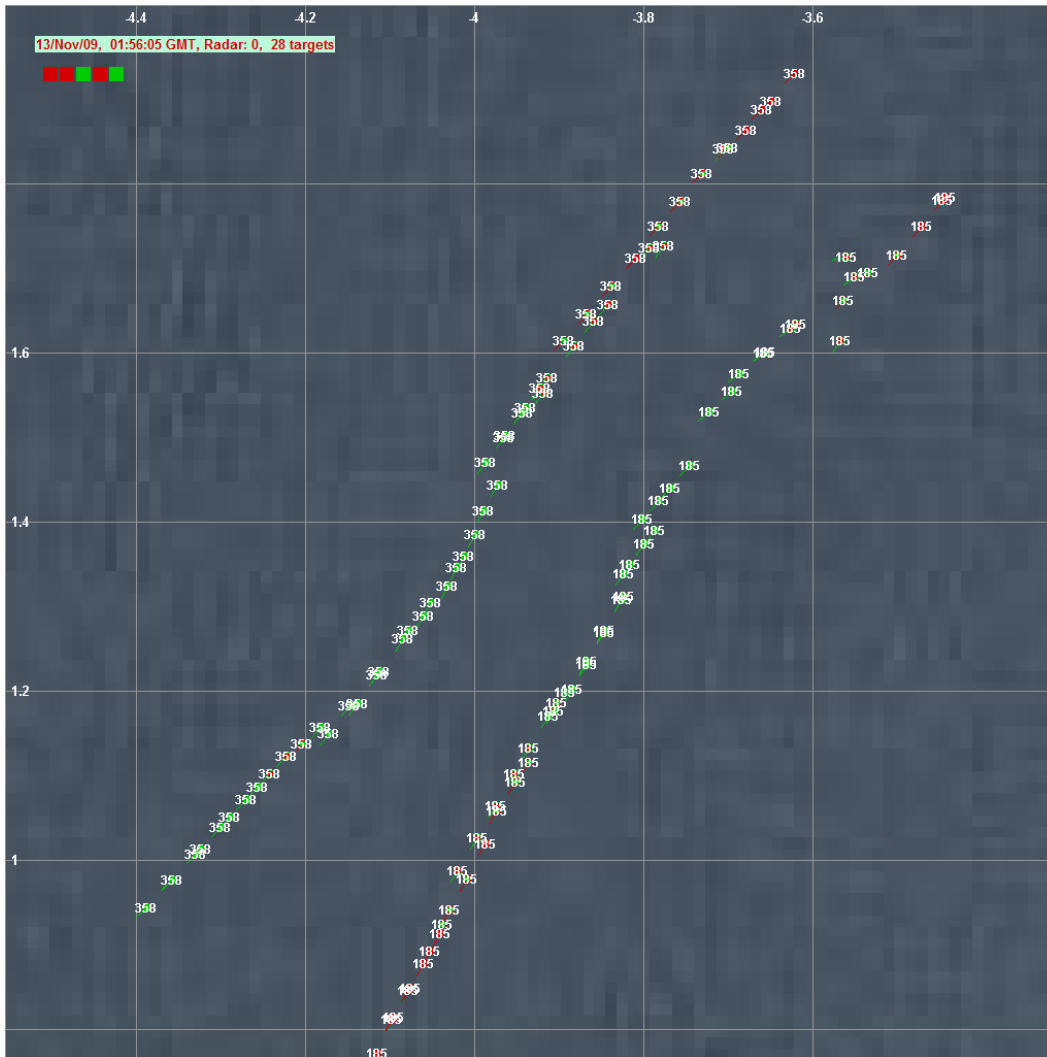

Figure 6-111: COP display showing fused tracks from the WIAR1 and eBirdRad radars for the two targets at NASWI on 13 November 2009. The display is zoomed into the region in question so that the *fused* Track IDs are readable. Note that the fused Track IDs maintained throughout the time interval in question are 358 and 185. East-West and North-South units are shown in kilometers.

Examining Figure 6-109 through Figure 6-111 more closely, it is easy to see the potential of fusion to improve track continuity and length and to provide better bird abundance information, thereby improving situational awareness. In particular:

- It is clear that there are only two targets, not four as might have been surmised from the WIAR1 alone.
- The broken WIAR1 tracks are continued, or filled in, using track information from the eBirdRad radar, thus improving track continuity.
- The fused tracks are longer than the tracks formed by either radar alone.

The next example from NASWI involved a single target that follows the same sequence of figures. The ends of the fused target track of interest are demarcated by the blue electronic bearing lines in Figure 6-112.

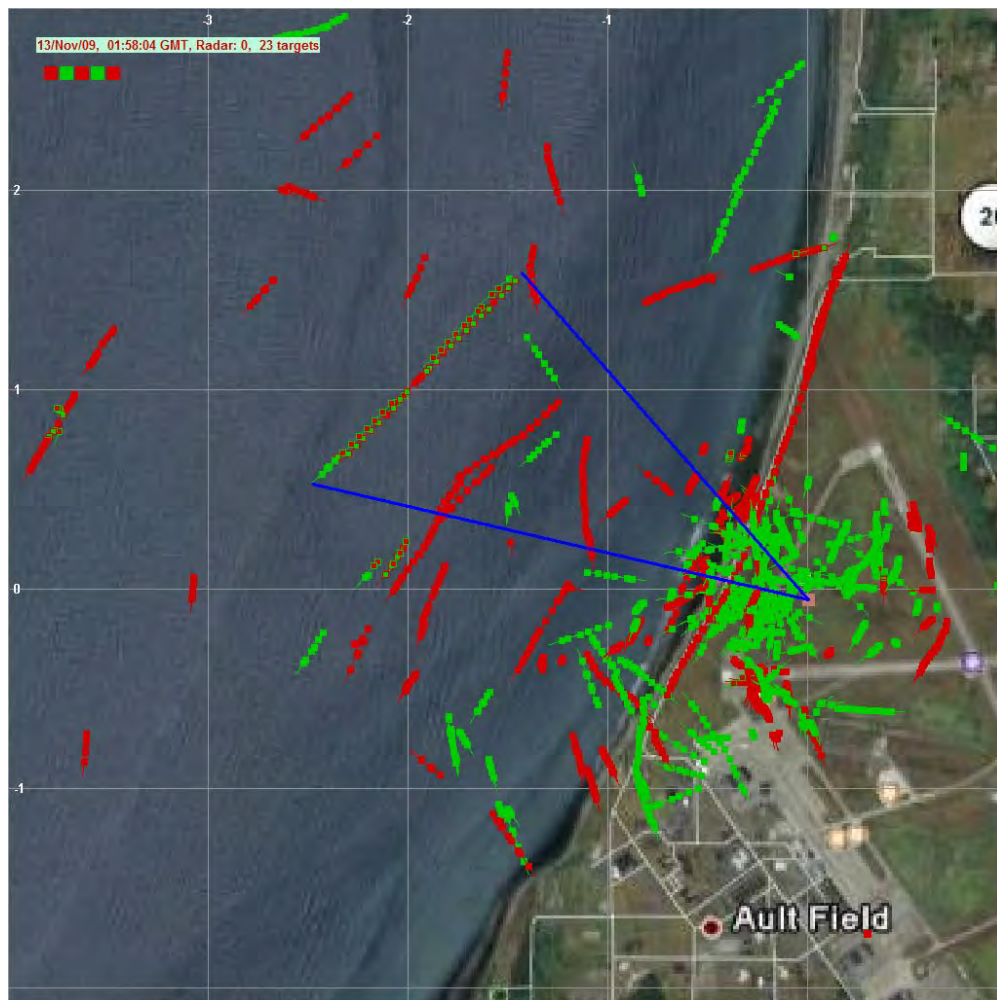

Figure 6-112: COP display of a highly fused track from the WIAR1 and WeBirdRad radars at NASWI on 13 November 2009. The single target is at the center of the display, moving in a southwesterly direction at a speed of ~19 m/s. Each gray grid cell is a 1 km by 1 km square.

The corresponding track contributed from the WIAR1 radar is Track ID 364 in Figure 6-113. The WeBirdRad radar contributed Track IDs 740 and 731, as illustrated in Figure 6-114.



Figure 6-113: TVW display showing tracks from the WIAR1 radar at NASWI on 13 November 2009. The Track ID (only the three least significant digits) is shown at each track update. The Track ID of interest is 364.

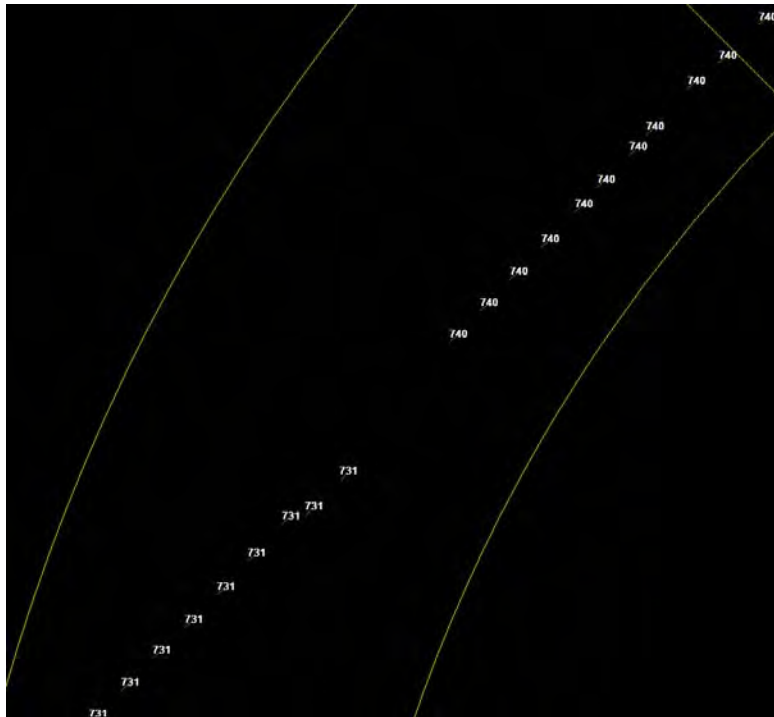

Figure 6-114: TVW display showing tracks from the WeBirdRad radar at NASWI on 13 November 2009. The Track ID (only the three least significant digits) is shown at each track update. The Track IDs of interest are 740, followed by 731.

The resultant fused track, Track ID 740 in Figure 6-115, maintains continuity across the combined time interval spanned by the two contributing radars. Here again we have demonstrated that fusion, by extending the duration of target tracks, not only improves track continuity, but also provides a better indication of the actual number of targets being tracked. The time segment for the track in this paired dataset encompassed the interval from 01:56:52 to 01:58:03 UTC – a period of 77 seconds. The RFE required approximately two seconds to process this dataset – a computation rate in excess of 30 times faster than real time.

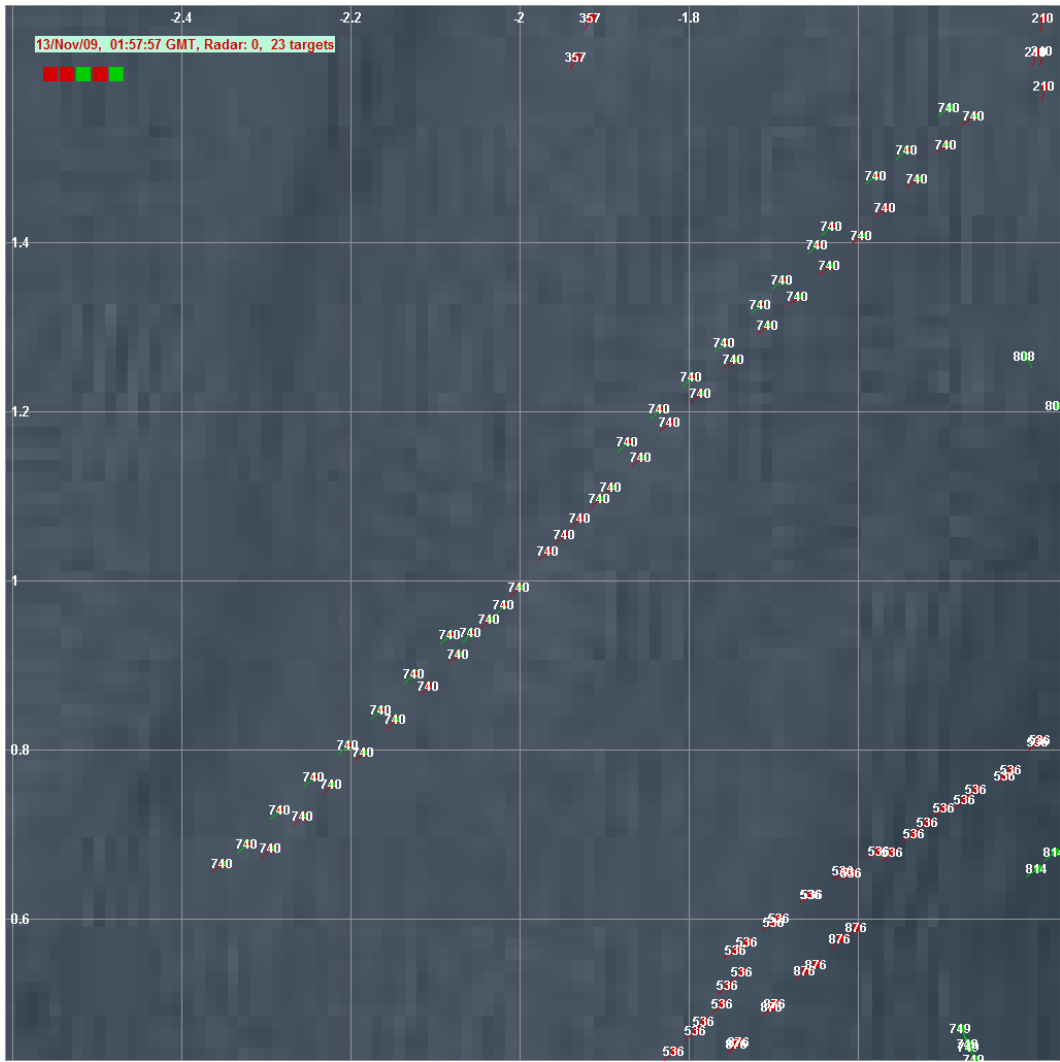

Figure 6-115: COP display showing fused track for the single target tracked by the WIAR1 and WeBirdRad radars at NASWI on 13 November 2009. Track ID 740 came from the WeBirdRad radar, which was the first to detect and track the target. The display is zoomed in to make the *fused* Track ID 740 readable: The grid units are shown in kilometers, and each grid cell is .2km by .2km.

Our third example from NASWI is a collection of tracks extending over approximately 2.5 minutes. This is a particularly challenging scenario because multiple tracks of mostly limited duration from each of the contributing radars are being acquired and deleted over the time-extent of the fused track. There was also a single long track that started a few scans after the first tracks in the collection and extended almost to the end of the fused track. Figure 6-116 is the COP display showing the fused tracks from this dataset. The 148-second time interval of the fused track, from 02:01:00 UTC to 02:03:28 UTC was processed in less than 4 seconds by the RFE – more than 30 times faster than real time.

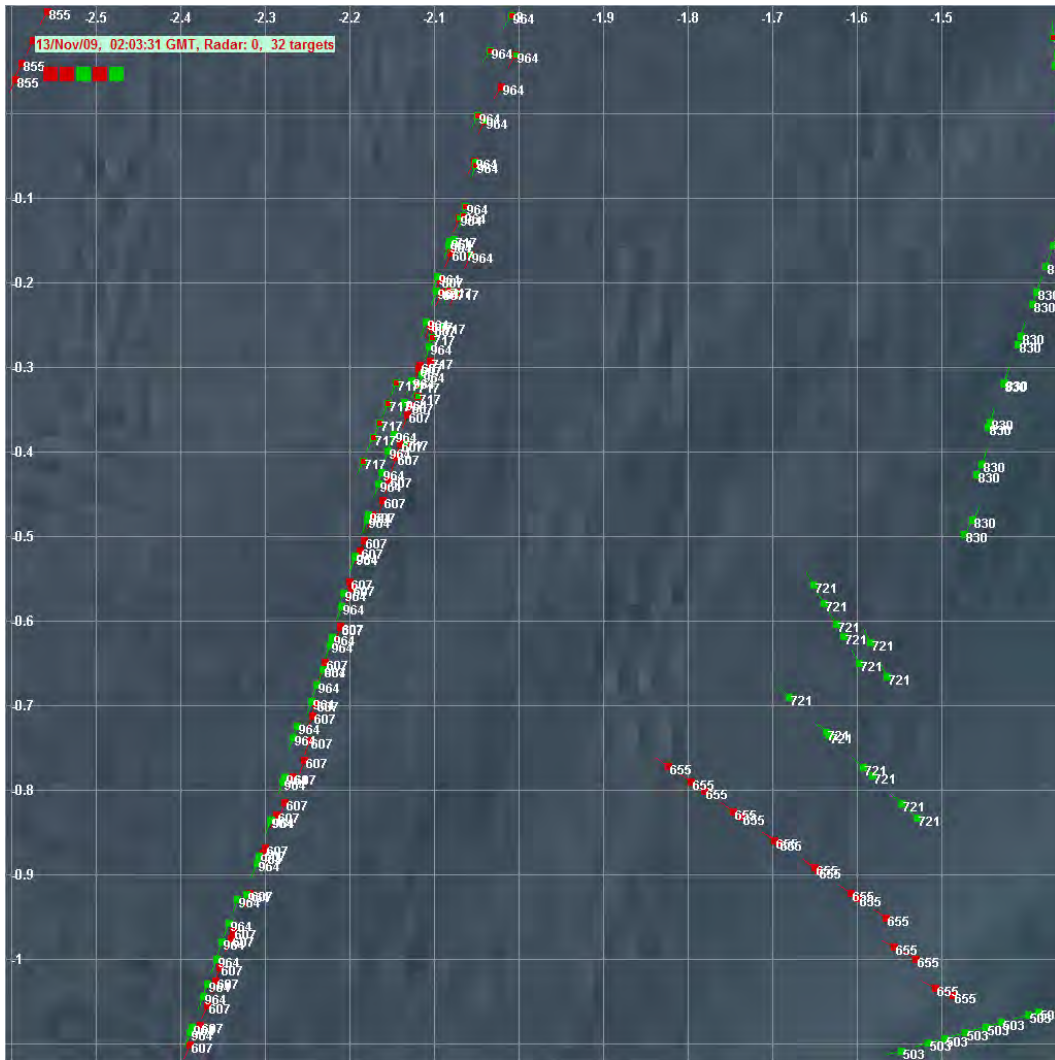

Figure 6-116: COP display showing a pair of fused tracks with Track IDs 964 and 607 that are maintained throughout most of the display.

We next turn our attention to an example from MCASCP, where two eBirdRad radars were deployed more than 10 km apart during a study in 2006 at a site in northeastern NC near the Pocosin Lakes National Wildlife Refuge. This example is particularly interesting because of the distance between the radars.

We used a paired dataset that was collected from the OLF on 14 February 2006. The area of interest includes a single long track, plus a number of shorter tracks. The tracks start at 20:11:00 UTC and end by 20:13:10 UTC – a period of 130 seconds. The RFE required just over two seconds to process these data – a computation rate of more than 60 times real time.

The COP display of the RFE can be used to simply integrate tracks from multiple radars without applying fusion processing. This is illustrated in Figure 6-117 showing the contributing tracks from both radars. The positions of the two eBirdRad radars during the study are indicated by the yellow pushpins in Figure 6-117. The tracks of interest are near the middle of the display, within the area bounded by the electronic bearing lines and the two purple range rings.



Figure 6-117: Integrated tracks (no fusion) from two MCASCP radars deployed to a site in Washington County, North Carolina, on 14 February 2006. The red tracks were generated by the western radar (yellow pushpin near the top-left of the display); the green tracks were generated by the eastern radar (pushpin at the extreme right, midway up the display). These two radars are over 10 km apart. The tracks of interest are those in the overlapped region shown near the middle of the display, contained within the range-azimuth region bounded by the circular range markers and the radial electronic bearing lines. Each gray grid cell in this figure represents a 1 km by 1 km square.

Figure 6-118 is a zoomed view of the area with the tracks of interest: Track ID 538 from the eastern eBirdRad radar is shown in red, while Track ID 184 from the western radar is shown in green. These two tracks are believed to represent the same target (flock or bird).

Fusion processing was enabled in the COP shown in Figure 6-119. Fused Track ID 538, which resulted from combining red Track ID 538 and green Track ID 184, covers a distance of approximately 2 km. This demonstrates the ability of the fusion process to reduce track duplicates in regions of overlap where the radars are widely spaced and providing wide-area surveillance.



Figure 6-118: Zoomed region of interest from two MCASCP radars deployed to a site in Washington County, North Carolina, on 14 February 2006, showing tracks from the respective radars with the Track IDs displayed. No fusion processing was applied. Green Track ID 184 (from eastern radar) and red Track ID 538 (from western radar) are long tracks.



Figure 6-119: Region of interest from two MCASCP radars deployed to a site in Washington County, North Carolina, on 14 February 2006, after fusion processing. Green Track ID 184 from the eastern radar and red Track ID 538 from the western radar have been combined into fused Track ID 538.

Our final example is selected from two radars at SEA: the SEAR1m radar (X-band, 25 kW, 1.8 m array antenna, short pulse), and the SEAR2l rooftop radar (X-band, 25 kW, 4° dish antenna, short pulse, pointed to 4° above horizontal).

The time segment for the tracks of interest within this paired dataset begins at 21:16:13 GMT and ends at 21:29:40 UTC on 06 October 2009 – a span of 13 minutes and 27 seconds (807 seconds). This example is of particular interest because the flock was tracked so long, travelling a distance of more than 11 km during this timeframe! The RFE processing time for this dataset was 26 seconds – approximately 30 times faster than real time. Given the duration of the fusion

processing associated with this dataset, we think the RFE processing rate derived from this example is realistic.

Figure 6-120 and Figure 6-121 display the tracks from the SEAAR1m (red) and SEAAR2I (green) radars, respectively. The collection of tracks for the flock of birds moving north to south is clearly evident in both figures. Individual tracks in the collection are moving at approximately 15 m/s, consistent with avian dynamics.



Figure 6-120: SEA SEAAR1m radar tracks over the 13 minute interval of interest on 06 October 2009. The long track extending from about 6 km north to about 5 km south is the flock of interest. The speed of individual tracks in this flock is about 15 m/s. The SEAAR1m radar has good coverage to the west of the airfield because the radar is in a bowl below runway grade, and hence has a natural clutter fence.

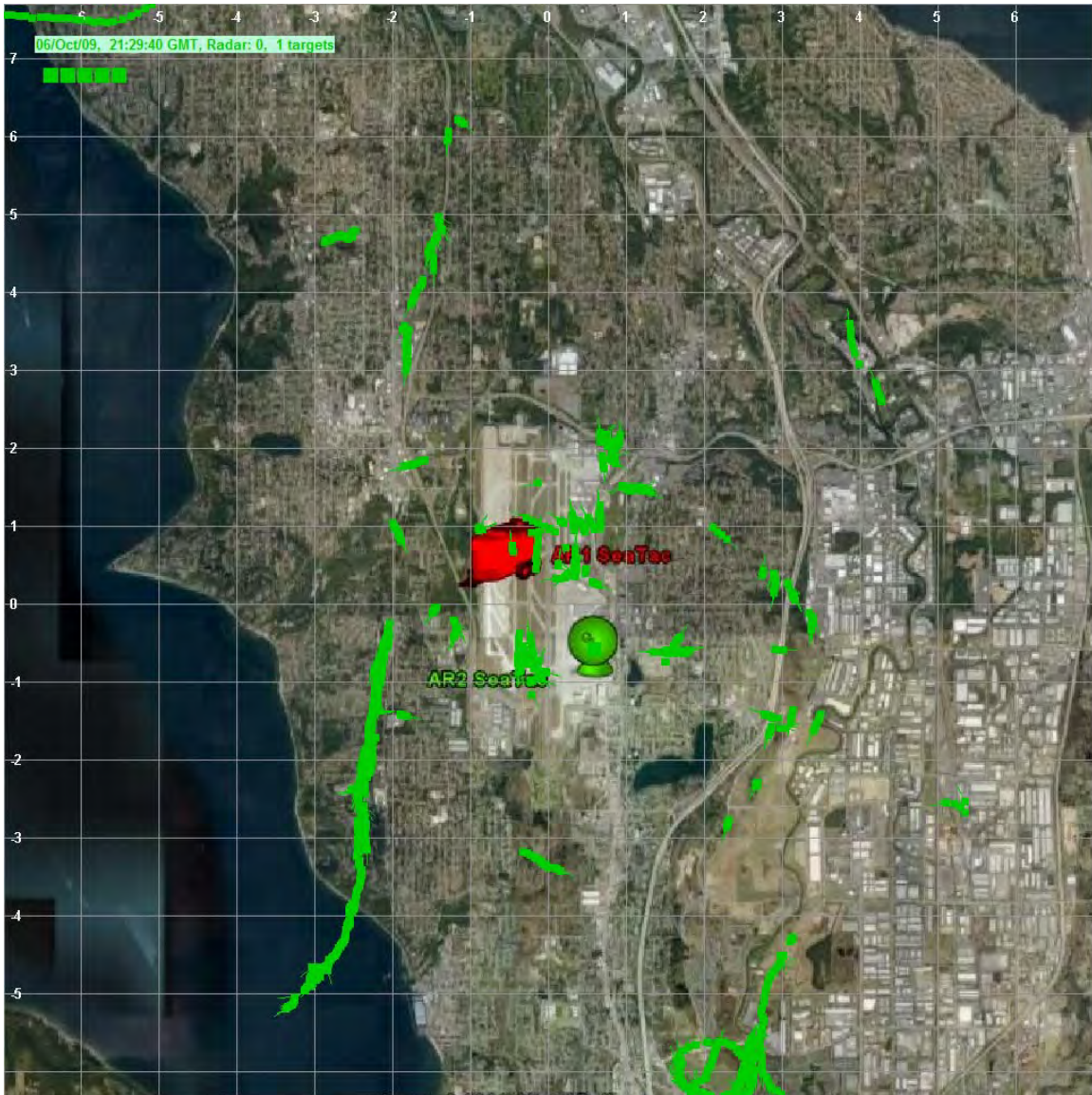

Figure 6-121: SEA SEAR2 radar tracks over the 13 minute interval of interest on 06 October 2009. The long track extending from about 6 km north to about 5 km south to the west of the airport represent the flocks interest. The speed of individual tracks in this flock is about 15 m/s.

The length of this dataset makes it impractical to display images for the entire duration of the tracks. Instead, we present only the results for the final segment of the tracks: Figure 6-122 shows the SEAR1m and SEAR2l Track IDs before fusion; Figure 6-123 shows the fused Track IDs for the same segment of time and space. Comparing these two figures reveals fusion in action: Track ID 126 and Track ID 7 have been joined to fused Track ID 169; Track ID 685 has been joined to fused Track ID 312; and Track ID 597 has been joined to fused Track ID 527. In other words, fusion joined four duplicated track fragments in this segment and increased track continuity in the process.

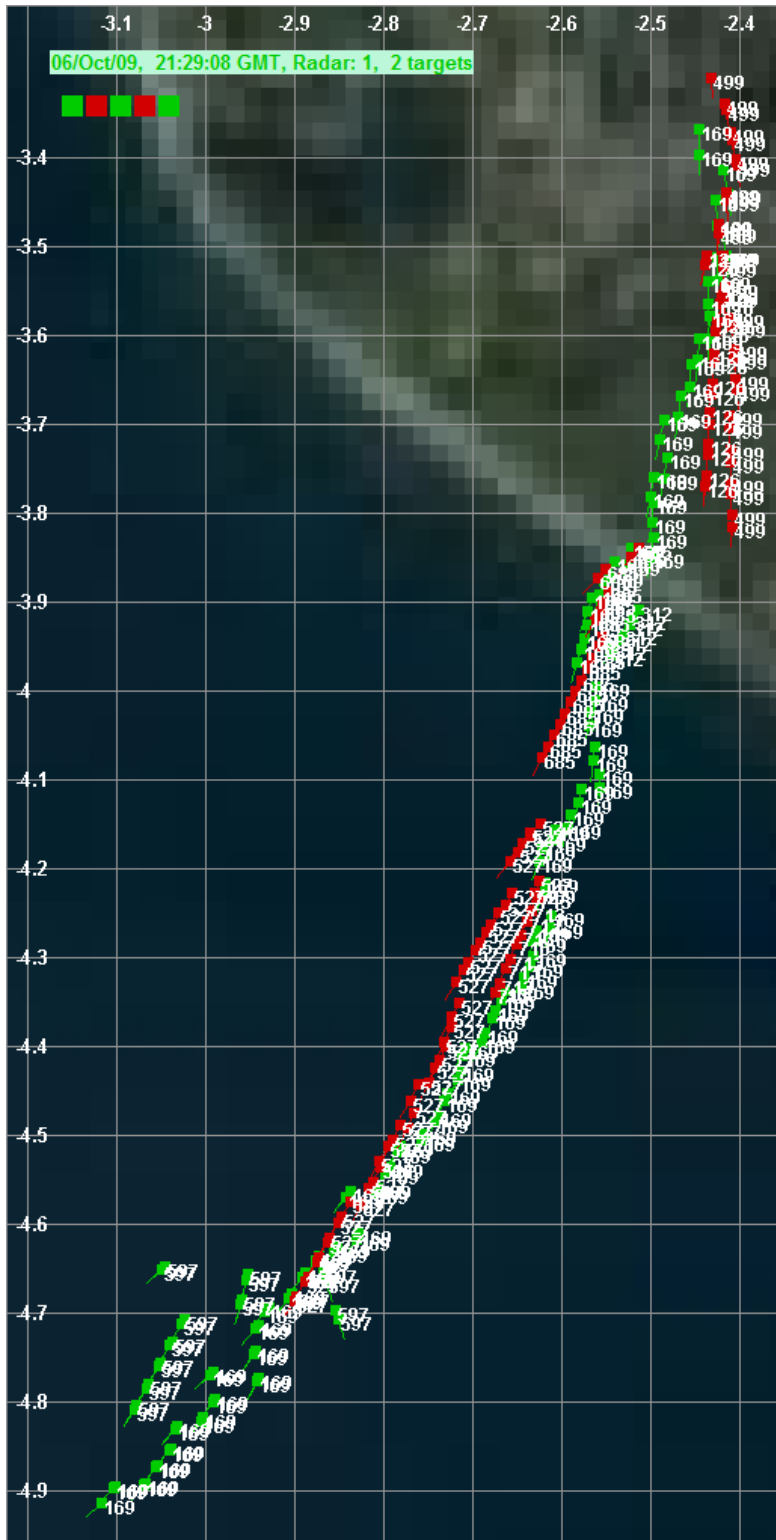

Figure 6-122: TrackIDs shown for both radars (i.e. fusion is not applied yet) at SEA on 06 October 2009.

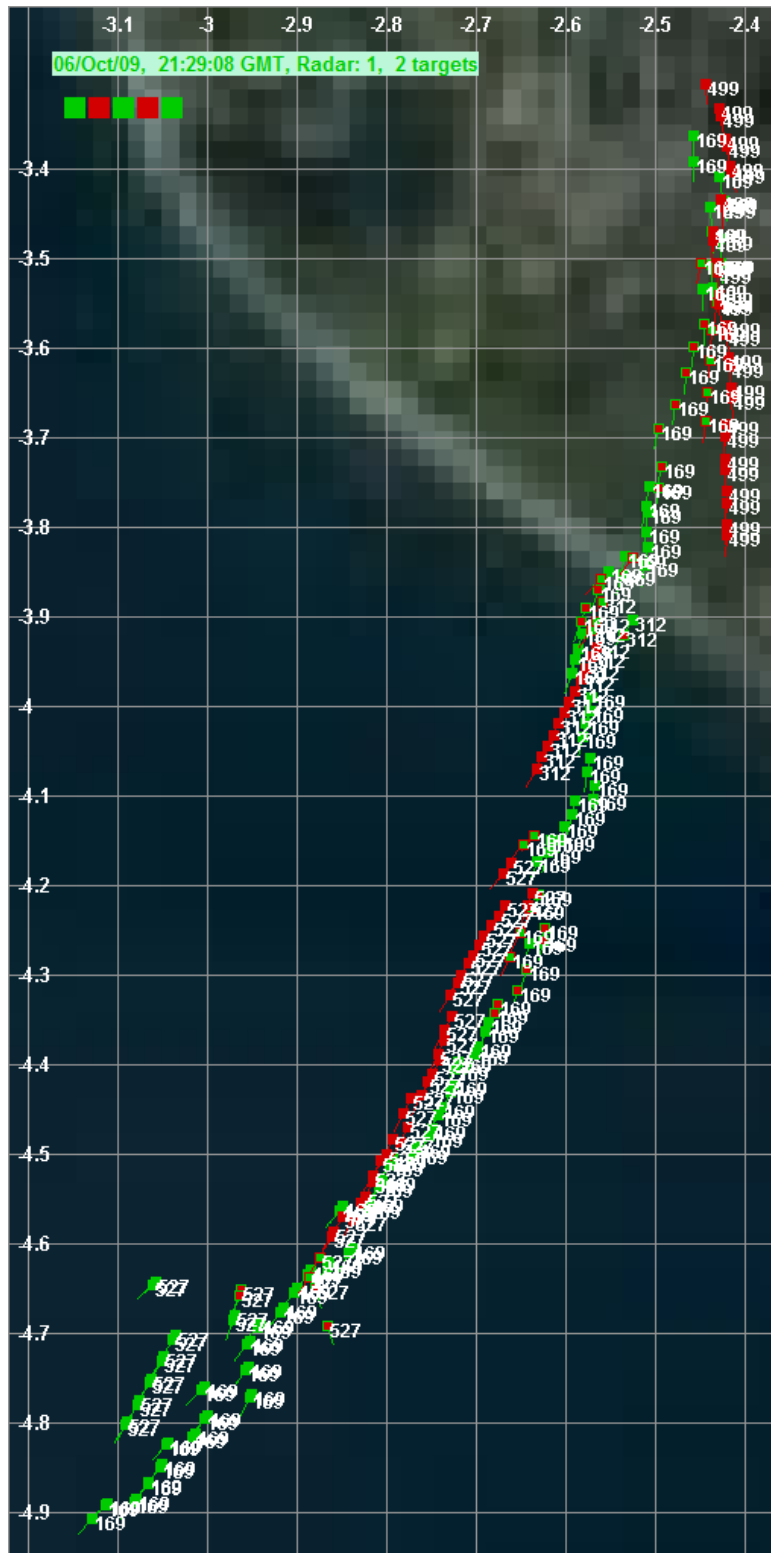

Figure 6-123: Fused Track IDs shown for tracks at SEA on 06 October 2009.

Conclusion

We successfully demonstrated Performance Criterion SD5.1 using diverse examples from three widely spaced locations, including a naval airfield and a commercial airport in the Pacific Northwest, and a site in an agricultural environment along the Atlantic coastal plain. Our examples included similar and dissimilar radars, as well as radars separated by small, medium, and long distances. Similarly, we demonstrated fusion processing over short, medium, and long observation times. The RFE processing time for each of the five paired datasets we analyzed was a small fraction of the actual time interval represented by each dataset, specifically, the computation rate of the RFE was approximately 30-times faster than real time for datasets with 30 or more targets.

While the fusion performance results presented here are very encouraging, more testing, refinement, and optimization are needed before fusion of tracks from birds can be implemented into standard real-time use. Potential refinements will include additional algorithms such as smoothing filters applied to fused tracks, as well as performance trade-offs with other associated methods.

6.6 ADDITIONAL CRITERIA

6.6.1 Quantitative Performance Criteria

6.6.1.1 Reduce Compliance Costs [PE1.1]

Objective

The objective of Performance Criterion PE1.1, Reduce Compliance Cost is to evaluate whether the use of avian radar technology will produce a positive cost-benefit to DoD natural resource managers by reducing the cost of obtaining bird activity data for compliance with environmental regulations at their facilities. We set as our success criteria to demonstrate that the use of avian radar technology could result in an estimated 50% reduction in the cost of acquiring data for regulatory compliance.

It should be noted the other aspects of this criterion are discussed at length in Section 6.8, Cost Analysis.

Methods

We incorporated two potential scenarios to produce a structured cost-reduction analysis: Costs associated with implementing an improved sampling tool and costs associated with management of the data collected during the sampling process.

Improved Sampling Tool. We have demonstrated elsewhere in this report that the avian radars the IVAR project evaluated can, when compared to traditional methods of sampling bird populations, detect and track more targets, sample continuously 24/7, stream the data across both local- and wide-area networks, and display the track data both in a real-time COP or from the analysis of archived historical records covering diurnal, seasonal, and inter-annual periods, and wide geographic areas. Furthermore, they can accomplish these tasks while operating unattended. Given these advantages of avian radar technology, the question becomes: How do the costs of acquiring and operating these systems compare with the costs of traditional sampling methods that are currently being used?

To answer that question, we obtained from Dr. Timothy J. Nohara (personal communication) a working estimate of the cost to acquire and operate an avian radar system, based on ARTI's experience to date installing systems at SEA, NASWI, EAFB, Edisto Island, John F. Kennedy Airport in New York, and Chicago's O'Hare Airport. In addition, we obtained from discussion with DoD natural resources management personnel and contractors who work at various military airfields an estimate of the level-of-effort and average cost for conducting bird surveys manually.

Data Management. The avian radar systems evaluated by the IVAR project generate, for each update of each tracked target, digital records that include a wide range of parameters. Those data can be stored locally or remotely, in either files or a database, and can be accessed by a wide range of display and analysis tools supplied by the vendor or available from third parties (e.g., a GIS). We also demonstrated that these radar systems maintain a high degree of end-to-end data integrity and data quality when storing, transmitting, and redistributing these data. This capability leads to the second question: What is, or would be, the cost of maintaining this same data management and data quality levels for manually collected field measurements?

Many field observers still record their observations on hardcopy field data sheets because in many cases it is easier, faster, and more flexible. Processing the data typically requires transcribing the data to digital form, an additional and often error-prone process. Even when the field data are recorded digitally, they still need to be reformatted and metadata about the measurements need to be added for their eventual long-term (re)use. To address the effort involved in these processes, we relied on questionnaires previously sent to natural resource personnel to uncover typical avian data collection and management procedures.

Results

Improved Sampling Tool. As noted elsewhere, the avian radar systems we evaluated can sample bird populations continuously. To convert that effort into a cost, we used Dr. Nohara's estimate of \$500K to purchase, obtain an operating permit, choose a site, any necessary construction (e.g., concrete pad, lighting, utilities, computer network), operate, and maintain a system for one year. To this we added, based on ARTI's experience and on general industry averages, an estimated annual operating and maintenance cost of 20% of the start-up costs for the remaining four of the five years. These estimates yielded an overall 5-year cost for a system of:

$$\$500K + 4(20\% \times \$500k) = \$900K.$$

If operated continuously for five years, the aggregate cost of \$900K translates to an hourly rate of approximately \$20/hr. The comparable fully-burdened²⁵ labor rate for a senior biologist retained to conduct the bird counts manually would be on the order of \$100/hr - roughly five times the hourly rate for using the radar to do the sampling. Given the goal of a 10 hour/week sampling level-of-effort (Matt Klope, personal communication), the cost of using the biologists to make these observations over a five-year period would be \$260K. The cost of using the avian radar for the same level-of-effort would be \$52K – a savings of ~\$200K. The fact that the radar detects 50-times as many birds as the human observers for a given unit-of-time (Section 6.2.1.5) greatly increases this disparity on a cost-per-bird basis.

²⁵ “Fully-burdened” includes the cost of labor plus the cost of benefits, cost-of-living allowance, administrative costs, etc. We estimated the fully-burdened labor rate by using the salary of a GS-9/Step 1 civil servant, multiplying it by two to obtain a burdened rate, and then compared that estimate to the cost of an equivalent labor rate for a contractor using Independent Government Cost Estimate guidelines.

Of course, many other factors contribute to both sides of these simple cost and benefit computations. For example, the avian radar can sample at night (see Section 6.2.2.9), when visual sampling methods are inadequate. On the other hand, visual observers can sample in wooded areas and around large structures that could interfere with radar detections. Human observers can identify targets to species; the radar cannot. The radar can continuously track targets in 3D in real time throughout the sampling volume; the human observer cannot. Neither method is effective at sampling targets during heavy precipitation.

In fall 2008, Osmek et al. (2009) found that avian radar data statistically supported the SEA strategy of building stormwater ponds with bottom-liners and netting to mitigate the attractiveness of these sites to hazardous birds. Using 1,000 hrs of radar effort, these results indicate treated ponds were no more of an attractant, and in some instances less of an attractant, than mowed grass on the airfield or adjacent wooded areas. These findings help confirm that SEA need not spend the \$5 million to further treat these stormwater ponds with floating covers as had been suggested.

The relative importance of these different capabilities will vary based on the application: Identifying targets to species will be important when studying endangered species, while real-time tracking may be critical in locating travel corridors used by specific groups of birds. Continuous monitoring can also lead to cost avoidances, such as choosing among potential sites to locate wind turbines based on long-term bird activity patterns, and streaming track data to biologists in the field (see Section 6.3.1.4) enabling them to respond to an event as it is happening and before it become a greater hazard.

Data Management. Many of the same cost and benefit considerations apply to the management of the data generated by the automated avian radar system and the manual field observers. The radar data are generated, transmitted, and stored in a ready-to-used digital form²⁶, whereas the manually collected field data may have to be transcribed, augmented with metadata, and organized into data files or a database. While these data transcription and management tasks appear menial, they often require the original investigator (or someone of about the same pay grade) to interpret field notes, identify errors or inconsistencies in the data, etc. Past experience (Gerry Key, personal communication) has shown that every hour spent in the field recording observations manually requires at least one additional hour to process the data – thereby effectively doubling the cost per observation, or conversely, halving the time that can be spent in the field for a given project budget.

There are also numerous less-tangible benefits of continuous 24/7 data. Because the radar data are generated and stored in real time, the same data can be used for both immediate applications such as “sense & alert” (e.g., Section 6.3.1.5) as well as historical (seasonal or yearly) comparisons (e.g., Section 6.2.2.7). Because they sample day and night, digital avian radars are already leading to the discovery of activity patterns that were not be apparent otherwise, which in turn has lead new insights into the activity patterns at military facilities (Klope et al., 2009). Automatically retaining the radar track data in an organized, queryable database increases the opportunities for broader spatial and temporal perspectives of bird activity on military lands. Similarly, these systems can reduce “data loss” – not having the data to make comparison

²⁶The data generated by the Accipiter® DRP are in binary form, but the tools provided with the system (e.g., the TVW and TDV) can read these binary files and display them graphically or in numerical tabular form.

because no one was observing or the measurements that were made were not retained in a fully documented form.

Conclusion

We conclude from our analysis that automated digital avian radar systems can sample bird populations at a lower per-hour cost than human observers, perhaps as much as five-times lower. In addition, because the data are generated and stored in real time in a ready-to-use digital format, these avian radar systems can further reduce the lifecycle cost of maintaining, using and reusing the measurement data.

However, one should not conclude from these arguments that wildlife biologists can be replaced with avian radars. Radars are a sampling tool, and there are still many tasks the human observers can perform that the radar cannot. The optimum balance is to use avian radars for routine, surveillance sampling, which frees up the biologists and BASH managers to concentrate on what humans do best - interpret the radar data and follow the leads those data provide.

6.6.2 Qualitative Performance Criteria

6.6.2.1 Ease of Use [PE1.2]

Objective

Our objective in designing Performance Criterion PE1.2, Ease of Use, was to arrive at a qualitative assessment of how difficult it would be for potential users with no prior radar background or training to learn to use an avian radar system. We established as our success criterion that it was achievable that these users could learn to operate and/or use the avian radars systems evaluated by the IVAR project.

Methods

Two formal training sessions were held during the 3-year period of the IVAR project. The first was organized by the CEAT project and was held at the Port of Seattle (SEA) International Airport on 8-9 July 2008. This session provided an overview of radar systems in general and avian radar systems in particular, with the primary emphasis being how to configure and use the DRP and TVW user interfaces. The second training session was organized by ARTI at their facility in Fonthill, Ontario, Canada on 9-10 June 2009. The latter session was more directed toward the actual operational use of the Accipiter® avian radar systems. Neither of these sessions was organized by the IVAR project, but both were attended by members of the IVAR team. The instructors at both sessions were ARTI employees.

Results

Table 6-37 lists the number of participants who attended the two formal avian radar training sessions that were held during the course of the IVAR project. Of the 27 participants who attended the training sessions, eight attended both sessions.

Two of the participants (Drs. Gauthreaux and Beason) are expert radar ornithologists, but Dr. Beason and some of his USDA colleagues at MCASCP had much exposure the digital Accipiter® components before the IVAR project began. Likewise, three of the other participants were familiar with the analog BirdRad avian radars that had been installed at their facility: Only

one, Jim Swift, had been exposed to the eBirdRad system before the IVAR project, during the acceptance testing of eBirdRad at NASPR.

Apart from the formal sessions, numerous undocumented informal training sessions occurred throughout the course of the IVAR project. For example, a member of the ARTI staff was present at most of the visual confirmation studies (see Section 6.1.1.1.1), usually serving as a radar operator at least part of that time. Other participants in general, and the other radar operators in particular, were tutored by and learned from observing these radar professionals. Similarly, some members of the IVAR or CEAT staffs received informal training when an ARTI staff member visited a site to install a new component, or during a telephone (or email) support call.

Of the participants listed in **Table 6-37**, 14 have operated the eBirdRad or AR-x radars, and used DRP or TVW software to control the processing of the radar data from these systems, during the course of the IVAR project. Eleven of the participants use or have used the DRP or TVW software regularly, some daily. None of the personnel were trained to, nor were they required to, install, calibrate, or maintain the radar systems. All of the facilities with operating radar units used in this study had phone and email support from the vendor (ARTI), and those systems that had Internet connectivity could be operated and configured remotely.

Table 6-37. Number of participants attending formal avian radar trainings sessions during the course of the IVAR project.

Participant Affiliation	Training Session Dates	
	8-9 June 2008	9-10 July 2009
Air Force	1	2
CSC	1	
FAA	1	
Navy/Marine Corps	3	
Sea-Tac	1	1
University of Illinois/CEAT	6	9
USDA/WS	8	2
TOTAL	21	14

Most of the participants who attended the training sessions but did not become regular users attended to learn more about how avian radars work, their advantages and limitations, what sorts of data products are available from them, and how the technology might fit into their operational environment.

Conclusion

We have successfully demonstrated that individuals from a wide range of backgrounds but with no prior radar background or training can become proficient enough to operate and access the data from the avian radar systems evaluated by the IVAR project. This is an important result: It indicates that as these systems are brought online the natural resource managers and BASH

personnel can be trained to operate the systems themselves, without having to hire additional staff.

6.6.2.2 System Reliability [SE2.2]

Objective

We designed Performance Criterion SE2.2, System Reliability, to demonstrate that the avian radar systems being evaluated by the IVAR and CEAT projects could be operated continuously with minimal need for repairs

Methods

We chose to demonstrate Criterion SE2.2 using the frequency-of-repairs data gathered by the CEAT project because all of the units they deployed were purchased new, and thus would be more representative of the reliability of new units purchased by other users. The eBirdRad units at most of the IVAR locations were upgraded from existing BirdRad units with the addition of a DRP and associated hardware and software, while the RSTs and antennas of these units had been in the field for upwards of five years and had poorly documented repair histories prior to the start of the IVAR project.

Results

Avian radar systems were initially installed by the CEAT project at NASWI in March 2007 and SEA in July 2007. The radar systems have operated continuously since that time providing a robust and reliable operational history. The primary maintenance item in these systems is the magnetron. The manufacturer suggests replacement of magnetrons every 2000 to 3000 hours of operation. In these installations magnetron replacement has been necessary after 12,000 to 15,000 hours.

The mechanical elements of the scanner have operated continuously with no maintenance required (March 2007 and July 2007 through October 2010). Electronic components have also operated with no major maintenance required for the same time period. During this operation the radar systems have been managed by local wildlife personnel and a CEAT technical specialist and wildlife biologist who had experience as an electronics technician in the U. S. Navy.

Conclusion

The experience of the CEAT project has been that the avian radar system components run robustly under normal operating conditions and can be managed by military maintenance personnel. Further, life cycle requirements for the systems have not been established because all mechanical and electronic components have operated with little or no maintenance required since installation.

6.6.2.3 SAFETY RADIATION HAZARD [SE3.2]

Objective

X-band radars like those used in avian radar systems emit microwave radiation that can be hazardous to human health and can cause the detonation of materials such ordnance or fuels. We designed Performance Criterion SE3.2, Safety Radiation Hazard, to demonstrate that relatively straightforward procedures to reduce or eliminate these hazards can be achieved.

Methods

The US military²⁷ designates three categories of safety hazards from radio frequency (RF) radiation emitted by radars and other electronic devices:

- Hazards of Electromagnetic Radiation to Fuels (HERF) – fuel vapors ignited by RF-induced arcs.
- Hazards of Electromagnetic Radiation to Ordnance (HERO) – RF causing premature actuation of electro-explosive devices.
- Hazards of Electromagnetic Radiation to Personnel (HERP) – increases in overall body temperature or the temperature of specific organs, and shock or burns from RF-induced electrical currents or voltages in conductive objects.

To demonstrate SE3.2, we contacted personnel at each of the principal IVAR study locations to determine the procedures they followed to minimize the risk of these three hazards from the radar(s) operating at their locations. The results we present below from NAS Patuxent River are representative of the requirements at other military facilities, and in particular, military airfields.

Results

The following procedures apply to radars, including avian radars, located at land-based military facilities. At civil airports (e.g., SEA) the FAA procedures regarding minimizing radiation hazards cover similar considerations using different terminology, with two principal differences.

- Permission to operate any RF-emitting device at a military facility, including radars, must be obtained from the frequency coordinator for that facility. At civil airports (and elsewhere), the operator must apply for a license from the Federal Communications Commission (FCC) to operate an X-band radar on land.
- Conditions involving ordnance (i.e., HERO) would not normally be a concern at civil airports.

The primary consideration regarding potential RF hazards from avian radars on military lands is the radar's location: Where is the radar in relation to the people and explosives it might affect? Once the proposed location(s) of the radar is (are) known, those hazards can be evaluated.

Before they received their BirdRad radar at NASPR, the Natural Resources staff submitted a request to the Air Operations. Based on that request, Air Operations personnel calculated the HERF, HERO, and HERP distances for a 50 kW X-band radar and determined in what zone the radar would be located. Air Operations also set conditions under which the radar would need to be "silenced" (i.e., in Standby mode) for specific airfield conditions. For example, if HERO Condition #2 was set for the airfield and the radar was in one of the affected zones, the Natural Resources staff is required to shut down the radar until that HERO condition is lifted.

Once this review was complete, Air Operations added the Natural Resources staff to the HERO "phone tree" so that someone would notify the Natural Resources staff anytime the HERO condition on the airfield changed. Air Operations also requires that the Natural Resources staff to have a base radio with them whenever they are at the trailer operating the radar, again in case the HERO condition on the airfield changes.

²⁷ See for example <http://safetycenter.navy.mil/acquisition/RFR/index.asp>

Once those determinations had been made by Air Operations, the Natural Resources staff used these and other criteria (e.g., concrete pad, access to shore power, etc.) to select the location for the BirdRad radar at NASPR – and thus the location for the eBirdRad unit, which was an in-place upgrade that used the same radar transceiver. **Figure 6-124** is a copy of the letter the Natural Resources staff prepared for Air Operations, confirming the location and conditions for operating the [e]BirdRad radar.



Natural Resources Branch
22541 Johnson Road, Building 1410
Naval Air Station
Patuxent River, MD 20670-1700



22 May 2002

MEMORANDUM

From: Natural Resources Manager
To: Air Operations Deputy/GE, Mr. Ray Cameron
Subj: MOBILE BASH FURUNO RADAR (BIRD RAD)

1. The Natural Resources Office, as part of the Station's Bird Aircraft Strike Hazard (BASH) reduction program, purchased a radar system known as BIRD RAD. BIRD RAD is a modified Furuno Radar system used for locating and tracking bird movement patterns on and around the Station's airfield. This is a new technology and requires testing. The Natural Resources Office is requesting your authorization to begin testing of its BIRD RAD system. Testing would begin as soon as authorization is granted, and will continue through 31 August 2002.
2. Mr. Tom Dealy and NSWC Dahlgren have reviewed the radar system for HERO SUSCEPTIBLE AND UNSAFE distances. A distance of 40 feet (12 meters) will be maintained for HERO UNSAFE ORDNANCE and 29 feet (9 meters) for HERO SUSCEPTIBLE ORDNANCE conditions. The Natural Resources Office, prior to activating the radar system, will call flight planning to get the current HERO condition. BIRD RAD will only be operated in zone 5. Anytime the HERO condition is set at 7 (HERO susceptible) or 5 (HERO unsafe) within zone 5, BIRD RAD will be shut down. Personnel working BIRD RAD will be in radio contact with the tower at all times while on the airfield, and will use the call-sign "BASH 1". The tower will contact BASH 1 via radio if the HERO condition changes while BIRD RAD is operating.
3. Mr. Dealy has also reviewed and approved the proposed airfield location, near the mid-field laser site. The Natural Resources Office is looking into other testing locations and will coordinate with Mr. Dealy prior to moving BIRD RAD to any other locations.
4. Please acknowledge your concurrence and any conditions by signing the bottom of this memo. Direct any questions regarding BIRD RAD to Mr. Jim Swift at 7-0006 or 2-3670.

Kyle E. Rambo
Natural Resources Manager

Signature and Date:

Figure 6-124. Letter from NAS Patuxent River Natural Resources Manager to Air Operations confirming the location and conditions for operating the BirdRad (and later eBirdRad) avian radar.

The following are specific considerations regarding minimizing HERF, HERO, and HERP conditions. It should be noted that the ability to remotely control the operation of the radar (see Section 6.2.2.3) is particularly beneficial in this regard.

Hazards of Electromagnetic Radiation to Fuels (HERF)

The greatest risk of HERF conditions at an airfield occurs during refueling operations, which are typically conducted at fixed locations. Once the type of radar transceiver is known, Air Operations can calculate the safe operating distance for HERF conditions.

Hazards of Electromagnetic Radiation to Ordnance (HERO)

Much like refueling sites, ordnance storage is usually at fixed locations; thus, the safe operating distances for the radar can be calculated much like those for HERF. Those safe operating distances can, however, change when ordnance is transported to and from these storage locations, or when they are loaded onto an operating aircraft. For this reason, procedures such as those described above and in **Figure 6-124** are established to ensure that the radar is silenced when HERO conditions warrant.

Hazards of Electromagnetic Radiation to Personnel (HERP)

As with HERF and HERO, Air Operations calculates the safe distances for HERP relative to those areas where people work, congregate, or transit. However, HERP has the added dimension that the Natural Resources staff must at times work in or near the radar trailer. Likewise, other personnel who approach the radar trailers need be alerted to the potential danger from RF radiation. For these reasons, the IVAR project made its own determination of safe distances for personnel approaching the avian radars used in these studies.

The US Occupational Safety and Health Administration (OSHA) has established that the maximum safe level of exposure of humans to microwave (RF) radiation is $0.2\text{mW}/\text{cm}^2$. They have further determined that the average intensity of a rotating X-band marine radar operating at the same height as the subject drops below this level at a distance of 2-3 m.

Within these general guidelines, a variety of factors influence the distance at which a person would be exposed to these levels of RF radiation from the radars operated as part of the IVAR project. These factors include:

- The peak power output of the radar; some in the IVAR studies were 50 kW, others were 25 kW.
- Whether the transceiver is mounted on top of the trailer, or on a cart close to the ground. This factor determines how far from the transceiver the main radar beam would intersect a person standing on the ground.
- Whether the antenna type is a dish or an array. Dish (i.e., parabolic) antennas have a narrower, focused beam (e.g., 4° on the eBirdRad units) and are usually elevated at an angle (e.g., 5° - 7°) above the horizontal. Array antennas have a wider beam (e.g., 10° above and below horizontal for the AR-1 radars) and are not angled above the horizontal.
- Whether the antenna is rotating or “staring” (i.e., transmitting but not rotating). The CEAT project used radars in staring mode for some short-duration calibration studies; all of the demonstrations described in this report used rotating antennas.

Given these considerations, the IVAR and CEAT projects adopted a more conservative value of 10 m or more as the safe distances between project personnel and a transceiver with a rotating antenna. Project personnel place orange safety cones around the radars as illustrated in **Figure 6-125** to demarcate this 10 m (or greater) safe HERP distance. All personnel who worked at or near the operating radars were instructed to always assume a rotating antenna is transmitting and to maintain a minimum of 10 m distance from a transceiver, except when entering or exiting a trailer with a roof-mounted transceiver.



Figure 6-125. eBirdRad avian radar at NAS Whidbey Island, showing orange safety cones used to indicate to personnel the safe distance to approach the radar when it is operating.

The older eBirdRad radars have their transceiver mounted on a cart (see Section 2.4.2). The main radar beam is consequently emitted closer to the ground than those of transceivers that are roof-mounted. The cart-mounted transceivers are, however, connected to the trailer by a 50 ft. (15 m) umbilical cable; thus, when deployed the transceiver is more than 10 m from any personnel working in or near the trailer. **Figure 6-126** illustrates the placement of orange safety cones around the eBirdRad cart at EAFB. This was a temporary location for the eBirdRad, before the transceiver was mounted on the roof of the Operations Building (in background) for the IVAR studies. The safety cones, which are less than 10 m from the cart, are there to warn pedestrians of the obstruction on the sidewalk.



Figure 6-126. eBirdRad unit at Elmendorf Air Force Base in April 2008, prior to mounting the transceiver on the roof of the Operations Building in the background.

Conclusion

We have successfully demonstrated the safe operating distances for HERF, HERO, and HERP conditions are calculated for all radars, including avian radars, as part of the standard process of locating a radar at a military facility. We have further demonstrated that additional precautions for personnel working at or near these radars are easily established.

6.6.2.4 Maintenance [SE4.2]

Objective

Performance Criterion SE4.2 is a companion demonstration to Criterion SE2.2 (Section 6.6.2.2). Whereas SE2.2 examined how reliable the evaluated avian radar systems are, SE4.2 examines how well the systems can be maintained by onsite personnel.

Methods

As with Criterion SE2.2, we chose to evaluate the question of local maintenance using the three years' worth of data gathered by the CEAT project for their newly installed units.

Results

No maintenance was required on the mechanical, electrical, or electronic components of the CEAT avian radar units during the period March 2007 through March 2010.

The magnetron of the older eBirdRad unit at NAS Whidbey Island had to be returned to the manufacturer (Furuno) for replacement shortly after the Fall 2008 IVAR study there. In that case, the wildlife biologist at NASWI and a CEAT technical specialist working there, himself also a wildlife biologist with experience as an electronics technician in the U. S. Navy, were able to dismount and disconnect the RST from the eBirdRad trailer, return it to Furuno technical services in southwest Washington state, and remount and reconnect the unit after it was repaired. Over the course of the three-year IVAR project, the following components of the Furuno 2155BB marine radar at MCAS Cherry Point (also one of the older eBirdRad units) had to be replaced or repaired: A magnetron, an antenna motor, and a circuit board. The antenna motor was removed and replaced by the WS wildlife biologist but the other repairs were performed by a local certified Furuno technician.

As regarding diagnosing and correcting some equipment problems, one of the advantages of having remote connectivity to the avian radar systems in the field is that the vendor's (in this case, Accipiter®) technical staff can use that connection to assist local personnel in the diagnosis of problems, as well as uploading and installing routine software upgrades, bug-fixes, etc.

It should also be noted there is likely to be no shortage of qualified radar and electronics technicians at most military bases, particularly airfields. Thus, even if the end-users of the avian radar systems may not have the requisite technical skills to perform simple maintenance tasks, others at the facility may well have those skills. We've also observed over the years that both military and civilian technicians at these facilities become quite interested in the avian radar technology and are most anxious to assist when called upon.

Conclusion

Local personnel have been able to maintain the avian radar systems in the field during the course of the IVAR and CEAT projects. When a major repair was required, local personnel were able to remove the failed component, return it to the manufacturer for repair, and reinstall the repaired component.

6.7 OTHER AVIAN RADAR SYSTEMS

The IVAR and CEAT studies employed digital avian radar systems provided by Accipiter Radar Technologies Inc. (ARTI). There are other avian radar systems on the market, but these systems were not tested as part of our projects. These commercially-available systems include:

- Accipiter® systems from ARTI, - www.accipiterradar.com
- MERLIN™ systems from DeTect, Inc. - www.detect-inc.com
- MARS® system from GeoMarine, Inc (GMI) - www.geo-marine.com
- ROBIN Lite system from TNO (now Robin Radar Systems b.v.) - www.vogelradar.nl

It is only possible to make general comparisons between these systems at this time because the other commercially available radars have not undergone comparison testing, nor have independent performance assessments been completed by the FAA or other agencies. Instead,

the comparative information presented here has been provided by the University of Illinois CEAT project, an IVAR partner.

The information used in these general comparisons comes from some performance assessments, as well as information from publicly available sources and extensive experience gained by CEAT personnel in formal manufacturer training and/or operation of radar sensors and systems. CEAT experience includes the management of the deployment of ARTI-based avian radar systems at the Seattle Tacoma International Airport (July 2007), Naval Air Station Whidbey Island (March 2007), O'Hare International Airport (October 2009) and John F. Kennedy International Airport (January 2010). CEAT is also managing the deployment of the GMI MARS® system at the Dallas Fort Worth International Airport, which is expected to be operational in early 2011. CEAT personnel have received formal training in the operation of ARTI radars and have completed formal training conducted by DeTect, Inc. on the MERLIN™ system. In addition, CEAT has conducted a detailed technology assessment of the Robin Radar Systems b.v. commercial technologies and is involved in a cooperative assessment of Robin radars as these radars are deployed to commercial airports. CEAT has also acquired, and is presently testing X-band and S-band marine radars from Japan Radar Corporation and solid state marine radars from Kelvin Hughes. For both of these manufacturers, CEAT staff has received formal manufacturer training in the use of these radars.

To provide a comprehensive comparison this section will discuss components of avian radars that include radar transceiver manufacturer, antenna type and configuration, digital processing, plot and track generation, data display, and data management/information system configuration. **Table 6-38a** and **b** provides a tabular summary of the capabilities of COTS avian radar systems.

Transceivers – In general, all commercially-available avian radars systems we examined use commercial off-the-shelf (COTS) transceivers from marine radar manufacturers. The exception is the ROBIN system that integrates an S-band marine radar in a horizontal scan that is coupled with a frequency modulated-continuous wave (FMCW) radar that is designed to acquire and track targets in 3D identified in the horizontal scan. The primary manufacturers of marine radars used by avian radar companies include Furuno Electric Company Ltd (Furuno) and Japan Radio Corporation (JRC). The Furuno and JRC systems use conventional magnetrons to generate their transmitted waveforms. Recently, a manufacturer in the United Kingdom, Kelvin Hughes Ltd. (KH), introduced a line of solid-state marine radars that are being integrated into new avian radar systems by DeTect and ARTI. These transceivers digitally generate their transmitted waveforms.

Two frequency bands, S-band (10 cm wavelength) and X-band (3 cm wavelength) are commonly used with power in the 10 to 50 kW range.

The IVAR project utilized two Furuno radar models. The eBirdRad, a derivative of the BirdRad initially deployed in 2001 in the Legacy Program utilized a Furuno 2155BB X-band 50 kW transceiver. The radars deployed by CEAT and used in the IVAR project utilized the Furuno 8252, X-band 25 kW transceiver.

CEAT has deployed and operated Furuno X-band transceivers at NAS Whidbey Island (NASWI), Seattle Tacoma International Airport (SEA), O'Hare International Airport (ORD), and John F. Kennedy International Airport (JFK). The NASWI system has been in continuous operation since March 2007, SEA since July 2007, ORD since October 2009 and JFK since January 2010. In addition to the Furuno transceivers provided in ARTI systems, CEAT has

acquired and is testing JRC S-band and X-band radars, and KH S-band and X-band radars. Although GMI has deployed MARS® radars for some time in Scotland and DeTect has multiple radars deployed at military and commercial airports worldwide, no detailed data are available from these deployments.

Antenna Type and Configuration – There are two general antenna types used on avian radar systems: a parabolic dish and a slotted-array. The eBirdRad system used in the IVAR project was outfitted with a 4° parabolic dish antenna. The ARTI radars deployed by CEAT were equipped with either a 4° parabolic dish manufactured by ARTI or a nominal 20° (vertical) by 1.2° (horizontal) standard Furuno slotted-array antenna. DeTect, GMI, and TNO systems typically use standard COTS slotted array marine radar antennas. The Robin FMCW uses a specialized antenna configured from two Furuno slotted array antennas.

Slotted array antennas can be mounted in a horizontally-spinning configuration or rotated 90° in a vertically-spinning configuration. Dish antennas spin horizontally, but can be tilted up to a desired angle between 0° and 90° above the horizon.

Digital Processing – The COTS transceivers used in avian radars produce an analog signal that must be converted to a digital signal for further processing. The avian radar manufacturers use a combination of COTS and proprietary radar interfaces and digitizing technologies. Digital processing includes a variety of specialized algorithms including video processing, clutter suppression, detection, and tracking. These functions and their algorithms are proprietary to avian radar manufacturers, differ considerably, and represent the system logic that extracts and separates bird targets from other targets detected by the radar. They provide a key basis for the comparison of the performance of avian radars.

This processing is performed in a radar digital processing system (RDPS; the “DRP” of the ARTI systems discussed above) that is unique to each manufacturer. It is in the RDPS that the intellectual property of the manufacturers is most evident. Data output from the RDPS will be some form of automatically generated target information including position, velocity, and intensity/radar cross-section (RCS) information, depending on the avian radar and the antenna(s) used.

While detection and track generation should be the focus for comparisons among avian radar systems, it is not possible at this time because of proprietary commercial interests.

Data Display – There is a general uniformity to the format of radar displays generated from a horizontally-spinning radar antenna. The plan view or standard radar plan position indicator (PPI) display is usually provided in either radar coordinates (i.e., a polar reference), earth coordinates, or both. Digital processing supports the translation from polar to geographic coordinate systems allowing the display to show the radar output superimposed on maps or aerial photographs of the area of coverage. Display layers differ from manufacturer to manufacturer and can include input video, clutter-filtered video, echo trails mode, detections, and tracks, along with an underlying map and a variety of symbolic and marker overlays.

Data Management – Data management in avian radar systems includes management of the digitized, analog video signal (“video data”) received from the radar sensor, and management of the processed target data generated as continuously storable output by the RDPS. In general, the video data is voluminous and complete archives of video data are problematic. All systems have the capability of recording video data of some form, at least for short durations. Radar video

data are available in standard formats from digitizing systems or the RDPS itself. B-scan video data are the rawest form, which retains the received range, azimuth, and intensity information from the radar transceiver; while scan-converted video data results from a lossy data transformation to an X/Y coordinate system with intensity. Recording either B-scan video or scan-converted video data is a common capability in avian radar systems to facilitate reprocessing or reanalysis of archived data. ARTI systems use advanced compression algorithms to archive raw B-scan video data, which allows comprehensive reprocessing of the archived data with the RDPS.

The (bird) target data continuously stored by the RDPS differs based on proprietary processing of each radar system. Target data can be stored in time-organized files (for easy replay/analysis capabilities), in a database format for arbitrary queries, or both. Vendor software can be used to access target data stored in files, and database management tools can be used to access target data stored in a database. Two general types of target data are stored: plot data (i.e., detections) and track data (which are formed from plots). Track data are provided by most vendors and can be readily reanalyzed. ARTI also continuously stores plot data that can be reprocessed by the RDPS. For example, it can redo tracking after the fact to extract other targets of interest (e.g., aircraft) or to re-optimize the tracking. In addition, ARTI supports reanalysis of RDPS output using a Track Viewer Workstation that can set different criteria for track display and allow definition of regions for detailed track analysis. General data management capabilities for avian radars have been defined in the recently issued FAA Airport Avian Radar Systems Advisory Circular No. 150/5220-25, which provides requirements and standards for data management in all avian radar systems purchased with federal funds.

Data Streaming – As defined in this report, data streaming is the process of sending digital target data from where the data are generated (i.e., the avian radar) to where the data will be used (e.g., wildlife management office) or where it will be stored (a centralized historical database) in real-time. In comparison to video data, target data are low bandwidth and hence sending this information over 3G wireless networks, or using DSL or cable modems to send target data over the Internet is feasible. Data streaming in avian radar systems is primarily limited by vendor data management and signaling schemes data rate (or bandwidth requirements), and connection speed. ARTI radar systems have been shown herein to provide the full spectrum of data streaming with data integrity and real-time confirmation over standard commercial networks including the Internet.

Data Integration and Data Fusion – Data integration and data fusion both involve combining track data from two or more radars into a single display in real time. For data integration, the radars may or may not have overlapping coverages and they may be closely or widely separated. Data integration can increase situational awareness by presenting the operator with a larger coverage area, and potentially more targets within that area, in a single display. As more radars are used to increase coverage, a single integrated display becomes a highly-desirable feature to enhance awareness for operators.

Data fusion requires radars to be spaced close enough that their beams overlap for some portion of their coverages and targets within the areas of overlap are tracked simultaneously by the separate radars. Fusion can occur locally or the data from the separate radars may be streamed to a remote data fusion processor. Data fusion requires more precise spatial and temporal alignment of the radars than data integration, as well as algorithms capable of determining in real-time when tracks from the separate radars are the same target moving into and out of the

areas of overlap. Data fusion algorithms typically replace the tracks from the separate radars with master or common tracks that have a greater extent across the coverage area. Thus, data fusion not only increases coverage, it also increases track continuity and quality.

CEAT undertook an examination of data integration and data fusion capabilities of the Accipiter®, MARS®, and Merlin™ avian radar systems. That comparison found limited data integration and no data fusion capabilities in the MARS® and Merlin™ systems at that time, but the current integration and fusion capabilities of these vendors are unknown. Data integration was demonstrated on the Accipiter® systems, displaying data from multiple radar systems simultaneously in a Google Earth environment. Integration was also demonstrated for the dual-sensor, co-located AR-2 system at SEA, where detections from different altitudes are simultaneously displayed. CEAT conducted fusion experiments in cooperation with ARTI using the multiple radar installation at NASWI. In those fusion experiments, location information for each sensor was confirmed, and target location validated by observation.

Table 6-38a. Configurations of commercial digital avian radar systems: Sensors, Antennas, Digital Processors

Vendor	Model	Sensor			Antenna	Radar Digital Processing Systems				
		Mfr	Type	Freq		Digitizer	Digitizer Output	Video Data Storage	Processor	Form
Conventional Marine Radar	Various	Furuno, JRC, Kelvin Hughes	Magnetron, solid-state	X- & S-band	Horizontal Arrays	Embedded	Embedded	N/A	Embedded	Embedded
ARTI ^(a)	AR-1 ^(b) , AR-2	Furuno, JRC, Kelvin Hughes, other	Magnetron, solid-state	X- & S-band	Dish, horizontal & vertical arrays	Rutter	B-scan	B-scan	Proprietary	Embedded PC
GMI	MARS	Furuno	Magnetron	X- & S-band	Horizontal & vertical Arrays	Rutter	Scan converted	Unknown	Proprietary	PC
DeTect	Merlin	Furuno, JRC, Kelvin Hughes	Magnetron, solid-state	X- & S-band	Horizontal & vertical arrays	Rutter	Scan converted	Unknown	Proprietary	PC
TNO	ROBIN	Furuno, TNO	Magnetron, solid-state	X- & S-band	Horizontal array & FMCW tracking antenna	TNO	Unknown	Unknown	Proprietary	PC

NOTES:

(a) The IVAR and CEAT projects evaluated ARTI avian radar systems that used X-band Furuno sensors with magnetrons, and dish and horizontal array antennas.

(b) The eBirdRad avian radar system evaluated by the IVAR project is equivalent to an ARTI (Accipiter®) Model AR-1.

Table 6-38b. Configurations of commercial digital avian radar systems: Data Management, Connectivity, Data Streaming, Integration and fusion.

Vendor	Model	Data Management			Remote Connectivity	Data Streaming	Data Integration	Data Fusion
		Continuous Data Output & Storage	Review, Replay, Reprocess	Archive Type				
Conventional Marine Radar	Various	None – Display only	N/A	N/A	No	N/A	N/A	N/A
ARTI ^a	AR-1 ^b , AR-2	Plots & tracks and scan-converted PPI Image	Yes/Yes/Yes	Digital	Yes	Yes	Yes	Yes
GMI	MARS	Tracks	Yes/Unknown/Unknown	Digital	Yes	Unknown	Unknown	Unknown
DeTect	Merlin	Tracks	Yes/Unknown/Unknown	Digital	Yes	Unknown	Unknown	Unknown
TNO	ROBIN	Tracks	Yes/Unknown/Unknown	Digital	Yes	Unknown	Unknown	Unknown

NOTES:

See Table 6-38a for footnotes.

6.8 FUNCTIONAL REQUIREMENTS AND PERFORMANCE SPECIFICATIONS

During the course of the demonstrations described above, the companion document *Functional Requirements and Performance Specifications for Avian Radar Systems, Integration and Validation of Avian Radars (IVAR)* (Brand et al., 2011) was prepared by the IVAR project team to document the functions a modern digital avian radar system should be capable of performing and the levels at which these systems should be capable of performing these functions. The goal of presenting these functions and performance specifications in a separate document is twofold: First, to use them as a starting point for anyone interested in acquiring and deploying avian radar technology; second, as a starting point for updating the capabilities and performance of avian radar systems as existing systems evolve and as new systems come into the marketplace.

7 COST ASSESSMENT

Along with demonstrating and validating the application of radar systems at a number of sites, an important goal of this project was to develop and validate, to the extent possible, the expected operational costs of the technologies. Relevant costs and related data as described in this section are listed and documented during the IVAR demonstrations so that the operational costs of the technology can be estimated with a high degree of validity.

In addition to data gathered from the IVAR demonstrations, NRM user requirements also contributed to this section. These requests helped develop the current Accipiter® system and its components. The user requirements derived from these requests are discussed in Section 2.2.

7.1 COST MODEL

The Cost Models presented in **Table 7-1** through **Table 7-3** list the estimated cost of the technology and methodology tracked throughout the IVAR project. The tables present three system configurations: Standalone, Integrated, and Advanced. A Standalone system includes components that are necessary for the end-user to track and view avian targets. An Integrated system includes additional products that allow a user to remotely collect, view, store, and track these targets, and to remotely control the system. An Advanced system includes additional components that support viewing the data from multiple systems on a single, fused display.

The capital costs of avian radar systems differ significantly depending upon a number of factors discussed below. The estimates provided in this section are based on actual experiences during the IVAR and CEAT projects, as well as publicly available data, with a view towards generalizing them so that they might be applicable to products offered from a number of commercial vendors. All costs are reported in US Dollars.

In its simplest form, an avian radar operates as a Standalone system (**Table 7-1**), which allows a user to obtain and record plot and track data from the Avian Radar System, and to replay and extract those data for analysis. It consists of a COTS marine radar transceiver and antenna, combined with a digital processor that generates detections and tracks (referred to as “target information”). For airport use, the radar transceiver and antenna (i.e., the radar sensor) is typically mounted on a wheeled trailer, on a roof-top, or a small tower structure. The digital components could be mounted in the trailer or indoors. A local operator would run the radar, or would visit it periodically to collect recorded target information. Data collection is the result of the digital processor software processing the radar signals received from the transceiver. Playback of the digitized data and their analysis is accomplished on the TrackViewer workstation – typically, a laptop computer. The range of purchase costs is determined by whether an existing structure is used for the installation, a new structure is built, or a trailer is used; whether utilities are available, must be installed, or the system is to be powered by a generator; and which radar sensor is selected. The cost of commissioning a Standalone system is greater than for the other two configurations because the lack of network connectivity requires that all activities must be done on-site.

Table 7-1. Cost Model for a Standalone Avian Radar System.

Cost Category	Sub-Category	Standalone System	Estimated Cost
Radar System	Transceiver & Antenna	X	\$250K – \$350K
	Digital Processor	X	
	Remote Workstation	X	
	Network Connectivity		
	Remote Controller		
	Data Server		
	Data Fusion Processor		
	Statistical Processor		
	Permanent Structure	X	
	Portable Trailer	X	
Installation	Site Assessment	X	\$20K – \$30K
	Licensing	X	\$5K
	Site Preparation	X	\$1K – \$5K
	Wireless ISP/Point to Point Link		
Operation & Maintenance	Training	X	\$5 – \$7K
	Commissioning	X	
	System Monitoring/Technical Support	X	\$30K – \$60K per year (typical)
	Repairs/Replacements	X	
	Network Data Charges		
	Utilities	X	\$1K per year
System Lifetime	5 to 7 years		\$406K – \$764K ²⁸

The Integrated system configuration (**Table 7-2**) is based on the Standalone configuration (**Table 7-1**) with added capabilities made possible with network connectivity. Network connectivity can be a wired or wireless connection to the Internet or to a restricted LAN. It provides the operator the ability to remotely control the radar; it also enables the digital processor to send plots and tracks data to a data server, which in turn can distribute those data to multiple users in their office, vehicle, or at a remote site. The data server abstracts the radar from the users, allowing them to think only of real-time and historical target information in earth coordinates. With the Integrated configuration, each user can receive the data from any of the radar systems served by the data server and would have a TrackViewer workstation configured for a specific use (wildlife management, air traffic control, etc.). Support may also be provided for integrating the target information from multiple radars (either co-located or widely separated) to increase coverage and provide a single integrated display for users. The higher purchase cost of the Integrated

²⁸ The first year’s annual System Monitoring and Repairs costs are covered under warranty and included in the purchase price. Thus, the estimated System Lifetime costs are equal to the (sum of the fixed costs) + ([years-1] X the annual Monitoring & Repairs costs) + ([years] X sum of the other annual costs), where “[years]” = 5 or 7 for the projected minimum and maximum system lifetimes, respectively.

configuration is due largely to the addition of the network and data server components; training and commissioning costs are about half over those for the Standalone system because support can be provided remotely by the vendor.

Table 7-2. Cost Model for an Integrated Avian Radar System.

Cost Category	Sub-Category	Standalone System	Estimated Cost
Radar System	Transceiver & Antenna	X	\$400K – \$500K
	Digital Processor	X	
	Remote Workstation	X	
	Network Connectivity	X	
	Remote Controller	X	
	Data Server	X	
	Data Fusion Processor		
	Statistical Processor		
	Permanent Structure	X	
	Portable Trailer	X	
Installation	Site Assessment	X	\$20K to \$30K
	Licensing	X	\$5K
	Site Preparation	X	\$1K – \$5K
	Wireless ISP/Point to Point Link	X	\$0.5K – \$1.0K
Operation & Maintenance	Training	X	\$2 – \$5K
	Commissioning	X	
	System Monitoring/Technical Support	X	\$40K – \$100K per year (typical)
	Repairs/Replacements	X	
	Network Data Charges	X	\$0.2K – \$1.5K per year
	Utilities	X	\$1K per year
System Lifetime	5 to 7 years		\$594K – \$ 1,164K ²⁸

In an Advanced configuration (**Table 7-3**), additional post-processors may be present that receive data from the data server as described under the Integrated Avian Radar System (**Table 7-2**). The data fusion processor takes outputs from multiple radar systems and fuses the data into a single display. These data can be presented in real-time (updated approximately every 2.5 sec) or the historical data from multiple radars can be synchronized and played back using the TrackViewer laptop. Statistical analyses can be performed on real-time or historical data as the data are available; for example, the number of tracks for the past hour, number of tracks/hour for the past day, altitudinal distribution of tracks for the past hour (or other time interval), mean direction of movement, distribution of size classes of targets, etc. These data can be displayed alone, in conjunction with a single radar’s display, or the fused display of all the radars. These

additional processors account of the higher purchase price of the Advanced over the Integrated system.

Table 7-3. Cost Model for an Advanced Avian Radar System.

Cost Category	Sub-Category	Standalone System	Estimated Cost
Radar System	Transceiver & Antenna	X	\$500K – \$750K
	Digital Processor	X	
	Remote Workstation	X	
	Network Connectivity	X	
	Remote Controller	X	
	Data Server	X	
	Data Fusion Processor	X	
	Statistical Processor	X	
	Permanent Structure	X	
	Portable Trailer	X	
Installation	Site Assessment	X	\$20K to \$30K
	Licensing	X	\$5K
	Site Preparation	X	\$1K – \$5K
	Wireless ISP/Point to Point Link	X	\$0.5K – \$1.0K
Operation & Maintenance	Training	X	\$2 – \$5K
	Commissioning	X	
	System Monitoring/Technical Support	X	\$50K – \$150K per year (typical)
	Repairs/Replacements	X	
	Network Data Charges	X	\$0.2K – \$1.5K per year
	Utilities	X	\$1K per year
System Lifetime	5 to 7 years		\$734K – \$ 1,714K ²⁸

Given this breadth of variation, the acquisition cost of an avian radar system can vary from \$250,000 to \$750,000. Depending on the components and options selected, one could pay \$750,000 for a single radar transceiver with advanced components, or could pay less for a dual-radar system (e.g., a collocated, trailer mounted radar with two transceivers and antennas) with fewer options. The key to getting good value is to develop a sound understanding of the facility’s present and likely future requirements before making a purchase. A radar site assessment can also greatly assist in this regard as it will provide the necessary performance data to trade-off design options, maximizing value for the least cost.

Transceiver and Antenna – The radar sensor usually consists of a COTS marine radar transceiver combined with a radar antenna. Antenna types include array, dish, and custom, with the cost and performance of the antenna typically increasing in that same order. Transceivers come in two frequency bands: X-band and S-band. For the similar size and weight, X-band

antennas typically provides three times the spatial resolution as S-band. For the same resolution, a S-band antenna is typically three times larger. Transceivers are available in both conventional magnetron or solid-state varieties, with different cost/maintenance trade-offs. Solid-state systems are purported to have much longer times between scheduled maintenance but cost about 10X more than magnetron-based systems. Both are built to the International Maritime Organization (IMO) standards and are type compatible. The cost of marine radars varies considerably depending on the frequency band, transmitter type, and performance.

Digital Processor – The digital processor includes a radar interface board that connects to the transceiver and digitizes its analog radar signal. The digital processor also carries out digital signal processing including scan-conversion and video display, detection, and tracking. The track information produced by the digital processor can include latitude, longitude, altitude, speed, heading, and intensity or radar cross-section (RCS) for every target in the 360° coverage volume, updated every few seconds.

TrackViewer Workstation – The workstation is a laptop computer with TrackViewer and Track Data Viewer software installed. In addition to displaying real time and historical plots and track data, the TrackViewer software has optional capabilities to generate analytical products such as Histories described in Section 6.2.1.1

Network Connectivity – If target information is to be accessible by remote users, and if the radar is to be controlled remotely, a network connection to the digital processor and the transceiver is needed. Remote support therefore requires a gateway to the Internet.

Remote Controller – This device turns the COTS transceiver into an IP device that can be controlled remotely over the LAN or Internet. The radar can be remotely powered on or off, diagnostics can be accessed, waveforms can be selected, etc.

Data Server – This device turns one or more radars into an information system that simultaneously supports multiple remote users with user-specific real-time and historical information. It supports integration to third party applications and provides an avian radar installation with scalability and flexibility.

Data Fusion Processor – This device joins and smoothes tracks from adjacent radars belonging to the same target, improving information quality.

Statistical Processor – This device processes target information to provide statistical patterns associated with bird behavior in the sampled airspace. Track counts, densities, BASH condition alerts, height distributions, flow patterns, etc. can be analyzed spatially and temporally to provide situational awareness.

Permanent Structure – In situations where the location of a radar is known and expected to be fixed (e.g., a roof-top or fixed ground location), a permanent installation for the radar can be most cost effective. For a roof-top installation, the digital equipment can be mounted inside the structure. For a ground location, the equipment can be located in an equipment shack.

Portable Trailer – In some cases, it is more convenient for a facility to have the radar self-contained within a trailer or similar structure that provides space for human activities such as support and maintenance. Trailers can range from those with minimal human considerations to those with considerable comfort. The environmental controls of the trailer must be able to maintain the equipment within its safe operating temperature range.

Installation

Site Assessment – Radar performance is strongly affected by its local surroundings. Clutter (from land, sea, trees, buildings, etc.) limits its ability to detect birds and can obstruct the radar’s view. Aircraft, buildings, and fences can cause multiple reflections (called “multipath”) that can confuse the radar user. These effects can be mitigated by a careful selection of the site, height, and type radar antenna. A site assessment using a radar system will measure these effects by generating local clutter maps and generate bird and aircraft track histories to determine effective coverage. Usually, after initial consultation with an avian radar vendor to establish requirements, the facility will identify two or more sites where it would be logistically possible to locate the radar. The radar vendor would then carry out the site assessment and report on its findings. This would typically involve about a week of radar operation followed by subsequent analysis and reporting.

Licensing – Licensing for use at a civil airport will first require Federal Communications Commission (FCC) licensing. The most efficient way to obtain the license is to work through a consultant who will prepare and file the needed forms with the FCC and FAA. A reasonable cost estimate for obtaining an FCC license is \$5,000, although this cost could be reduced by obtaining a CONUS operational permit if long-term use is intended for multiple locations.

For military installations there is a similar frequency clearance process but it is local. The military frequency clearance process appears to be an overhead/approval cost common to any activity on the installation.

FAA Form 7460 - Placement of any object or facility on an airport will require approval from the FAA. The primary approval mechanism is completion of a Form 7460 that is reviewed for obstructions and provides a frequency clearance for any active radio frequency emitting devices. The primary cost of a 7460 approval is associated with any time delays required for approval. Although not required for military airfields, 7460 approval will be required for any joint use facility.

Site Preparation – Site preparation costs can be minimal if power and a suitable surface (for a trailer) or structure (for a permanent installation) is already available. Otherwise, surface preparation and a power hookup need to be provided for long-term use. Power requirements are modest with a 50 A standard service being more than adequate. In many cases, an extension cord to a 20 A residential-type receptacle will suffice. Some terrain grading near the radar site may also be desirable to reduce ground clutter. The installation typically takes care of any site preparation costs.

Wireless ISP/Point-to-Point Link – If an Integrated or Advanced radar system is deployed with remote access to users, network connectivity is required. In some cases, a hard-wired (CAT6, fiber, or coaxial cable) run may be available between the site and a suitable demarcation point at a nearby building. If not, commercial wireless links are usually available using either an off-site commercial Internet Service Provider (ISP) or by installing a point-to-point microwave link between the trailer and the demarcation point. The installation of a point-to-point link can cost from a few thousand dollars to more than \$10,000. This type of link avoids ongoing data charges between the radar and the demarcation point. The wireless ISP option may still incur monthly data charges.

Operation and Maintenance

Annual system operation and maintenance costs can typically run between about 10% and 20% of the radar system cost if contracted out, depending on the level of service acquired. This cost is directed to keeping the system operational over the life of the system, dealing with local training, commissioning, monitoring, technical support, and repairs & replacement.

Training – Training costs depend on the number and type of users of the system, and the nature of the system monitoring and technical support acquired by the facility. If the radar provider is contracted to maintain system performance, then training can be limited to user training which usually can be accomplished in under five days, depending on who the users' backgrounds (e.g., wildlife control, air operations). If the facility does not contract the radar provider for system monitoring and support, then additional training is needed to address maintenance issues as they arise. A local technician will need to be trained to maintain the system for the users. This is analogous to an IT administrator providing technical computer support to users. The local technician could require as much as 10 days of training to maintain the system, depending on system configuration, and may need refreshers from time to time, especially as system upgrades are made.

Commissioning – Commissioning of the radar system is a process that extends with radar provider support over several months to ensure the proper and intended operation of the system as the seasons, environment, the activity of birds and other targets change. This process ensures that users and system maintainers have demonstrated the ability to keep the system tuned within operating parameters. Radar performance can vary significantly as a result of changes in seasons (weather, snow, wind) and target environment (migration, local movements such as foraging, territorial and courtship activities, presence of insects, etc.)

System Monitoring/Technical Support – Once an avian radar is commissioned for operation to meet the needs of the local users, the system needs to be maintained within operating parameters so that it continues to provide users with meaningful and accurate situational awareness. Like any commissioned radar system that is relied upon by users, a variety of daily, weekly, monthly, and yearly operating parameters should be monitored, trended, and acted upon to keep the system operating at peak performance. Monitoring can extend the life of the radar system and pay for itself by highlighting potential problems so they are corrected before they shutdown the system.

Repairs/Replacement – An avian radar system has two types of components – the front-end analog radar sensor that includes the transceiver and antenna, and the digital backend that includes the digital processor and other digital components, which can be characterized as computer technology. The front-end radar sensor, being a marine radar, is robust and made for outdoor, 24/7 use. If the manufacturer's preventative maintenance and regular maintenance schedules are followed (which includes scheduled magnetron replacements at a cost of about \$1,200 to \$2,000, if applicable), the mean-time-between-failure (MTBF) is on the order of two-three years. A five-seven year system life is realistic. The backend computer-based components also have an expected life in excess of five years if preventative maintenance is implemented (e.g., change out of hard drives every couple of years due to 24/7 writing of radar data).

Network Data Charges – If a wireless cellular or ISP service is used to connect the radar trailer to the Internet for remote connectivity, charges from \$150/month to \$2,000/month can typically

be incurred, depending on what information is streamed over the network and the architecture employed.

Utilities – An estimate of a monthly electrical bill of \$100 would easily meet typical power needs.

System Lifetime

The radar system life time is estimated to be five to seven years, based on the expected lifetime of the radar sensor front-end and the digital, computer-based backend. The radar front-end transceiver will eventually fail, and antenna motors and related circuitry will wear out and require replacement. The computer-like backend also reaches an end of support life in a similar timeframe, where hardware replacement rather than repair reduces maintenance costs at the same time as increasing performance.

Future Technology

There are a number of technology improvements underway by system developers that will be ideal for consideration following end-of-life system replacement, and as upgrades if they are backwards compatible. These include new high-performance multi-beam antennas with electronic vertical scanning and Doppler capabilities in the radar sensor. The cost impact of these future improvements is expected to be relatively small in comparison to full life cycle costs.

7.2 COST DRIVERS

The cost drivers are largely a function of the capital equipment costs, deployment costs (e.g., site preparation and connectivity), and operational costs.

Capital costs for radar technology can be highly variable depending on configuration for site specific needs, which includes both the number of sensor units and the associated basic integration and fusion capacity defined for multiple sensor deployment. Unit costs for radars can be expected to range from \$250,000 to \$750,000 depending on configuration. Purchase, lease, and service options may be available depending on vendor. For purchase of the equipment, it is expected that capital costs would be based on standard procurement processes that would provide least cost for advertised specifications. Most of the future engineering, modifications, and upgrades to the equipment are expected to be capitalized by the manufacturer and recouped in the purchase, lease, or service cost for the technology.

Operation and maintenance costs for the technologies are largely controlled by the labor rates and the number of personnel required to field the equipment, analyze the data, and generate the documentation associated with the project.

7.3 COST ANALYSIS AND COMPARISON

As discussed in Section 7.1, the cost of acquiring, installing, and operating an avian radar system can vary greatly depending upon the facility's requirements. In this section we chose a "middle-ground" configuration for what we believe would be a typical installation.

Timeframe: We chose a five-year timeframe as a tradeoff between the probable system lifetime (5-7 years) and the cumulative technological advances during this period that would favor replacement rather than upgrades.

Radar System. We chose a single, integrated, trailer-mounted system: A single radar because most facilities would probably start with just one radar and most military bases can be monitored by a single radar; an integrated system because it provides remote access for visualizing and analyzing the target track data and because it can reduce the need (and cost) for onsite training and maintenance; and a trailer-mounted system because it provides greater flexible in locating the radar.

Installation. We assumed that a fairly substantial assessment would be required to locate a suitable site for the radar, but that there would be no licensing fees because it is a military facility. We further assumed that a concrete pad would need to be built for parking the trailer at the selected site, but that shore power was nearby and that network cabling would not be required because a wireless point-to-point link would be provided.

Operation and Maintenance. We chose the low end of the range of the estimated operations and maintenance charges because we paid the higher price for an integrated system with network access, which permits many of these procedures to be handled remotely by the vendor. **Table 7-4** summarizes the estimated cost of a system that would result from the specified configuration and assumptions.

Table 7-4. Estimated cost of a typical avian radar system amortized over a five-year lifespan.

Element	Configuration	Cost	Comment
Timeframe	5 years		Tradeoff system lifetime vs. technological advances
Radar System	Integrated	\$400K	Network-capable for remote access & support.
Installation	Site Assessment	\$25K	
	Licensing	\$0K	N/A: Military facility
	Site Preparation	\$5K	Concrete pad only
	Communications Link	\$3K	Wireless, off-site ISP
Operation & Maintenance	Training	\$200K	20% per year for five year
	Commissioning		
	Monitoring/Support		
	Repairs/Replacement		
	Network Data Charges	\$0K	Assumes wireless point-to-point link.
	Utilities	\$7.2K	\$100/mo for 5 years
TOTAL COST		\$640K	

As discussed in Section 2.5, none of the methods currently used to sample bird activity are strictly comparable to data collected by avian radar systems. The most commonly used methods for both BASH and natural resources management applications involve visual and auditory census. However, these methods cannot be used at night or with poor visibility, they are not well-suited to real-time monitoring, and using human observers to sample 24/7/365 would be both impractical and cost-prohibitive. In addition to sampling automatically and continuously in

real time, avian radars and can detect and track many more birds (Section 6.2.1.5). A single biologist using an avian radar system can survey an area more completely and document its data for a lower cost than multiple biologists that would be used if an avian radar system were unavailable (see Section 6.6.1.1). This latter approach is the one that is currently used as the standard protocol. Thus, a more productive approach will be to use both approaches because they are complementary: use avian radars for continuous routine surveillance sampling and visual observers to fill in the gaps where the radars are not effective (e.g., in forested areas, or where species identifications are required). Using the radars for routine sampling would also free up the wildlife biologists and BASH managers to concentrate on interpreting the radar data and investigating the patterns of activity those data yield.

In Section 6.6.1.1 we argued that an avian radar system costs much less (\$20/hour vs. \$100/hour) and can detect many more birds than a human observer expending the same level of effort. These arguments notwithstanding, the more likely scenario is to use the avian radar to augment rather than to replace field observations by the wildlife biologist. If we assume that the biologist would still spend the requisite 10 hours/week in the field observing birds, albeit differently because the radar is now performing continuous real-time surveillance of the bird populations, then the true cost of monitoring bird activity at a facility over a five-year period would be the aggregate cost of the avian radar system (\$640k, **Table 7-4**) and the portion of the biologist's time devoted field observations (\$260K, p. 258).

8 IMPLEMENTATION ISSUES

All of the avian radar systems evaluated during the IVAR project are commercial off-the-shelf (COTS) products. All use COTS hardware components, from the radar's RST to the CPU of the digital radar processor. They also use conventional, sometimes standard, and frequently open-source interfaces and software components, although the software implementations of the detection and tracking algorithms are proprietary. Moreover, there are no environmental regulations governing the use of avian radar technology. There are, however, several important issues that will need to be considered before implementing avian radar systems at a DoD facility. These issues are discussed below.

Site Selection. Apart from cost (see Section 6.8), the primary issue with regard to implementing avian radar technology at military airfields²⁹ in particular will be the site selection process. As described in Section 6.6.2.3, this process first requires the user to obtain approval to operate an RF device at the facility, followed by a determination of where the radar can be operated at a safe distance from personnel, fuels, and ordnance (i.e., HERP, HERF, and HERO). Moreover, the height of structures (e.g., a trailer with a roof-mounted RST and antenna) are restricted at airfields as a function of their distance from a runway (known as the Runway Protection Zone).

Once these restrictions on where the radar can be sited have been resolved, issues related to choosing a site for optimal performance of the radar must be considered. Chief among these will be coverage and clutter. Obviously, the radar must be located so that the radar beam samples the areas of interest for the intended applications. Topography, vegetation, buildings and other manmade structures may all prevent adequate coverage of some areas. These same factors can, even if they do not block the radar beam completely, increase the amount of "ground clutter" to such an extent that the radar processor's clutter suppression process also removes weak targets such as birds. Evaluating the clutter environment can be a particularly vexing process and typically requires the expertise of radar professionals.

Other factors that may need to be considered in the site selection process include whether it is feasible (and cost-effective) to construct a (semi-)permanent site for the radar, and to install utilities and network connectivity at an otherwise desirable location.

The selection of a site for the radar is usually based on an aggregate of factors, rather than any single factor: radiation hazard and height restrictions may limit potential sites to ones that are sub-optimal with regard to coverage or clutter. Moreover, it may be necessary to evaluate some of these factors sequentially. There is no value in devoting the time and expense to evaluate coverage and the clutter environment for a site that is likely too close to an explosive hazard or to a runway. Each of steps in the site selection process has built-in time delays and costs that need to be planned for in the overall procurement projects.

The Federal Aviation Administration has prepared detailed guidelines for for siting avian radars at civil airports (FAA 2010). Since the worldwide aviation community follows many of the equipment and procedural standards set by the FAA, it can be anticipated that this guidance for civil airports will be adopted and adapted by military airfields as well.

²⁹ Civil airports have similar requirements for siting radars. The CEAT project is addressing these requirements.

Network Connectivity. The US Department of Defense requires that Automated Information Systems, including hardware, software, and communications equipment, must first pass a stringent DoD Information Assurance Certification and Accreditation Process (DIACAP³⁰) before it can be connected to a DoD communications network. DIACAP certification expires after three years, and intervening hardware or software upgrades may require recertification of the entire system.

If avian radar technology is to be fully integrated into the operational environment at DoD facilities, such that a variety of users can access bird target information, the technology will have to be DIACAP-certified. Ideally this can be done as a “type” certification, which would permit any systems of that type to be connected to any DoD network³¹. However, given their differences in hardware and software, each vendor’s avian radar systems would still need to be certified separately.

The cost of obtaining DIACAP certification is typically borne by the vendor. For this reason, DIACAP certification was not considered as a cost element Section 6.8, but is considered as an operational issue in this section.

Given the DoD’s lead in the field of information security, it is highly likely that the same or similar information assurance standards will be adopted in the future by other federal, and perhaps private organizations, including civil airports.

None of the avian radars evaluated by the IVAR project have been DIACAP-certified; consequently, none was connected to the LAN or WAN networks at the military study locations. In some instances (e.g., NASWI) it was possible to obtain outside WAN connectivity using a wireless (e.g., cell phone card or WiFi) link. Depending on who and where the users are at a facility, and who requires access to the radar information, it is possible to construct a LAN using commercial services and point-to-point links, staying off of defense networks entirely

Other Technical Issues. A number of technical issues related to avian radars have been mentioned elsewhere in this report that should be considered along with other implementation issues. For example, array antennas provide very poor altitude resolution of targets, which could limit their utility for some applications. Dish antennas provide more accurate height information, but the uncertainty in the computed height increases as a function of range. Likewise, increased uncertainty in the height of the target increases the error in computing the targets “ground track” (spatial coordinate of the target’s position projected onto the ground) from the slant-range measured by the radar. However, now that there appears to be a growing and viable market for avian radar systems, vendors will no doubt step forward with new products that address these issues. ARTI, for example, has recently introduced a multi-beam avian radar antenna that purports to double the vertical beam width (from 4° to 8°) of a single-dish antenna, while at the same time increasing the accuracy of the height computations³². Solid-state radars have recently come on the market that reduce the mean time before maintenance is required, but they are more expensive than conventional radars based on magnetrons and have yet to be objectively evaluated for bird-tracking applications. One of the potential benefits of these solid-

³⁰ Prior to 2006, this certification process was known as the Department of Defense Information Technology Security Certification and Accreditation Process (DITSCAP).

³¹ The alternative is a “site” certification, which limits the connection of the system to a specific site (e.g., a specific military base).

³² <http://www.accipiterradar.com/Accipiter%27s3D-360Deg.pdf>

state radars is the use of coherent filtering within the radar sensor to reduce clutter. Similar technological advances can be anticipated in clutter removal algorithms, data analysis and visualization products, and a host of other components.

Using the Information from an Avian Radar System. Automated, real-time avian radar systems are so new that it is unclear at this stage what type(s) of information each potential class of end-user will want. It is, however, apparent that in the near-term the primary applications will be those of natural resources managers and BASH personnel who will use the information to better manage the bird populations at their facility – for a variety of environmental and air-safety applications. These users are likely to use these systems to increase their coverage of local and migratory bird populations – to “do more with less.” In most cases they will use this expanded coverage to elucidate spatial and temporal patterns and the underlying dynamics of those populations. In some cases their uses may include real-time data feeds, such as the “sense and alert” scenarios discussed in Section 6.3.1.5 and Section 6.3.1.4, but principally avian radars will allow the resource managers to respond to events the radar has detected in a more timely matter. How, and in what form, the data avian radars can provide will be conveyed to control tower personnel or air crews will be the subject of many investigations as these systems are brought online at military and civil airports alike.

Relationship Between the IVAR and CEAT Projects. As discussed throughout this report, the Center for Excellence in Airport Technology (CEAT) at the University of Illinois and the IVAR project were collaborative efforts. CEAT was sponsored by the Federal Aviation Administration (FAA) to evaluate the deployment of avian radar technology at civil airports, and focused its attention on the processes for the selecting, deploying, and using avian radar technologies for BASH applications within the operating environments at those facilities. IVAR was funded by DoD (ESTCP) to demonstrate the maturity of avian radar technology for both natural resources management and BASH applications at military facilities (including airfields), and focused more on validating that the technology could be performed as required by these two applications. The CEAT and IVAR efforts were initiated about the same time and shared resources, personnel, and data. They both wound up evaluating avian radar systems from Accipiter Radar Technologies, Inc., although they arrived at that selection through independent paths. In fact, it was through ARTI that the two projects became aware of one another. The two projects produced their statements of functional requirements and performance specifications for avian radars independently, based on the requirements of their different audiences³³. However, those specifications were often based on shared data, and the staffs of the two projects reviewed drafts of the other’s documents. Both projects independently reached the same conclusion regarding the state of avian radar technology and where it can be most effective in its current state – as a tool to support wildlife managers. Consequently, the IVAR staff fully anticipates that once Advisory Circular 150/5220-25 (FAA, 2010) has been fully adopted by the FAA, its guidelines will be widely utilized by civil and military airfields alike.

These similarities and collaborations notwithstanding, neither audience for avian radar technology, civil or military, is dependent upon the results of either project in their acquisition or application of this technology. Compliance with the Advisory Circular 150/5220-25, which was generated from the results of the CEAT project, is mandatory only if a civil airport is seeking

³³ Those audiences are often the same: For example, at “Joint-Use” facilities where the Air National Guard and a civil airport might share the same runways and control towers, and have similar safety management programs.

Airport Improvement Program (AIP) funds to help pay for the avian radar system. Both projects conducted similar demonstrations but for different audiences. Both produced evaluations and guidelines for applicability of this technology. The fact that they were able to work together so closely has increased the value of both DoD's and the FAA's investment in the evaluation of avian radar technology.

Technology Transfer. This report summarizes the demonstrations conducted by the IVAR project that establish the avian radar systems we evaluated are mature, they can operate under a wide range of realistic conditions at military facilities, and they can generate a variety of parametric data from avian targets and present those data as useful data products for both real-time and historical applications. In short, these products are ready for market.

The avian radar systems and components discussed in this report, or their commercial equivalents³⁴, are available for purchase as off-the-shelf products. Avian radar products by other vendors (see Section 6.7) are also available for purchase. All of these vendors have system configurations that are suitable for natural resources management and for BASH applications. All have experienced wildlife management and/or BASH personnel on staff who can assist the end-user with the selection, siting, commissioning, and operation and maintenance of their products, plus documentation and training courses for these products.

Avian radar technology is also developing rapidly as the requirements of the BASH and natural resources management markets become better defined. Better height-finding antennas, solid-state transceivers, and advanced situational awareness displays and alert notification software have come onto the market in the short time since the IVAR project completed its studies. Improvements in the technology and its application should continue as the markets continue to grow. However, as is often the case with maturing technologies, the issues surrounding avian radar systems today are less about the technology and more about the application of that technology.

The FAA Advisory Circular (AC) 150/5220-25 (FAA, 2010) provides a good roadmap and concept of operations (CONOPS) for selecting, deploying, and operating avian radar systems for BASH applications. It discusses the benefits and limitations of avian radar technology, and provides sound recommendations on the importance of developing a clear understanding of a facility's needs and requirements before deciding to acquire and use this technology. The Advisory Circular also provides functional and performance specifications for avian radar systems, similar to those presented in Appendix B of this report, plus additional system standards. Finally, the AC provides guidance on the deployment and operation and maintenance of avian radar systems at airports. Much of the information in the AC is equally applicable to civil and military applications.

In addition to the published guidance in the FAA Advisory Circular, the four military facilities that participated IVAR project (see Section 4) have personnel on staff who are experienced in the application of avian radar technology for both BASH and natural resources management applications. Contact information for these individuals is available from the author of this report upon request. BASH personnel at other military airfields that were not part of the IVAR project

³⁴ The eBirdRad systems that form the centerpiece of the avian radar systems evaluated by the IVAR project were developed for test and evaluation purposes. The CEAT project purchased the commercial equivalents from ARTI for its studies. It is these commercial products, or their even more modern equivalents, that military facilities would purchase in today's marketplace.

and that might be using an avian radar system by another vendor may be another source of information.

Increasingly, both civil and military airports are contracting with the United States Department of Agriculture, Wildlife Services (USDA/WS) for wildlife management at their facilities. The use of avian radar systems has been presented to many of the certified airport wildlife managers. Thus, while not all USDA/WS personnel have firsthand known of avian radars, they have been exposed to it and are aware of resources that are available on this topic.

As regards internal policy and funding mechanisms for avian radar systems within the military, the Air Force BASH program of record (POR) is administered by the Air Force Safety Office. The Air Force's BASH program is headquartered at Kirtland AFB in Albuquerque, New Mexico. The Navy (including the Marine Corps) has recently elevated BASH to a POR that will, when fully implemented, be administered by the Commander of Naval Installations Command (CNIC). The Navy/Marine Corps Safety Center is located in Norfolk, Virginia, and the BASH program is currently run out of NAS Whidbey Island, Washington.

9 REFERENCES

- Anderson, C., and S. Osmek. 2005. Raptor Strike Avoidance at Seattle-Tacoma International Airport: A Biological Approach. 2005 Bird Strike Committee-USA/Canada 7th Annual Meeting, Vancouver, BC. (<http://digitalcommons.unl.edu/birdstrike2005/1/>)
- Blackman, S.S. 2004. Multiple Hypothesis Tracking for Multiple Target Tracking. *IEEE A&E Systems Magazine* 19(1). January, 2004.
- Brand, M., Key, G.; Herricks, E.; King, R.; Nohara, J. T.; Gauthreaux, S., Jr.; Begier, M.; Bowser, C.; Beason, R.; Swift, J.; Klope, M.; Griese, H.; Dotur, C.. 2011. Functional Requirements and Performance Specifications for Avian Radar Systems Integration and Validation of Avian Radars (IVAR). Space and Warfare Systems Center – Pacific [Document number to be added]
- Burger, A.E. 1997. Behavior and numbers of Marbled Murrelets measured with radar. *Journal of Field Ornithology* 68(2):208-223.
- Dolbeer, R.A. 2006. Height distribution of birds recorded by collisions with civil aircraft. *Journal of Wildlife Management* 70 (5):1345-1350.
- FAA. 2009. Code of Federal Regulations, Part 139 (Certification of Airports), Subpart D (Operations), Section 139.337 (Wildlife Hazard Management). <http://tinyurl.com/FAR139-337>
- FAA. 2010. “Airport Avian Radar Systems”, DRAFT Advisory Circular 150/5220-25. [Final version due December 2010.] http://www.faa.gov/documentLibrary/media/Advisory_Circular/draft_150_5220_25.pdf
- Gauthreaux, S.A., Jr. 1999. Legacy Project Cooperative Agreement DACA87-97-0002. Interim Technical and Progress Report for the Period of October 1998--October 1999. Legacy Resource Management Program, Department of Defense.
- Gauthreaux, S.A., Jr., and J.W. Livingston. 2006. “Monitoring bird migration with a fixed-beam radar and a thermal-imaging camera.” *Journal of Field Ornithology* 77(3):319–328.
- Harmata, A.R., K. M. Podruzny, J.R. Zelenak, and M.L. Morrison. 1999. Using Marine Surveillance Radar to Study Bird Movements and Impact Assessment. *Wildlife Society Bulletin* 27(1):44-52.
- Herricks, E.E., and G. Key. 2007. Avian Radar Systems. *International Airport Review* 6:56-59.
- Klope, M.E., R.C. Beason, T.J. Nohara, and M.J. Begier. 2009. Role of near-miss bird strikes in assessing hazards. *Human–Wildlife Conflicts* 3(2):208–215.
- Lack, D., and G. C. Varley. 1945. Detection of birds by radar. *Nature* 156:446.
- Nohara, T.J., P. Weber, A. Premji, C. Krasnor, S. Gauthreaux, M. Brand, and G. Key. 2005. Affordable Avian Radar Surveillance Systems for Natural Resource Management and BASH Applications. Radar ‘05 Conference, IEEE International [Online copy]

- Nohara, T.J., P. Weber, A. Ukrainec, A. Premji, and G. Jones. 2007. An overview of avian radar developments: Past, present and future. Proceedings Bird Strike Committee USA/Canada, Kingston, Ontario, Canada.
- Nohara, T.J., P. Weber, G. Jones, A. Ukrainec, and A. Premji. 2008. Affordable high-performance radar networks for homeland security applications. Radar '08 Conference, IEEE International.
- Osmek, S., P. Viehoever, E. Herricks, and T. Nohara.. 2009. Avian radar for evaluating wildlife hazard mitigation measures employed at Seattle-Tacoma airport stormwater ponds. Abstract in 2009 Bird Strike North America Conference Program. p. 32
- Ruth, J.M. (ed.). 2007 Applying radar technology to migratory bird conservation and management: strengthening and expanding a collaborative: Fort Collins, Colo., U.S. Geological Survey, Biological Resources Discipline, Open-File Report 2007-1361, 84 p.
- Stein, B.A., C. Scott, and N. Benton. 2008. Federal lands and endangered species: The role of military and other federal lands in sustaining biodiversity. *BioScience* 58(4):339-347.
- USGS. nd. Modified Marine Radar. US Geological Survey, Fort Collins, Colorado.
<http://www.fort.usgs.gov/Radar/Bib_Marine.asp>

APPENDIX A. POINTS OF CONTACT

POINT OF CONTACT Name	ORGANIZATION Name Address	Phone Fax E-mail	Role in Project
Marissa Brand	SSC Pacific Postal Mail: 52570 Silvergate Ave, Building 111, Floor 1, Room 214, San Diego, CA 92152	619.553.5334 (w) 619.553.6305 (f) marissa.brand@navy.mil	Project Manager
Gerry Key	CSC Postal Mail: 2806 NE 12 th Avenue Portland, OR 97212	503.922.2566 (w) 503.922.2566 (f) gkey@accipiterradar.com	Technical Lead
Robert Beason	Accipiter Radar Technologies Corp. Postal Mail: P.O. Box 737 Sandusky, OH 44871 Shipping: 2912 Huron Avery Rd. Huron, OH 44839	905.892.2249, Ext. 223 (w) 419.433.2738 (h) bbeason@accipiterradar.com	Radar Ornithologist
Mike Begier	USDA APHIS Wildlife Services Postal Mail: 1400 Independence Ave., SW South Agriculture Bldg., Room 1621 Washington, D.C. 20250 Shipping: [Same – preferred]	202.720.4383 (w) 202.690.0053 (f) mike.begier@aphis.usda.gov	Wildlife Biologist/BASH Manager
Chris Bowser	USDA/APHIS/ Wildlife Services Postal Mail: EAD (USDA WS) Attn: Chris Bowser Box 8006, BLDG 4223 Access Road MCAS Cherry Point, NC 28533-0006	252.466.9237 (w) 252.466.9105 (f) christopher.o.bowser@aphis.usda.gov	Wildlife Biologist/BASH Manager
Robert Clark	CSC Postal Mail: 4045 Hancock St. San Diego, CA 92110	619.225.2633 619.226.0462 rclark8@csc.com	Prime Contract Manager

POINT OF CONTACT Name	ORGANIZATION Name Address	Phone Fax E-mail	Role in Project
Andy Del Collo	Chief of Naval Operations (N45) Postal Mail: 200 Navy Pentagon (NC-1 Suite 2000) Washington, DC 20350-2000 Shipping: 2511 Jefferson Davis Highway Suite 2000 Arlington, VA 22202	703.602.2550 (w) andy.delcollo@navy.mil	Sponsor
Sid Gauthreaux, Jr.	Clemson University Postal Mail: P O Box 9 Edisto Island, SC 29438-0009 Shipping: 8360 Peters Point Rd Edisto Island, SC 29438	843.869.2383 (w) 843.869.2383 (f) gocajuns@bellsouth.net	Radar Ornithologist
Herman Griese	United States Air Force Postal Mail: 3 CES/CEANC 6326 Arctic Warrior Drive Elmendorf AFB, Anchorage AK 99506-3240	907.552.0200 (w) 907.552.1533 (f) herman.griese@elmendorf.af.mil	Wildlife Biologist/BASH Manager
Joe Hautzenroder	NAVFAC HQ Postal Mail: 1322 Patterson Avenue SE Building 33 Floor 2 Room 33-2014 Washington Navy Yard Washington, DC 20374	202.685-9331 (w) joseph.hautzenroder@navy.mil	Sponsor
Ed Herricks	University of Illinois Postal Mail: 3230B NCEL, MC-250 205 N. Mathews Urbana, IL 61801	217.333.0997 (w) 217.333.6968 (f) herricke@illinois.edu	Collaborator

POINT OF CONTACT Name	ORGANIZATION Name Address	Phone Fax E-mail	Role in Project
Ryan King	Federal Aviation Administration Postal Mail: AJP-6311 Airport Safety R&D Sub-Team Building 296 FAA Wm. J. Hughes Technical Center Atlantic City Int'l Airport, NJ 08405	609.485.8816 (w) 609.485.4845 (f) ryan.king@faa.gov	Collaborator
Matt Klope	Navy BASH Program Postal Mail: 1115 W. Lexington Street, Building 103 Oak Harbor, WA 98278	360.257.1468 (w) Matt.klope@navy.mil	Wildlife Biologist/BASH Program Manager
Steve Osmek	Seattle-Tacoma International Airport Postal Mail: Port of Seattle P.O. Box 68727 Seattle, WA 98168 Shipping: Main Terminal Building Center Service Tunnel 17801 Pacific Highway So. Seattle, WA 98158	206.431.4453 (w) 206.433.4645 (f) osmek.s@portseattle.org	Senior Wildlife Biologist/Manager
Laura Muhs	NAVFAC HQ Postal Mail: 1322 Patterson Avenue SE Building 33 Floor 2 Room 33-2021 Washington Navy Yard Washington, DC 20374	202.685.9128 (w) laura.muhs@navy.mil	Early Adopter
Tim Nohara	Accipiter Radar Technologies Inc Postal Mail: P O Box 939 Fonthill, Ontario LOS 1E0 Canada Shipping: 576 Hwy 20 West Fenwick, Ontario LOS 1C0 Canada	905.228.6888 (w) 905.892.2249 (f) tnohara@accipiterradar.com	Radar Systems Design

POINT OF CONTACT Name	ORGANIZATION Name Address	Phone Fax E-mail	Role in Project
James Swift	NAVFAC Washington, U.S. Navy Postal Mail: 22541 Johnson Road Building 1410 Naval Air Station Patuxent River, MD 20670-1700	301.757.0006 (w) 301.757.1889 (f) james.swift@navy.mil	Wildlife Biologist/BASH Manager

APPENDIX B. ANALYTICAL METHODS SUPPORTING THE EXPERIMENTAL DESIGN

METHOD #1: VALIDATION BY SIMULATION

We used the following Validation by Simulation method to test whether the Multiple Hypothesis Testing (MHT) and Interacting Multiple Model (IMM) tracking algorithms (Blackman 2004) used in the Digital Radar Processor (DRP) of the eBirdRad avian radars evaluated by the IVAR project could accurately track synthetic targets; that is, targets with known dynamic behaviors generated using software.

We used an in-house software simulation tool to generate sequences of detections that were consistent with avian target dynamics. The simulation tool outputs a plot file in the same format as does the DRP when operating in real time. The plot file generated by the simulation tool was then replayed through a DRP for off-line re-processing (i.e., re-tracking), and the resultant tracks compared with the known dynamics of the targets generated by the software.

The simulated targets we generated for this analysis had the following characteristics:

- A total of twenty (20) simulated targets that were “flying” simultaneously were generated.
- The speeds of these targets were set to approximately 55 km/hr – emulating typical bird speeds.
- We organized the targets into four groups, assigning 4 to 6 targets to each group.
- For certain times during the simulation, we assigned the simulated targets the following motion dynamics that would be consistent with single birds and flocking birds.
 - a. The targets were made to be far enough apart to simulate a separated target-tracking scenario.
 - b. The targets were crossing to simulate a crossing tracking-tracking scenario.
 - c. Targets were converging to simulate a converging target-tracking scenario.
 - d. Targets were made to maneuver to simulate a maneuvering target-tracking scenario.
 - e. Targets were made to diverge from one another to simulate a diverging target-tracking scenario.

We replayed the plots file generated by the simulation tool through the DRP and the resultant tracks were displayed on the DRP monitor to determine if their dynamics matched those specified in the software. We used the DRP’s built-in camera tool to take periodic snapshots of the display to document the targets’ dynamics.

Figure B-1 and **Figure B-2** are examples of the types of target-track images generated by processing the plots files generated by the simulation tool.

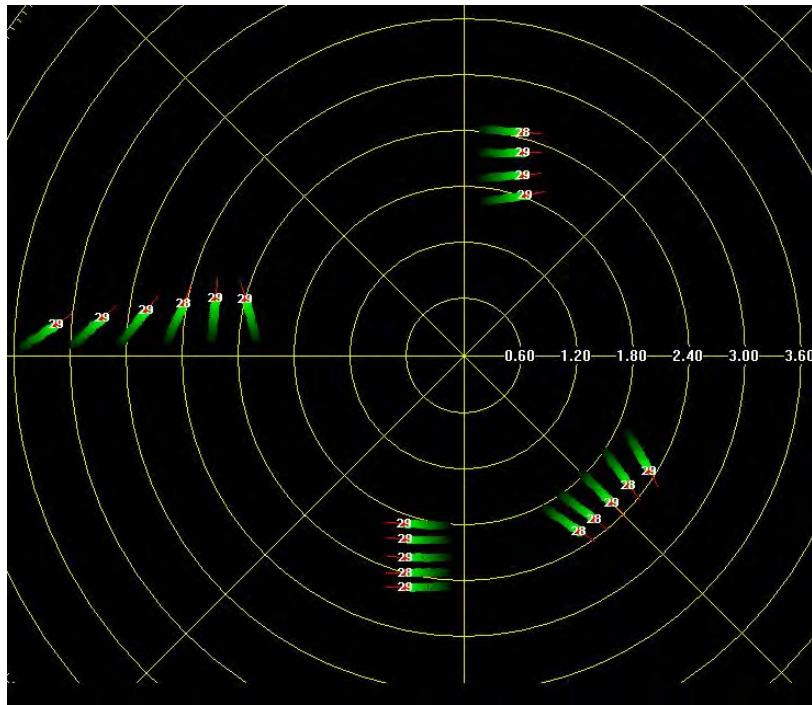

Figure B-1. Display of simulated targets near the beginning of the simulation. Detections (represented by green circles) as well as tracks (represented by red squares) are indicated. The numbers represent the target's speed in knots (1 knot = ~1.8 km/hr).

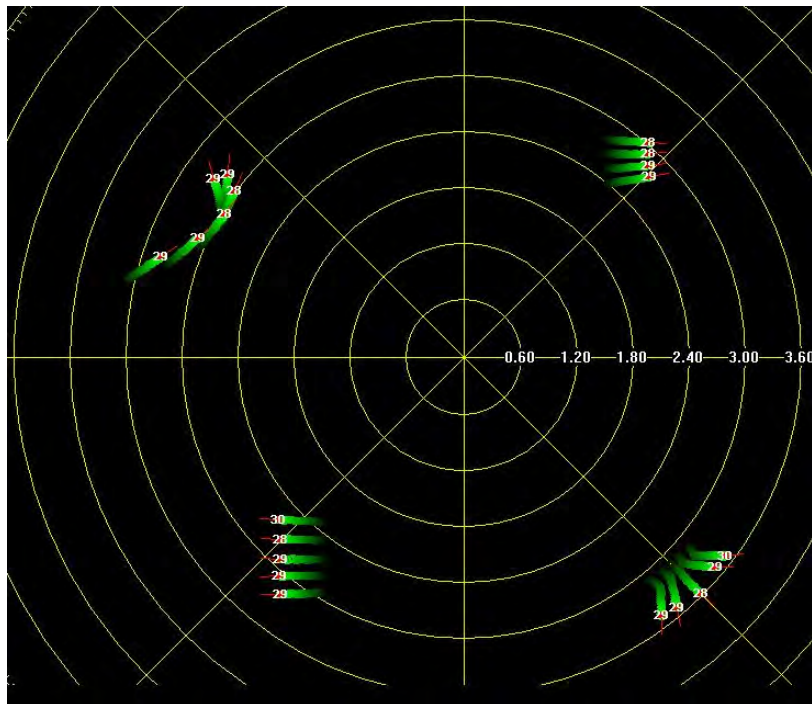

Figure B-2. Display of simulated targets several minutes into the simulation, using the same color scheme as described in Figure B-1.

METHOD #2: VALIDATION BY IMAGE COMPARISON

Since most long-time radar ornithologists are familiar with the standard Plan Position Indicator (PPI) display of analog radar systems, a basic test of any digital avian radar system is to determine whether it can reproduce that PPI display digitally. We used the following method to demonstrate that capability of the Accipiter® Digital Radar Processor (DRP) used by the eBirdRad avian radar system evaluated by the IVAR project. The purpose of this method is to provide users who are familiar with analog avian radar systems with the confidence that the digital system is at least “seeing” the same radar return data as the analog system.

The electronics supplied with the Furuno 2155BB marine radar (i.e., the processor used by BirdRad) include a “True Trail” mode. In this mode, radar returns from the current scan are displayed in yellow, and the returns from up to 15 prior scans are displayed in increasingly darker shades of blue. The current returns (yellow) overwrite, or mask, the blue of prior returns. Since stationary objects such as the ground, buildings, etc. do not move from scan-to-scan, their current position (yellow) masks all their prior (blue) positions. Because the position of moving targets differs from scan-to-scan – the degree of difference being a function of the target’s speed – their current position (yellow) is offset from those of their prior positions (blue). The result is that a moving target appears as a yellow “head” representing the target’s current position, followed by a “tail” of one or more prior positions displayed in blue. Such a depiction of a target generated by the Furuno processor can be seen in **Figure B-3**, where the moving target is at a range of approximately 3.7 km (2 nmi; fourth range ring) and 320 degrees of azimuth from the radar at the center of the display.

The eBirdRad Accipiter® DRP includes a display mode that is a digital rendering of the True Trails mode: It employs the same convention of yellow for echoes from the current scan of the radar, increasingly darker shades of blue for echoes from prior scans, with yellow overwriting blue. **Figure B-4** is an example of the DRP’s emulation of the True Trails mode, and was generated by digitizing the same raw analog radar signal the Furuno 2155BB used to generate the image depicted in Figure B-3.

To compare the analog and digital renderings of the same scene, we used a Y-cable to simultaneously feed the same raw analog signal from a Furuno 2155BB X-band marine radar outfitted with a 4° dish antenna to the input of both the analog processor of a BirdRad system and the input to the digital processor of an eBirdRad system. The Furuno radar used for this comparison was being operated at NAS Patuxent River on 17 April 2007, at approximately 23:48 UTC (19:48 EDT).

Figure B-3 and Figure B-4 are examples of numerous pairs of snapshots that were taken of the BirdRad and eBirdRad displays, respectively. These snapshots were captured simultaneously by activating the Foresight® video capture board installed in the BirdRad processor and the camera feature of the Accipiter® DRP used in the eBirdRad system. The pairs of images taken in this manner were then compared visually to determine if the digital simulation was an accurate depiction of the analog representation of the same scene.

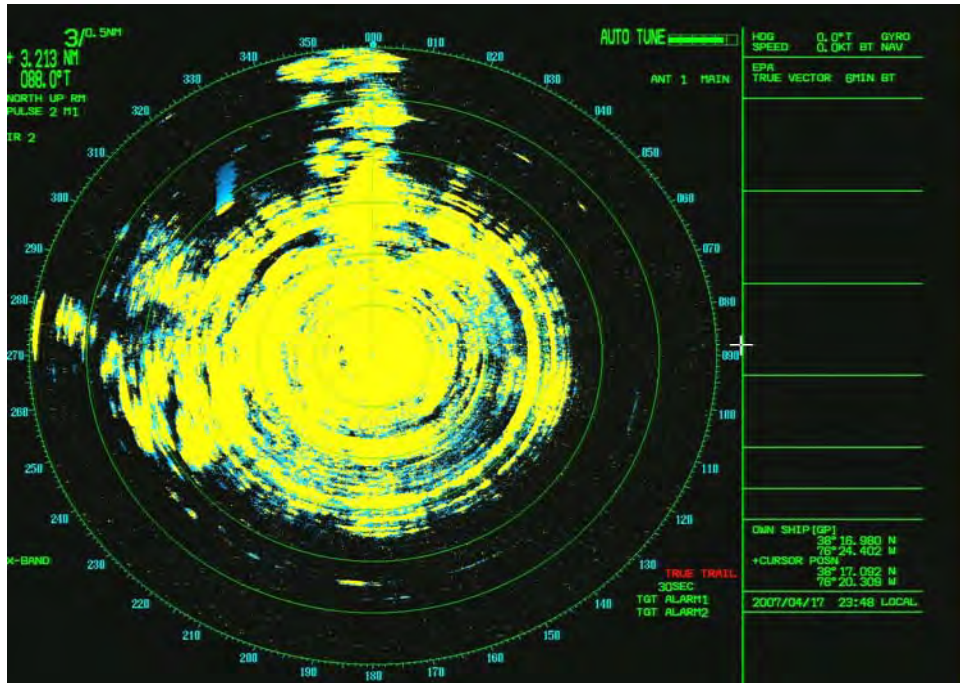

Figure B-3. Example of Furuno 2155BB True Trails mode display.

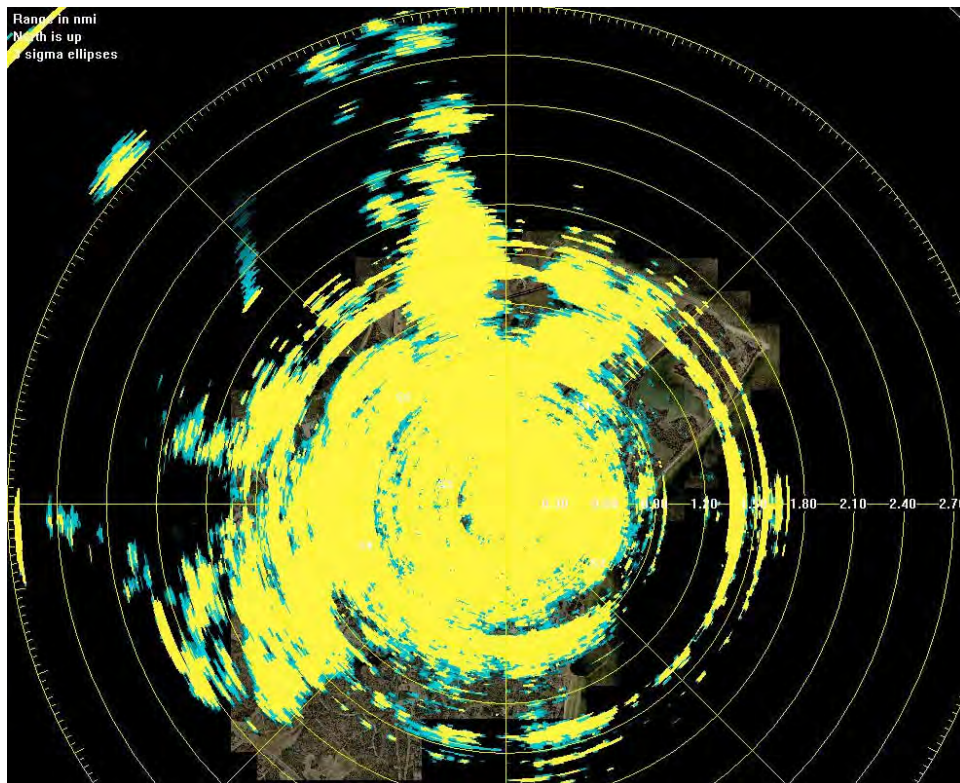

Figure B-4. Example of the digital rendering by the Accipiter® DRP of the same scene as in Figure B-3.

The pattern of yellows and blues in Figure B-3 and Figure B-4 are nearly identical, indicating the digital processor is faithfully rendering the same scene as the analog processor. However, that pattern is rotated counterclockwise (west) in digital rendering shown in **Figure B-4** when compared to the pattern in the analog display in **Figure B-3**. This is because both the analog and digital displays assume the radar is pointing toward geographic north, while the radar at NAS Patuxent River was pointing approximately 10° west of north at the time these data were gathered. This deviation cannot be corrected in the BirdRad system because it has no mechanism to rotate the image. In eBirdRad, on the other hand, the image can be rotated so that returns from strong reflectors are aligned properly with their position on the underlying geo-referenced map. Making this alignment in turn rotates the display to geographic north.

METHOD #3: VISUAL CONFIRMATION OF BIRD TARGETS.

This section outlines the procedures the IVAR team developed for making dependent visual observations (“ground-truthing”) to confirm that targets being automatically tracked by digital avian radar are birds.

These methods are termed “dependent” observations because the radar operator and the visual observers are not sampling the bird populations independently. In the “RT-Calls” scenario, the radar operator selects the targets the radar is tracking and broadcasts a request for a team to visually confirm the targets are birds. Likewise, in the “VT-Calls” scenario, one of the visual teams selects a bird they believe to be in the radar beam and broadcasts a request for confirmation to the radar team.

Materials

Radar Team (RT).

In addition to the radar sensor transceiver (RST) and antenna³⁵, the Accipiter® Digital Radar Processor, and the trailer, and the trailer-mounted GPS, the Radar Team (RT) used:

- Metal clipboard box equipped with
 - ✓ Digital wristwatch synchronized to Accipiter® master clock.
 - ✓ Hardcopy radar field data form (RT_Datasheet worksheet in MCASCP_Data_Sheets_070404.xls)
 - ✓ Pencils
 - ✓ Stapler
 - ✓ Digital audio recorder (similar to Sony ICD-P520)
- Base two-way radio

Visual Team (VT).

The personnel manning the Visual Team (VT) observations sites used:

- Garmin Etrex Vista handheld GPS
- Metal clipboard box equipped with
 - ✓ Suunto Tandem compass/inclinometer
 - ✓ Digital wristwatch synchronized to Accipiter® master clock.
 - ✓ Hardcopy visual field data form (VT_Datasheet worksheet in MCASCP_Data_Sheets_070404.xls)
 - ✓ Pencils
 - ✓ Stapler
 - ✓ Digital audio recorder (similar to Sony ICD-P520)
- Binoculars (personal)
- Base two-way radio

The sections below outline the procedures for selecting and setting up sites within the study locations for the Radar Team (RT) and Visual Teams (VT), respectively.

³⁵ Both a Furuno Model 2155BB X-Band marine radar with a 2-foot diameter parabolic dish antenna and a Furuno Model 8252 X-Band marine radar with 6-foot array antenna, both using the same Accipiter® Digital Radar Processor, have been used with these visual confirmation methods.

Radar Team (RT)

Site Selection

Since each of the demonstration locations selected by the IVAR project had an operational eBirdRad or AR-1/AR-2 unit, the siting of the radar was pre-determined. The criteria that were used to site the radars located at airfields included:

- A set-back distance from an active runway based on the height of the structure (i.e., trailer, radar, and antenna) – the Runway Protection Zone.
- Coverage of the entire facility, in particular the runways, by the radar beam.
- Coverage beyond the facility, over significant angular regions, in order to accumulate track histories of targets => 5 km from the radar (see Performance Criterion PA5.1 in Section 6.1.1.5).
- Proximity to electrical power and access roads.
- A safe distance from aircraft operations and other “hot” areas, as well as from ordnance and fuel storage areas (HERO & HERF) and from manned facilities (HERP).
- Low clutter environments.

Site Set-Up

Since the radar units at these locations had already been sited and were being operated continuously before and after the validation studies, no special set-up for the radar site was required.

Once the VT sites have been set up and the latitude and longitude coordinates of each site are known, the RT Operator can enter those coordinates into the DRP to create a placemark indicator of the VT sites on the DRP display. These placemarks will be used by the Operator in selecting targets that are near a VT site when requesting confirmation of the target by the VT.

Visual Team (VT)

Site Selection

The following factors should be considered in selecting sites from which the visual observers (i.e., VTs) will attempt to confirm the called targets that are being tracked by the radar.

- Project Objectives. Overall project objectives (see Section 1.2) require VT sites to be established throughout the facility, at various distances from the RT site, consistent with the restrictions listed in the bullets below. In particular, one or more VT sites at each study location should be positioned at least 2 km (1.2 miles) from the radar (see Performance Criterion PA4.1 in Section 6.1.1.4).

- Bird Activity. The overall goal when positioning VTs should be to place them in areas where they can observe (and potentially confirm) the bird activity the radar is being used to sample. Ideally, the radar should sample birds anywhere on the facility; as a practical matter, most of the factors listed below place some constraint on what the radar can detect, what the VTs can see, or both. Within these constraints, the best source for information about where to position the VTs is the onsite natural resource managers and, if available, historical data on areas of significant and representative bird activity: Significant because the goal is to confirm as many targets as possible; representative because the confirmations should include as many different species found at that facility as possible.
- Lack of Obstructions. Avoid areas where trees, buildings, or other obstructions that lie between the VT site and the radar and might block the radar beam's coverage of the site.
- Avoid Magnetic Interference. Avoid areas with large metal structures made of iron or steel (e.g., storm drain grates, metal fences) and electronics (e.g., communications equipment, electrical junction boxes) that could interfere with the magnetic compass used to record the bearing of targets from the VT site.
- Field of View. The observers need an unobstructed field-of-view from the VT site to the surrounding areas that are covered by the radar beam.
- Visual Overlap with Other VT Sites. Where possible, choose sites that are close enough to other VT sites so the different observers' field of view overlap, making it possible for more than one Visual Team to confirm the same target.
- Distance vs. Height. The elevation angle of the radar antenna is typically set between 5° and 10° above horizontal. For an antenna angle of 7°, the top of a 4° radar beam would be approximately 235 meters (775 feet) AGL at a VT site 1500 meters (approximately 1 mile) from the radar. Thus, the desire to have VT sites various distances from the radar to assess the detection and observation of targets as a function of distance has to be weighed against the increased difficulty for visual observers to see targets that are 200-300 meters overhead.
- Distance from Runways/Safety. Any demonstration facility that is an active airfield may have aircraft taking off and landing 24/7. The VT sites need to be far enough from operational runways, landing pads, high powered turn up areas, so that the observers will be protected from excessive noise, jet blast, exhaust fumes, etc.
- Vehicular Access. The VT sites should be close enough to an access road that the team does not have to go off-roading to get there.
- Further Demonstrations. While the primary objective of this demonstration is to gather data to demonstrate automatic tracking of birds, some of the follow-on demonstrations may have similar staffing, logistical, and sampling requirements. To avoid the cost of having to reassemble observation teams at these sites in the future, consider "piggybacking" these other studies, and their site selection criteria, into the current plan.

In addition to selecting the VT sites in advance, a known landmark will be needed as a standard for checking the teams' proficiency with and calibration of their compass/inclinometers. A single landmark that can be seen from all VT sites is best (e.g., the control tower at an airfield), although different landmarks for different VT sites can be used if necessary. The latitude and longitude coordinates and height of each landmark should be measured or obtained from existing sources. As part of the start-procedures at the beginning of each session, the Visual Observer

will measure the magnetic bearing to and the angle of inclination to the top of the landmark assigned to that VT site. These measured values will be used later to compute the location and height of the landmark from the VT site, and these computed values will then be compared to the actual values to check that the compass/inclinometers were being used correctly.

Site Set-Up

Onsite personnel at each facility pre-select the general position of the sites from which the VTs will make their observations. On the morning of the first day, the RT & VT teams tour all of the sites to familiarize themselves with each site's:

- Location, topography, and proximity to manmade structures;
- Proximity to trees, bodies of water and other common bird habitats;
- Position relative to the radar site; and
- Position relative to the estimated height of the radar beam over and near that position.

Within the general locale of a site, the team members agree upon a specific position for VT site. They then mark the center point of the site with a flag (**Figure B-5**) and use a GPS to record the longitude, latitude, and elevation coordinates of that site (**Figure B-6**). Next they use a compass to position a flag at each of the four cardinal compass points around the site, approximately 10 meters from the center flag (**Figure B-7**). These compass point flags aid the VT in orienting to the position of a target called out in an RFC.



Figure B-5. Placing flag marking center of VT site at MCAS Cherry Point.



Figure B-6. Using a GPS to record spatial coordinates of VT-2A site at MCAS Cherry Point.



Figure B-7. Using compass to locate flags at cardinal compass points around VT Site at MCAS Cherry Point.

Scheduling the Sessions

Depending on the study objectives and the number of VT sites required to cover the study area, the project leader must schedule a series of two-hour sessions to include a morning session that begins a half-hour before local sunrise, a midday session that spans local noon, and an evening session that begins a half-hour before local sunset. Given the associated staffing, logistical, and data processing requirements of a session, no more than two, rarely three, sessions per day should be planned. Within these bounds, the project leader must determine the total number of sessions (and thus, at two/day, the duration of the study), the distribution of sessions to ensure there are an equal number of morning, midday, and evening sessions, and the times those sessions should begin and end to catch sunrise, noon, and sunset. **Figure B-8** is an example of the schedule prepared for a 3-day, 6-session study conducted by the IVAR team at NAS Patuxent River in April 2007.

Tuesday				Wednesday				Thursday				
Mid-Day S1		Evening S2		Morning S3		Evening S4		Morning S5		Mid-Day S6		Wrap-up
Jim	RD	Jim	RD	Mike	RD	Mike	RD	Jim	RD	Mike	RD	
Peter	RD	Peter	RD	Bob	RD	Bob	RD	Mike	1	Bob	RD	
Sid G.	1	Sid G.	1	Kyle	1	Alexis	2R	Bob	RD	Jackie	1	
Marissa	1R	Marissa	2R	Alexis	1R	Jackie	4	Beth	1R	Alexis	1R	
Carrole	2	Carrole	1R	Jackie	2	Beth	5R	Kyle	2	Sid G.	2	
Beth	2R	Beth	3R	Beth	2R	Melanie	4R	Alexis	2R	Beth	2R	
Chris E.	3	Chris E.	2	Bob	3	Kyle	5	Patty	5	Jim	3	
Alexis	4R	Kyle	3	Kevin	3R	Jim	1	Marissa	5R	Melanie	3R	
Jackie	4	Alexis	5R	Jim	RD	Marissa	1R	Jackie	3	Kyle	4	
Bob	RD	Jackie	5	Marissa	5R	Sid G.	2	Kevin	3R	Marissa	4R	
Kevin	3R	Bob	4	Chris E.	5	Carrole	3			Carrole	5	
Laura	5	Sid G.	TH			Joe	RD			Kevin	5R	
Kimberly	5R	Carrole	TH			Kevin	3R					
						Sid G.	TH					
						Carrole	TH					

Morning Session: 6:30 a.m. meet - Start 7:00 a.m. - Finish 9:00 a.m.
 Mid-Day: 11:00 a.m. this may change slightly depending on bird movements
 Evening: 4:45 p.m. meet - Start at 5:30 p.m. - Sunset (7:27 p.m.)
 Thermal Session starts at 11:00 p.m.

Figure B-8. Sampling typical sampling schedule from NAS Patuxent River, Spring 2007. S1, S2, etc. = Session Number; RD=Radar; TH = Thermal Imager; 1, 2, etc. = Observer at that VT site; 1R, 2R, etc. = Recorder at that VT site.

Assigning the Teams

The project leader for the study location recruits the personnel who will make up the visual and radar teams and assigns them in advance to one of four roles for each session (e.g., see Figure B-8):

- Radar Operator – operates the radar; selects the targets on the radar screen and calls the RFCs for RT-Calls confirmations, or confirms targets on VT-Calls confirmation.
- Radar Recorder – records information about RFCs as they relate to the RT site

- Visual Observer – observes birds in the radar beam at a VT site; calls the RFCs for VT-Calls confirmations, or confirms targets for RT-Calls confirmations
- Visual Recorder - records information about RFCs as they relate to a VT site

A fifth role, Radio Operator, is usually assumed by one member of each team. Some Operators and Observers may be too busy identifying targets and gathering information, and will ask their team's Recorder handle the radio communications. Others prefer to make the radio calls themselves, reasoning that relaying the information to the Recorder, who then has to broadcast it to the other teams on the radio, slows down the process and is more prone to errors.

If the members of the radar team have not participated in this type of study before, it may be necessary to add a Radar Operator to the RT for the first 2-3 sessions. Once the flow of observing targets and handling the RFCs becomes familiar, most RTs find the Operator or the Recorder can handle the radio calls.

The Radar Operator is the only team member who requires prior training; specifically, to operate the eBirdRad unit, and in particular the Accipiter® DRP. All other RT and VT team members can receive on-the-job training. It is, however, desirable (though not essential) that the Visual Observers be “birders” – personnel who are experienced at making field identifications of birds. The primary function of the Visual Observer is to observe objects he or she thinks are in the radar beam and make the simple decision whether the called target is or is not a bird. Birders generally make better visual observers because they are experienced and making these sorts of observations and are often more skilled at quickly locating birds under varying conditions of weather, light, contrast, etc. Moreover, once they have located a target, birders are more likely to identify the bird to species, which in turn adds a wealth of secondary information about the size, shape, speed, flight behavior, etc. of the confirmed target. Birders who are familiar with the local avifauna is particularly beneficial in this regard.

If possible, use the same observer teams at the same VT sites. This will increase their familiarity with the site, its topography, the flight patterns of birds in that area, and the relative location of the radar beam above the site.

Deploying the Teams

As noted in the section on setting up the schedule, the teams need to assemble and be ready to deploy at least 30 minutes before the session begins. Before deploying to their VT sites, the teams confirm that their digital watches are synchronized. Once on-site, the VT Observer positions him/herself near the flag marking the center of the VT site and sights in the known landmark to check the compass/inclinometer (see page 304). Meanwhile the VT Recorder fills in the header information on the field data forms, starts the digital audio recorder (DAR)³⁶ and records on the field data form the bearing and inclination of the landmark. The RT Operator uses this time to confirm the radar and processor are operating normally, while the RT Recorder fills in the header of the RT field data form and starts the DAR. The RT then conducts a radio check to confirm all VTs are in position and their radios are working correctly.

³⁶ In prior studies, both the Radar and the Visual Teams used digital audio recorders to record the communications between the members of the team during a session. These recordings were made in case questions arose about an observation. These recordings were saved and archived but have not, to date, been used.

RT-Calls vs. VT-Calls

At the discretion of the project leader, a pre-session may be conducted in which the VTs broadcast requests to confirm birds they have observed visually and the RT attempts confirms that target as a track on the radar screen. The objectives of this pre-session are twofold:

- To familiarize the VTs with the location and extent of the radar beam near their site by having them get immediate feedback on targets they think are in the beam but may or may not be according to the radar.
- To gather statistics on the confirmation rate when the VTs call the targets (“VT-Calls”) and the radar confirms versus the confirmation rate of the more direct method of the RT calling the targets (“RT-Calls”) and the VTs confirming.

VT-Calls require separate RFC broadcast protocols to avoid collisions caused when two or more VTs request confirmations by the RT at the same time. They also require slight modifications to the field data forms so that, for example, the RT records the Track ID of the target (which is known to the RT operator but not the VT) on the target confirmation data form.

Starting the Session

When all the preparations are complete, the RT broadcast a message that the session has started, including the session number and start time according to the radar:

RT: “Session 5 has begun at zero-five, two-six, three-one.”

Both VT and RT Recorders note the start time on their field data forms, as well as any difference between the broadcast (radar) start time and the time on their digital watches.

Calling and Confirming Targets

Figure B-9 outlines the procedures used to make dependent observations to confirm whether or not a target being tracked by the radar is a bird.

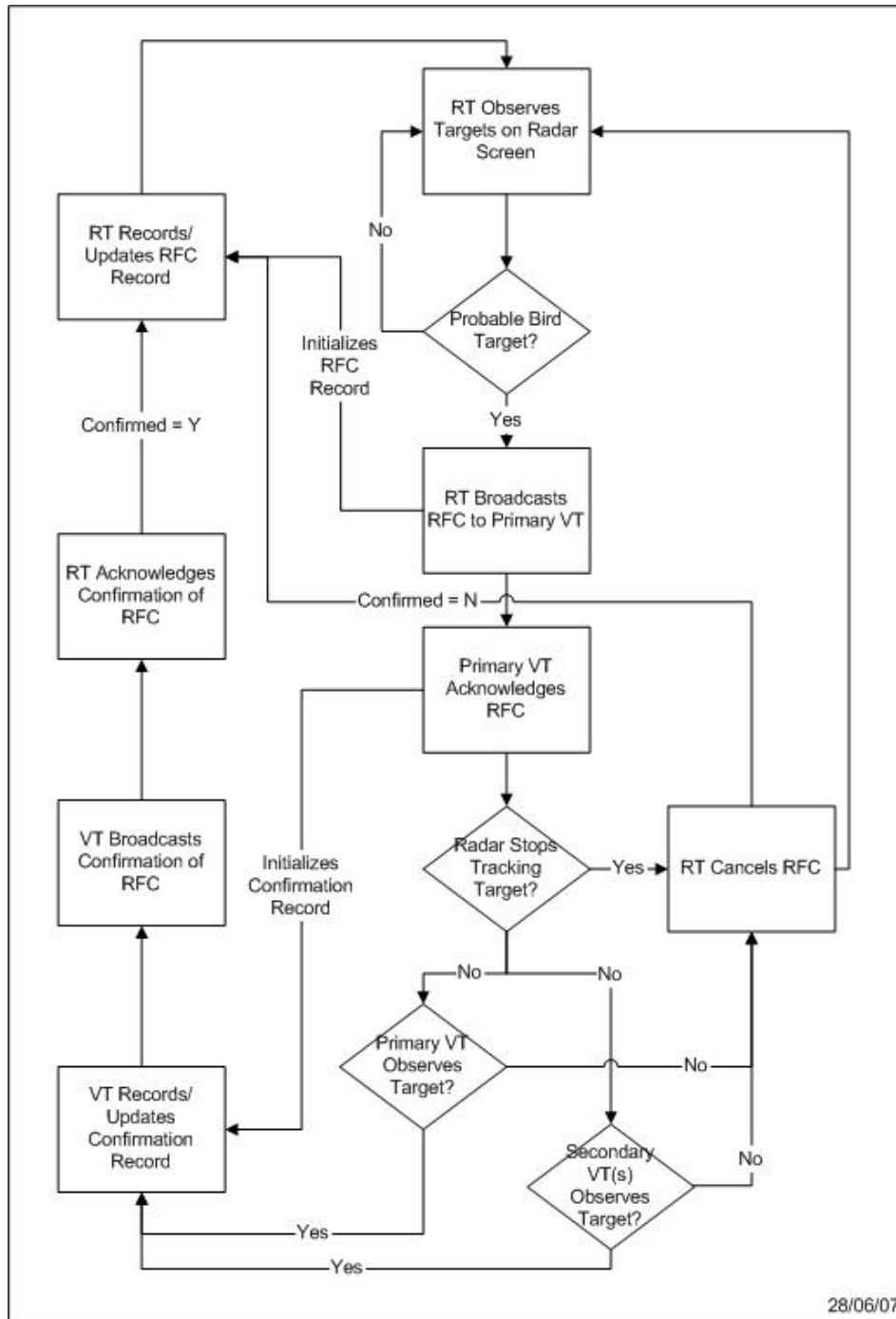

Figure B-9. Flowchart of target confirmation process. RT=Radar Team, VT=Visual Team, RFC=Request for Confirmation

Broadcast an RFC

The Radar Operator observes target tracks on the DRP monitor, looking for a target that is close to a VT site, based on its distance from that site’s placemark on the screen, and in an area that should be visible to the VT. The Operator may consider whether, based on past experience, the target is likely to remain in the radar beam long enough for the VT to locate and confirm it, and

whether other targets might be confused with the primary target. The Operator should also be mindful of the need to select targets that are near a VT site that is 2 km or more from the radar (see Performance Criterion PA4.1 in 6.1.1.4). Finally, the Operator should attempt to choose targets near all the VT sites, not just those that might be experiencing a lot of bird activity.

Once the Operator selects a potentially good target on the screen, s/he activates the “camera” button on the Accipiter® display to capture a bitmap image of the screen display and then broadcasts a Request for Confirmation (RFC) on the radio to the “primary” VT (pVT) - usually the team closest to the target. The broadcast of an RFC typically takes the form:

RT: “Team 2-Alpha, Target 23 is one-half mile south-southwest of you, near the intersection of the runways, moving west.”

Contained within this broadcast is the designation of the primary VT (VT-2A) that is being asked to confirm a target, the unique identifier of the target within the current session (#23), the range (0.5 miles, or 0.8 km) and bearing (SSW) of the target from the pVT and its heading (W), as well as a familiar land feature (intersection of the runways) the target is near.

Since all of the VTs are listening to the same broadcast, the RFC begins with the name of VT to alert them to “this RFC is for you.” The other VTs, knowing where site VT-2A is in relation to their position, could use the same information in the broadcast orient themselves to the target and attempt to confirm it too.

As the RFC is broadcast the RT Recorder begins filling in the Team Number, Target Number, Bearing, Distance, etc. on the RT Field Data Form. When the broadcast is complete, the Recorder notes the time on the digital watch³⁷ and waits for the Operator to specify the Track ID of the target. The RFC time is recorded at the end of the broadcast so it will be as close as possible to the time when the VT actually began looking for the target.

Track IDs are automatically generated by the Accipiter® DRP. The internal Track ID the DRP generates and stores is universally unique: No two DRPs would produce the same Track ID for a target. The five-digit external Track ID that is displayed on the monitor is also unique within a session (actually, for longer periods). Nonetheless, even the shorter Track ID is too long and too prone to broadcast errors for use in the radio communications between the RT and the VTs. Therefore, a two-digit, sequential Target Number is used to uniquely identify targets in all radio communications. Target Numbers are created sequentially by the RT Recorder as s/he entered a new record on the RT field data form. Target Numbers are unique within a session, and because the RT data form records both the Target Number and the Track ID, it provides the keys that link together the VT field data (Target Number), RT field data (Target Number & Track ID), and the DRP plots & tracks data files (Target ID only). The time stamp of each RFC provides a secondary link to other types of information, such as the names of the plots & tracks files generated by the DRP and the pictures of the display screen that was captured at the start of each RFC broadcast.

The pVT acknowledges the RFC broadcast:

³⁷ The RT Recorder often records the seconds portion of the RFC broadcast time first to make sure that information is captured accurately, and then adds in the hours and minutes while the RT waits for confirmation from a VT.

VT: "Radar, Team 2-Alpha copies Target 23"

and then enters the Target Number in the next record on their field data form.

Responding to an RFC

The following are the possible responses in the field to an RFC.

Abort

If the target disappears from the screen before the broadcast of the RFC is complete, or before the VTs have time to even look for the target, the RT broadcasts:

RT: "Abort Target 23"

and enters an "A" in the Confirmed? field on the RT data form. "Abort" indicates the RFC was issued and the Target Number was assigned, but there was neither a confirmation nor non-confirmation of the target.

The VT acknowledges the RFC was aborted by broadcasting:

VT: "Radar, Team 2-Alpha copies abort of Target 23."

and enters an "A" in the Confirmed? column on the VT field data form. Once the abort is acknowledged, the Radar Operator begins looking for the next target.

Non-Confirm

If the radar processor stops tracking the target and the Track ID disappears from the screen before one or more VTs can confirm it, the RT cancels that target by broadcasting:

RT: "Cancel Target 23"

and enters "N" under the Confirmed? column on the RT field data form to indicate the target was not confirmed by a VT.

The VT acknowledges the cancellation by broadcasting:

VT: "Radar, Team 2-Alpha copies cancel of Target 23."

and enters an "N" on the VT field data form. Once the cancellation is acknowledged, the Radar Operator begins looking for the next target.

Confirm

If the pVT observes a target that matches the RFC, the Observer makes a mental note of the target's position and the pVT broadcasts a confirmation

VT: "Radar, Team 2-Alpha confirms Target 23"

The VT Recorder enters “Y” for “Yes” in the Confirmed? column on the VT field data form, as well as the time on the team’s digital watch when the confirmation was made. The RT receives the confirmation broadcast from the pVT, the RT Recorder enters a “Y” under the Confirmed? column on the RT field data form for that RFC, and acknowledges the confirmation:

RT: “Radar acknowledges Team 2-Alpha confirms Target 23”

Once the confirmation is acknowledged, the Radar Operator begins looking for the next target.

As noted above, the VT Observer must make a mental note of the bird’s position when it was observed and confirmed, as the bird continues to fly off in whatever direction it was headed. Keeping his/her eye on that spot, the Observer uses the compass to get a bearing (degrees, magnetic³⁸) to that position, and then the inclinometer to get the angle of that position above the horizontal plane. Next the Observer counts (or estimates) the number of birds in the flock and identifies the birds to the lowest possible taxonomic level, usually by common name (e.g., “Canvasback Duck”, “Duck”, “Unknown Waterfowl”). For mixed flocks of two or more types of birds, the Observer should enumerate each type separately. To save time and space, the four-character USGS Bird Banding Lab codes (e.g., TUVU for Turkey Vulture) can be used to record the bird identifications. If another VT (secondary, or sVT) observes the target, they follow the same procedures as the pVT for recording the confirmation. An sVT does not, however, broadcast the confirmation to the RT unless the pVT did not confirm the target. In the case where an sVT confirms the target but the primary does not, the RT should enter on their field data form which sVT(s) confirmed the target.

If an sVT cannot confirm a target, they make no entry for that target on their field data form.

A “Y” under the Confirmed column of the RT field data form, with no further notation as to which VT confirmed the target, means the target was confirmed by the pVT. A note should be added to the RT field data form if a secondary team, or teams, confirmed the target, whether the confirmation was instead of (“Confirmed by Team [team name]”) or in addition to (“Also confirmed by Team [team name]”) the pVT.

As noted above, on occasion birds will enter the radar beam near the target being tracked, after the RT has broadcast the RFC. In these cases the RT Operator should have the RT Recorder record these additional Track IDs to the Notes field.

No new RFCs should be broadcast by the RT until the current RFC is closed (i.e., confirmed, non-confirmed (cancelled) or aborted). The time between the broadcast of an RFC and a confirmation is typically 30-45 seconds, but could last several minutes if the target remains in the

³⁸ The DRP, which uses the GPS for its coordinate information, calculates the targets’ azimuth in degrees true. The compass readings by the VTs have to be converted from degrees magnetic to degrees true by applying the published magnetic declination for the study location.

beam and the VTs have difficulty locating it. While 240 RFCs could potentially be completed in a two-hour session (2/minute X 120 minutes), a session typically yields 60-70 RFCs.

Ending a Session

This cycle is repeated until the two hours of the session has elapsed, at which point the RT broadcast to all VTs that the session had ended and the time it ended.

RT: "Session 5 has ended at zero-seven, two-six, four-nine."

Both VT and RT Recorders note the end time on their field data forms and the VTs acknowledge the end of the session.

VT: "VT-2A acknowledges Session 5 has ended."

The RT and VTs turn off the DARs and check over their field data forms.

Post-Processing the Observations

Even though everyone is tired at the end of session, it is vitally important to have a post-processing session immediately following each session, while the events and information is still fresh in everyone's minds. During the post-processing session, one representative from the RT (usually the Recorder) and one from each of the VTs meet to review the field data from that session. For each RFC, the RT representative reads out the Target Number and pVT specified in the RFC. The RT representative follows that with "Aborted" if that RFC was aborted, and the pVT representative responds "Aborted" to acknowledge an "A" was recorded on that team's field data form. If the RFC was not aborted, the representative from the pVT responds with either a "Confirmed" if the pVT confirmed that target or "Non-Confirmed" if they did not. The RT checks that the pVT's response matches what is recorded on the RT field data form for that RFC (see **Table B-1**). After the pVT responds, any sVTs that also confirmed that target respond "Confirmed by Team [team name]" and the RT checks if the sVT's confirmation is noted correctly on the radar field data sheet (**Table B-1**³⁹). Any discrepancies between the RT and VT field data forms with a comment in the Notes field of both forms that begins "PP ..." to indicate the comment was added in post-processing.

All other discrepancies between the RT and the VT field data forms should fall into one of two categories (see **Table B-1**):

H – The pVT (and sometimes all VTs) did not hear the RFC broadcast (e.g., the noise from an aircraft near a VT may have drowned out the broadcast); or

O – Any other issue that invalidated the RFC (e.g., the DRP rebooted during an open RFC).

³⁹ Blank Confirmed? values were replaced with one of three categories of incomplete RFCs codes (A=Aborted, H=did not Hear, O=Other) during the data processing stage to reduce ambiguity over why the Confirmed? field had been left blank.

Table B-1. Meaning of Confirmed? field values on the RT field data form.

Confirmed Field Is	Notes Field Includes	Meaning
Y	No comment as to which team confirmed the target	pVT confirmed the target
Y	“Confirmed by [sVT]”	sVT confirmed the target; pVT did not
Y	“Also confirmed by [sVT]”	pVT and sVT confirmed the target
N		None of the VTs confirmed the target; RFC cancelled.
H	Notes entry to the effect “VT did not hear the call”	Post-processing information that RFC was incomplete
A	Either the entire record was nearly incomplete or Notes indicated the operator had aborted the RFC.	Aborted; RFC cancelled before it could be completed
O		Other (e.g., Processor unplugged; had to reboot).

Data Processing the Observations

Once the post processing is complete, two or three pairs of team members should transcribe the data from the hardcopy field data forms into pre-formatted spreadsheets – one spreadsheet for each VT site. One member of the pair can read the data from the data form while the other member enters the data into the spreadsheet. One team member should also download the MP3 file from each of the DARs on a computer hard disk. A copy of the completed spreadsheet should then be given to a team member who has been designated to keep the originals of all project documents. A copy of each spreadsheet should be given to another team member who has been designated to keep the backup copies of all the project documents. Similarly, the hardcopy field data forms should be photocopied and the originals and copies given to the designated team members. The originals and copies of all documents should be stored in different physical locations for safety.

Further Data Processing

Once the study is complete, further processing of the data is dependent upon the objectives and resources of the project. The following procedures are those the IVAR project has used to get the field observations into a more useable form.

One team member was responsible for importing all the spreadsheets into tables into a desktop database (Microsoft Access®). Data that would not load properly from the spreadsheet to the database were corrected in the spreadsheet and reloaded until there were no loading errors. Once loaded, each table was reviewed for gross errors – missing or incomplete dates, incomplete team names, etc. Each table was then subjected to increasingly detailed quality assurance checks, looking for inconsistencies and omissions that were only apparent from examination of the contents of the other fields in that record. Finally, the edited data tables were compared back to the original hardcopy forms to look for transcription or other types of errors.

All corrections made to the data – from changes to the spreadsheet files in order to get the data to load correctly, to internal consistency checks – were documented in a Metadata table in the database. The Metadata table recorded which record in a file was changed, how it was changed,

why it was changed, who made the change, and when. With this structure it is possible to “join” and RT or VT record from a data table to the Metadata table to retrieve all changes that might were made to that record.

When the edits and quality assurance checking of the individual data tables were complete, the data records from each table were appended to either a summary table for radar observations or a summary table for the visual observations. All further processing and analysis of the data were performed on these summary tables.

Copies of all hardcopy field data forms were scanned and converted to PDF format and then uploaded to the IVAR project portal so that other members would have access to them. Likewise, all the spreadsheets into which the field data forms were transcribed, and the database into which the spreadsheet data were loaded, were uploaded to the IVAR project portal.

Examples of the typical field forms should include the following information for the selected target (i.e., Track ID) specified in an RFC:

- A “screen capture” of the eBirdRad monitor made at the time the RFC was called.
- Portions of a data file generated by the Accipiter® radar processor showing the position, speed, heading, etc. that are recorded for each detection of the specified target.
- A copy of the page from the hardcopy RT & VT field data forms.
- A listing from the spreadsheet into which the RT & VT field data were transcribed.
- Records from the database into which the field data were loaded for QA and for data analysis

Visual Confirmation of Bird Targets – Independent Observations.

The previous section describes the methods we developed for what we termed “dependent observations” – where the RT and VTs were in radio communication with one another and the RT called out the target for the VT to confirm. As noted, while the RFC could be heard by all the VTs, it was directed to specific VT, the primary VT (pVT). The other, secondary VTs (sVTs) used the information in the RFC to make a determination if it were possible for them to also confirm the target. If they thought it possible, they would look for the target and record the RFC number, time, position, etc. on their field data form if they did observe it – everything the pVT would do, only they would not broadcast a confirmation to the RT unless the pVT did not confirm the target.

If, on the other hand, any sVTs that decided they could not observe the target identified in the RFC was asked to make “independent observations” while they waited. An independent observation involved observing and recording any birds visible from their site that they thought should be in the radar beam and being tracked (and recorded) by the radar, but not included in the current RFC. The same types of information about the target were recorded in an independent observation as in a dependent observation, except there was no RFC Number to record because there had been no broadcast by either the RT or the VT regarding this target.

The goal of making the independent observations is to have the radar and the VTs independently observing the same space at the same time and recording the targets they see. Later the “plots & tracks” data files recorded by the radar can be replayed to the same time recorded on the VT’s field data form to determine if the target the VT saw was also observed and tracked by the radar.

Independent observations go beyond the basic question of whether digital DRPs can detect and track birds in real time and address questions like the relative efficiencies of visual observers and radars at sampling bird populations. The purpose of making these independent observations during the course of this study was twofold: To evaluate and refine the methods for making independent observations, and if suitable, to gather the first round of independent observations to compare with future studies by the IVAR project.

METHOD #4: CONFIRMATION OF BIRD TARGETS USING THERMAL IMAGING

Thermal imaging is a relatively recent addition to the toolkit of biologists trying to detect and identify birds and bats flying in the atmosphere (see Gauthreaux and Livingston 2006). Unlike image intensification or infrared detection where the organism must be illuminated by an external source for detection, the heat signature from the organism is detected by an array of thermal sensors and displayed in the form of a video image. Consequently, the behavior of the organism is not affected by illumination. By recording the video images one can document the occurrence of insects, birds, and bats in the atmosphere (Gauthreaux and Livingston 2006). By combining vertically pointing thermal imaging camera and vertically pointing radar, one can record the thermal data from the organism and in many instances identify whether the organism is a bat, bird, or insect and also determine the altitude of the organism using the vertically pointing radar as a range finder.

The methods described below are designed to use the thermal imager-vertically pointing radar (TI-VPR) to confirm that targets being tracked by an avian radar unit are biological targets, including birds. These methods can be employed night or day, but are particularly effective at night when visual confirmation methods (Method #3) cannot be used.

Equipment

For the methods described in this section, the eBirdRad radar was the same as those used in other IVAR confirmation studies: A Furuno model FR2155-BB X-band radar with a parabolic antenna. However, the parabolic antenna on the eBirdRad unit had a beam width of 2.5° , rather than the 4° beam antenna used elsewhere. The plots and tracks data of the targets tracked by the eBirdRad unit are recorded by the Accipiter® DRP on a local hard drive. The TI-VPR system (Figure B-10) includes a 50 kW Furuno X-band radar (model FR 2155-BB) with a 1 meter parabolic reflector antenna pointed vertically, together with a vertically pointing thermal imaging camera (Raytheon model Radiance I).



Figure B-10. The TI-VPR sensors: A Furuno FR2155-BB 50 kW X-band radar with a vertically-pointing parabolic dish (left), and Radiance I high-resolution thermal imaging camera (right).

The schematic for the recording of the data generated by the TI-VPR is shown in Figure B-11. A video camera is positioned in front of the radar screen to record the images it displays. Video from this camera is sent to a date and time generator, and from there to one input of the video multiplexer (Colorado Video model 496-2C Video Signal Multiplexer (2 Channel)). Video from the thermal imaging camera is sent to the second multiplexer input, and the video from the multiplexer is recorded directly to a DVD (high definition capacity 1 hr) using a Sony DVD recorder (model VRD-MC5). Figure B-12 shows a multiplexed image.

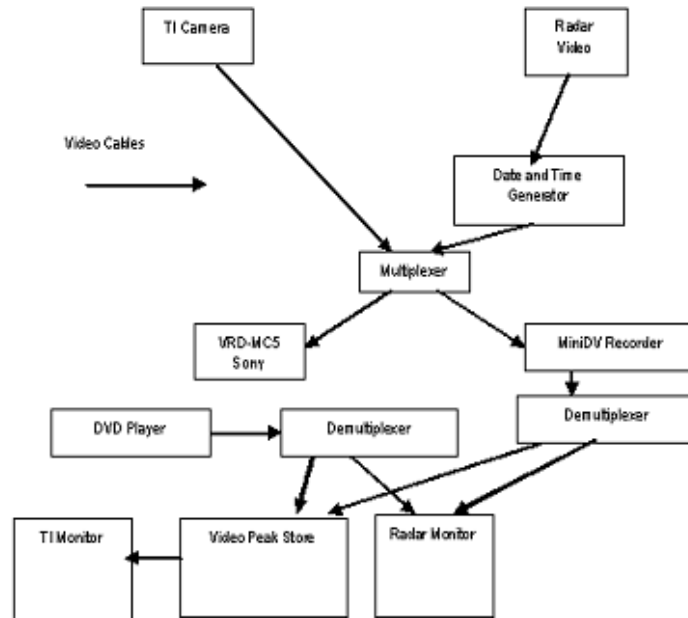

Figure B-11. Diagram of data acquisition system for the thermal imaging camera and vertically pointing radar system.



Figure B-12. Duplexed image showing radar image with date and time stamp (left) and thermal imaging camera display (right). Because the two images are video-duplexed, time synchronization is not a problem.

Standard Operating Procedures

The vertically pointing radar component of the TI-VPR is calibrated by pointing the radar at a known, fixed target (ground clutter) and measuring the strength of the return signal while using fixed video gain and brilliance settings. The thermal imager component is calibrated according to the manufacturer's instructions. Video settings are checked and standardized with respect to brightness and contrast. The radar range is set to an appropriate value (e.g., 2.8 km (1.5 nmi) with 463 m (0.25 nmi) range marks) and the parabolic antenna is pointed vertically. The thermal imaging camera is placed within 1 m of the radar antenna and directed vertically such that the beam of the radar and the field of view of the thermal imager overlap. The longitude and latitude coordinates of the TI-VPR are recorded from the GPS and the time on the date/time generator is set to the time (GMT) supplied by the GPS .

Plots and track data from the eBirdRad unit are recorded continuously throughout the study period, while several hourly samples of TI-VPR data are collected during this period (**Table B-1** shows the sampling periods used for the IVAR studies). In the examples used here, the distance (1295 m) between the eBirdRad and the TI-VPR required that the eBirdRad antenna be elevated to 20° and 30° above horizontal in order that the radar beam would be high enough to adequately sample migrating birds in both systems (

Table B-2; see also **Table B-3**). In addition, because thick cloud cover generates a substantial heat signature that obscures the thermal signatures of targets detected by the TI-VPR, samples should be gathered when thick cloud cover is not present.

Table B-2. Dates, times, and antenna angles of the TI-VPR recording sessions.

Date	Time (GMT)	Angle	Comments
2 Oct 2008	22:21-23:22	30°	
3 Oct 2008	01:49-02:52	30°	
3 Oct 2008	15:07-16:11	20°	
3 Oct 2008	16:15-17:17	20°	
3 Oct 2008	19:23-20:26	20°	
4 Oct 2008	01:15-02:17	20°	until 01:30
		30°	after 01:30
4 Oct 2008	19:48-20:52	20°	
5 Oct 2008	00:48-01:50	30°	

Data Analysis

For analysis, the DVD containing multiplexed TI-VPR data is inserted into a DVD player and the output signal sent to a demultiplexer (Colorado Video model 497-2C 2-channel Video Demultiplexer (Figure B-11)). The output channel for the thermal imager is sent from the demultiplexer to a video peak store (VPS; Colorado Video model 443 Video Peak Store), and from there to a video monitor. The VPS stores a new incoming pixel if it is brighter than the corresponding pixel already stored in frame memory and can show the track of a bright (warm) target as it moves over a dark (cool) background (Figure B-13). The output channel for the vertically-pointing radar display is sent from the demultiplexer directly to a second video monitor (Figure B-14). As a biological target passes through the field of view of the thermal imager, the altitude of that target is displayed as a bright arc or circle on the radar screen. The date and time stamp on the radar video display is from the GPS.

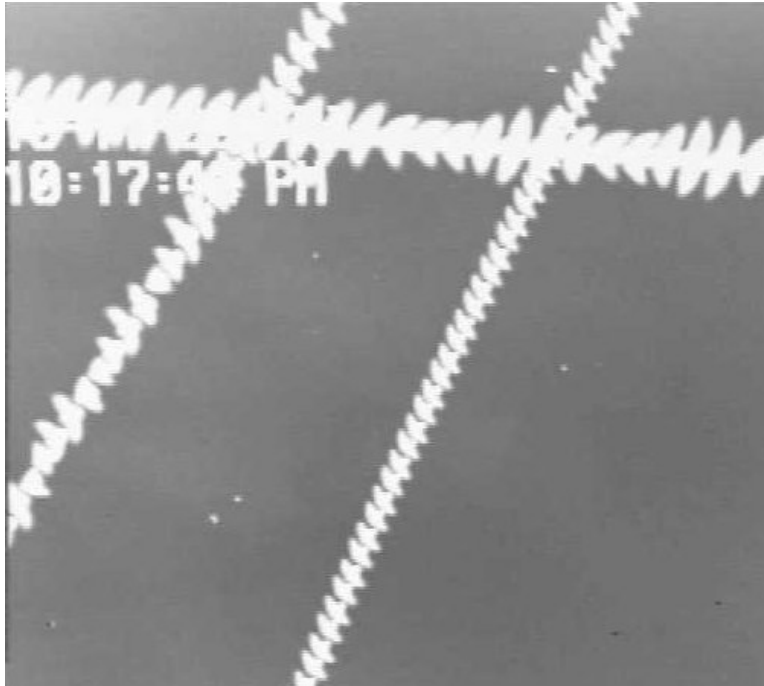

Figure B-13. Video Peak Store time exposure showing flight trajectories of birds overhead



Figure B-14. Dual display of video from thermal imager (left) and vertically-pointing radar (right).

For each target detected by the TI-VPR during playback and analysis, the following information is recorded: Date, time, identification, number of individuals, direction of movement, altitude above radar level (taken from the simultaneous radar video display). Special data on target behavior (e.g., circling, zigzag flight, hovering) is entered into the comments column of the data sheet for that detection. The identification criteria used in the IVAR studies were the same as those detailed in Gauthreaux and Livingston (2006).

For the analysis of the simultaneous samples from the eBirdRad unit, the alarm feature of the Accipiter® TVW is used to center a 0.25 km radius polygon over the position of the TI-VPR site on the display; only the birds that pass through this polygon are used to compute the number of tracks identified as birds recorded per minute. The location of the polygon is adjusted for the eBirdRad antenna elevation angle such that it is located at the same position over the ground even though the slant range differed between antenna angles (Figure B-15 for the 20° antenna elevation, and Figure B-16 for the 30° antenna elevation).

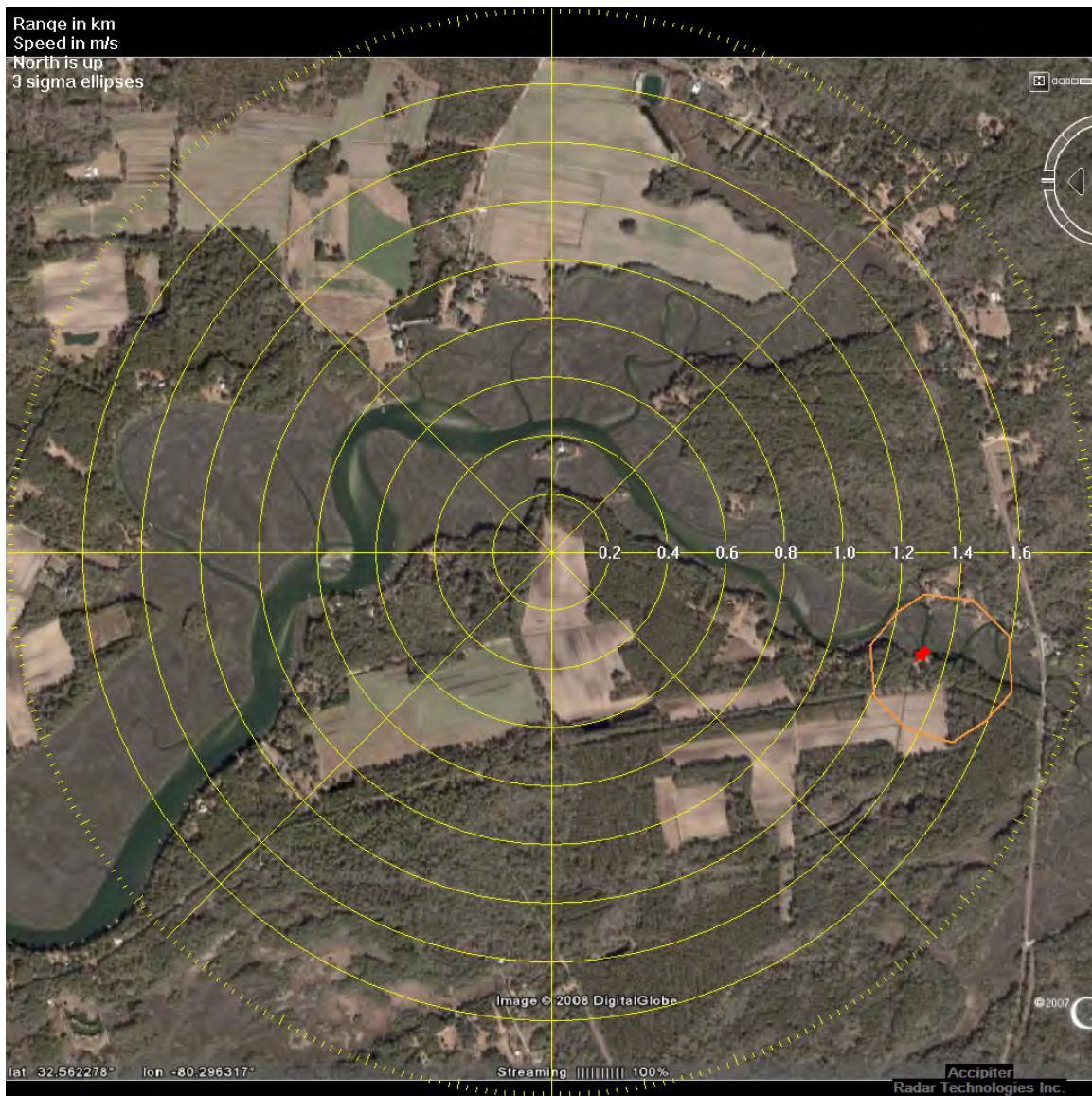

Figure B-15. The polygon around the red pushpin delimits the sample area for the eBirdRad data collected with a 20° tilt.

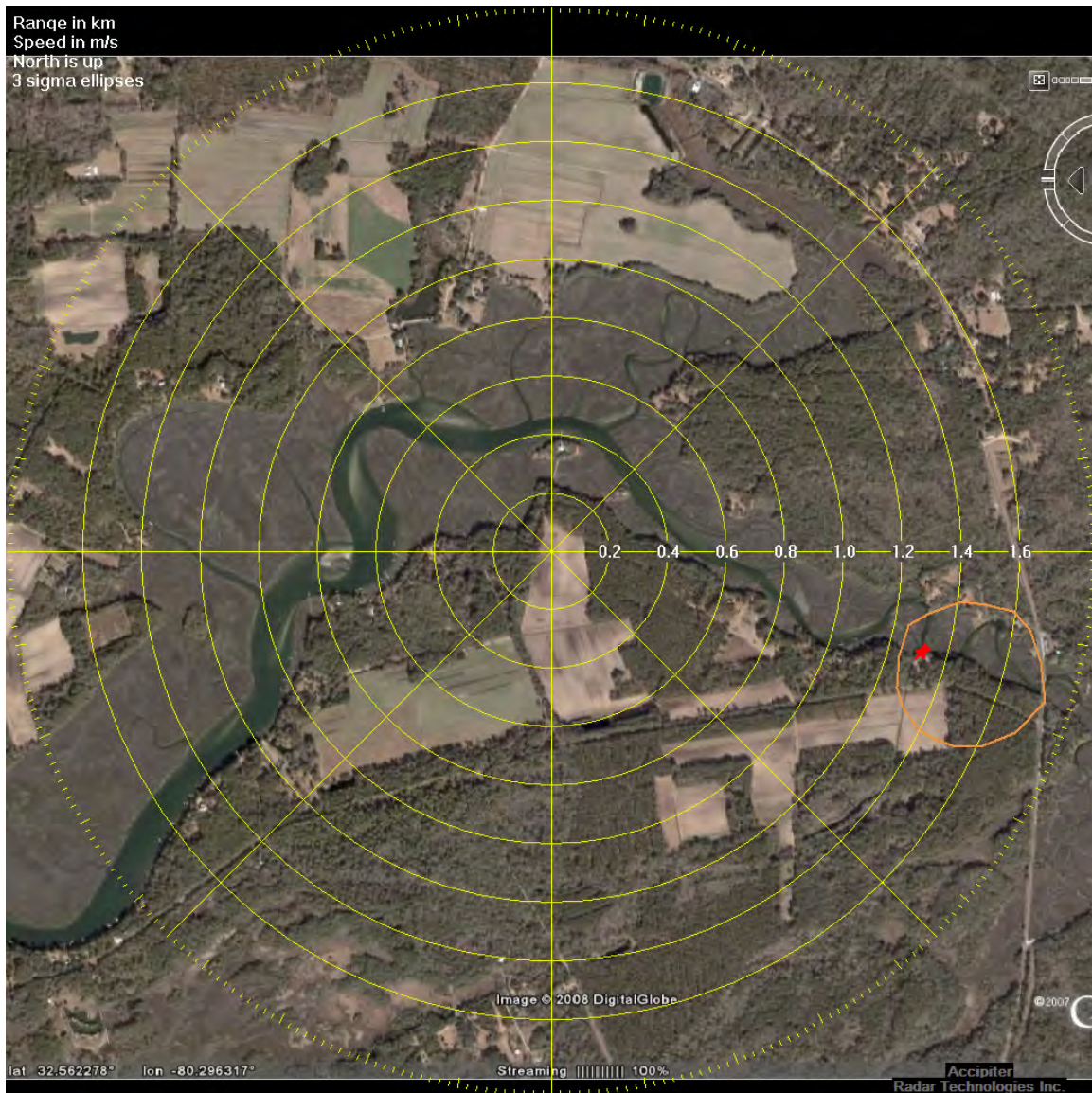

Figure B-16. The polygon around the red pushpin delimits the sample area for the eBirdRad data collected with a 30° tilt.

The TVW has a “speed filter” feature that can be set to remove from further processing the tracks of targets that are moving above or below a specified speed. The speed filter was not used to remove insect and other targets that were moving about the same speed as the wind, but a filter was used for targets traveling more than 40 m/s to prevent the generation of tracks produced by aircraft. Insect tracks were identified based on speed on a track-by-track basis. Bats were distinguished by their erratic tracks and sharp turns. The sampling volumes of the two devices were calculated based on their characteristics (**Table B-3**).

Table B-3. Altitude of the radar beam (500 m diameter) over the thermal imager and the diameter of the TI's field of view at those altitudes.

Angle (range)	Beam altitude	TI diameter
20° (18.75 – 21.25°)	444 – 500 m	31 – 35 m
30° (28.75 – 31.25°)	721 – 778 m	50 – 54 m

The eBirdRad radar data are evaluated for the periods when the thermal imager is active (

Table B-2). This was done by first tabulating the number of birds on a minute-by-minute basis for both the eBirdRad and TI-VPR. These one-minute tabulations were then grouped into 5-minute subsamples. The results of all 5-min subsamples for each hourly session were then summed to calculate the hourly rates of movement.

It is difficult to use the methods described here to relate a single target in the TI-VPR to the same target track in the eBirdRad data because:

- Both the eBirdRad and the TI-VPR radars have an approximately 2.5-second time delay in updating target position data due to the fixed scan period of the radars. Thus, in the worst case the two radars could be as much as 5 seconds out of phase with one another.
- It takes several scans (nominally, three) for the DRP's tracking algorithm to determine whether a pattern of detections for a target warrants elevation to a confirmed track. This can add another ~8 seconds to the time uncertainty between the eBirdRad and TI-VPR tracks for a given target.
- The complications of these factors are compounded when a large number of birds are flying and being sampled by both systems.

For these reasons, the TI-VPR is best used to confirm that targets recorded by the avian radar are birds by correlating the counts of birds passing through the field of view of the thermal imager with the counts of tracks from eBirdRad that passed through a sample polygon on the radar display (see Figure B-15 and Figure B-16) for the 5-minute and 1-hour time segments described below.

The following four types of analyses were conducted to confirm by thermal imagery the targets being tracked at night by eBirdRad were birds. The colors used in the description of the each analysis refer to colors used in Figure B-17 to denote different segments of coverages by the eBirdRad and Ti-VPR systems.

1. Compared 5-min segments of eBirdRad and TI-VPR data, overall (green, yellow, and red).
2. Compared 5-min segments of TI-VPR birds at the same altitude as the radar beam (yellow).
3. Compared 1-hour sessions for TI bird counts, overall (green, yellow, and red).
4. Compared 1-hour segments for TI birds that are at the same altitude as the radar beam (yellow).

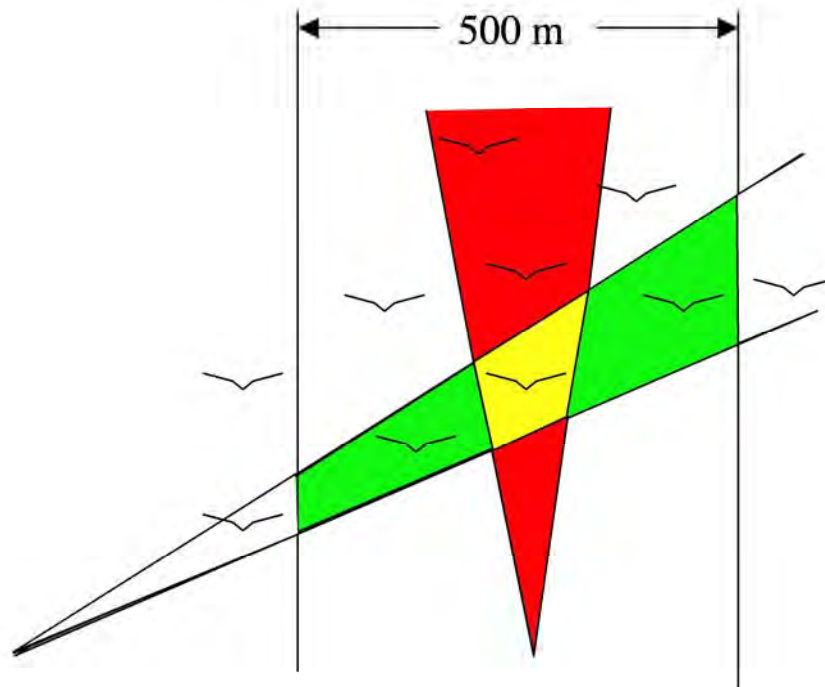

eBirdRad

Thermal Imager &
Vertically-pointing Radar

Figure B-17. Diagram of sampling “volumes” of eBirdRad and the TI-VPR. The green and yellow denote the sampling volume of the eBirdRad and the red and yellow the sampling volume of the TI-VPR. The yellow indicates the sampling volume of the thermal imager that is within the coverage of eBirdrad. The vertical gray lines represent the edge of the eBirdRad sample polygon depicted in Figure B-15 and Figure B-16.

METHOD #5: AUTOMATIC TRACKING OF UNMANNED AERIAL VEHICLES (UAV).

Remote controlled helicopters (RCH) can be used to validate that the automatic tracking coordinates produced by the digital radar processor (DRP) used in eBirdRad and the AR-1 and AR-2 radars are accurate within sensor resolution limits. By placing a GPS onboard the RCH, the coordinates of the RCH during flight tests can be recorded and compared subsequently to radar tracks of the RCH produced by the radar. The method can be described as follows:

1. Fly the RCH within the coverage zone of the radar and at detectable ranges recording the helicopter's trajectory with onboard GPS
2. Operate the radar to track RCH - record raw data for subsequent reprocessing
3. Extract helicopter trajectory coordinates from GPS and provide in suitable format
4. Extract helicopter radar track coordinates by reprocessing raw radar data and outputting helicopter tracks
5. Compare radar track coordinates and GPS coordinates by overlaying onto common graph or display
6. Analyze radar and GPS coordinates and assess accuracy given sensor resolution limits

Achieving (1) above is perhaps the most challenging part of the method. An RCH is typically small, and if it is flown at any significant distance from the radar (say 1-2 km), then the radar operator will likely not be able to see the helicopter. It is also difficult for the RCH pilot to estimate the height of the RCH needed to ensure that the helicopter is flying in the radar beam. As a result, it can be quite challenging for the radar operator and pilot to ensure that the helicopter remains in the radar beam for sufficient time to collect meaningful data. This is particularly true at locations such as commercial airports (e.g., Seattle Tacoma International Airport) where the radar location is fixed, and where authorizations to fly the RCH are provided only at certain locations.

Recording raw data throughout the test ensures that whenever the helicopter was in the beam of the radar (to be confirmed off-line through analyses of the GPS coordinates), the radar data is available for comparison.

If the RCH dynamics can be reasonably controlled to mimic birds in flight, and if the RCH remains in the beam for sufficient periods of time, then radar tracks can be compared directly against the GPS coordinates; otherwise, radar detections can be compared against GPS coordinates.

METHOD #6: DEMONSTRATING REAL-TIME DATA FUSION.

Method #6 is intended to demonstrate that in spite of the fact that any pair of avian radars are asynchronous temporally (they have independent time sources) and spatially (they rotate independently and asynchronously and are displaced in space), they can be reasonably aligned so as to provide meaningful improvements when their radar tracks are combined through integration or fusion.

Spatial Alignment Procedure (SD3.1)

1. Use a pair of radars with overlapping coverage.
2. Review recorded track datasets using the TrackViewer's playback feature to identify at least three timeframes where one or more targets were tracked simultaneously by both radars for a duration of at least 10 track updates (i.e., a minimum of 30 pair-wise comparisons of target positions between the two radars); note the TrackIDs of the respective track pairs.
3. Extract the respective track pairs as follows: Load the track data from each radar into the TrackDataViewer. For each radar, select the identified tracks from each of the three selected timeframes using the TrackID and export the updates for these tracks into a spreadsheet using the export feature of the TrackDataViewer. Also export the same data into a KML format for visual comparisons of the track pairs in GoogleEarth™.
4. Organize the respective track pairs into adjacent columns of the spreadsheet so that their spatial positions can be easily compared.
5. Compute the signed distance between each pair of spatial positions of the target(s) from the two radars. The *spatial misalignment error* is the absolute value of the mean of these paired differences.
6. Define the *a priori spatial uncertainty* as the sum of: a) The range-resolution of the radar (use the larger value if the radars are different); b) The maximum cross-range-resolution for the track pair (taken as the maximum of the point-wise range*azimuth-beamwidth); and c) The maximum-speed of the target (taken from the track pair) multiplied by twice the scan-time uncertainty of 5 seconds.
7. If the spatial misalignment error is <3 times the a priori spatial uncertainty, the two radars are spatially aligned within acceptable error.

If the opportunity allows, fly a UAV (e.g., remote-controlled model airplane, or RC) in the coverage area of a pair of radars. The RC aircraft would carry an independent GPS to log its own true track. Compare directly the RC aircraft true track with each of the radar tracks and measure the spatial alignment errors as defined above.

Temporal Alignment Procedure (SD4.1)

1. Use two radars with overlapping coverage that employ a Network Time Protocol (NTP) server as the time source to keep the two radars' DRPs reasonably aligned temporally.
2. Identify a one-week time period where the DRPs for both radars were running and recording .tracks data files locally and streaming tracks to an RDS.
3. Extract time stamps (scan times) for each of the two radars over the one-week period. This can be done using the RDS Admin tool, which can extract successive entries in the RDS from the pair of radars.

4. Extract a one-hour time segment at each of the beginning, middle, and the end of the one-week period. Each one-hour segment will have approximately 1500 radar scans for each radar.
5. Load the extracted scan times for the pair of radars into a spreadsheet for comparison.
6. Analyze time differences (ignoring missed entries) between radars by computing for each one-hour segment the average pair-wise time difference between successive radar scan times. This average time difference is a measure of the *temporal misalignment* for the given one-hour segment.
7. The maximum temporal misalignment computed for any one-hour segment should not exceed two (2) times the scan-period which equals $2 * 2.5 = 5$ seconds. In other words, the pair of radars over the one week period should remain time aligned as measured in the RDS to within 5 seconds or two scan periods, accounting for differences in latencies between the pair of radars.

Fusion Processing Procedure (SD5.1)

1. Identify at least five paired sets of time-aligned track data from two radars with overlapping coverages that include simultaneous tracking of the same target(s). From each paired set of track data, select a segment that includes the simultaneously tracked targets and has a duration of at least 5 minutes. Record the duration of each of the five paired segments of track data (i.e., the five “datasets”) to the nearest second.
2. Repeat Step #3 through Step #7 below for each of the five paired datasets
3. Use the Multi-Radar Fileserver to serve the paired target track data to the Radar Fusion Engine, or RFE (ARTI beta software).
4. Press the start button on the RFE to begin processing the paired track data, while at the same time activating a timer to record the RFE processing time. The RFE will associate overlapping duplicate tracks to filter them so as to demonstrate the elimination of track duplicates. The RFE will also demonstrate in the same manner the increase in track continuity afforded by fusion.
5. Display the original paired tracks and resulting fused tracks (see Nohara, et al., 2008) using the RFE’s display capabilities to capture the above demonstrations and report on them.
6. Stop the timer when the RFE completes the processing of the paired track data. Record to the nearest second the time the RFE required to process the paired track data.
7. Compare the RFE processing time as measured by the timer in Step #6 with the real-time duration of paired track data as recorded in Step #1. The RFE processing time should be less than or equal to the real-time duration of the paired track data.

APPENDIX C. DATA QUALITY ASSURANCE/QUALITY CONTROL PLAN

Quality Assurance Narrative Statement:

The proposed research will conform to published agency guidance. Considering the field-based data collection activities, a model in the USEPA policy statements provided by the National Center for Environmental Research and Quality Assurance will be used for this project. Specific quality assurance program elements will be based on the latest version of EPA QA/R-5, Requirements for Quality Assurance Project Plans.

Quality Assurance (QA) on this project has two elements. The first is the QA program implemented by project principals, the second is a QA program monitoring conducted by a Unit QA officer. Program implementation is described below. The Unit QA officer, Mr Gerry Key will provide monitoring to assure that the QA plan and QA activities conform to published guidance.

Activities performed, hypotheses tested, and criteria for determining the acceptability of data quality.

This research is designed to collect new data and will use existing data resources, modeling approaches, and other methods to validate the use of radar systems in natural resources management (NRM) and Bird Aircraft Strike Hazard (BASH) activities. Hypotheses to be tested are associated with the performance of radar systems, and individual system technologies in the detection and tracking of bird targets, and the validation steps necessary to assure utility to NRM and BASH programs. As part of quality assurance plans, all data collection activities will be guided by defined performance criteria as presented in "Field Demonstrations of the Operational Capabilities of Digital Avian Radar Systems. The acceptability of data quality will be judged against defined performance objectives.

The study design

The project has a study design intended to fully validate the use of avian radars in NRM and BASH applications. An initial QA element of this project is the review of this proposal and a ESTCP review of the initial report and demonstration plan submission. QA elements also include development of a quality assurance program by project principals, regular review by collaborators so that focus on critical issues is maintained throughout the project, and the review of the Unit QA officer to assure overall project conformance with QAPP requirements.

Procedure for handling and custody of samples

This research will involve field sampling and a protocols and procedures will be developed based on objectives and performance criteria. All data sources will be identified, catalogued, and documentation will be kept listing data use in each of the modeling/analysis steps of the validation program.

Methods used for analysis of samples

There are two phases of data analysis proposed in this project. The first addresses the issue of radar system capability to detect bird targets. In this phase, dependent and independent observations will be made of radar data products to validate observation enhancements provided by the radar. In the second phase, all elements of data management including data streaming and integration will be subject to performance assessments based on identified criteria.

Procedures used in the calibration and performance evaluation of analytical methods

The primary procedure used in model calibration will be comparison of results to historical data, and general sensitivity analysis based on collaborator input. All other analytical methods will be subject to testing and verification as a part of the overall study design. Where possible, proven methods will be used, and/or adapted to meet specific validation needs of this project.

Procedures for data reduction and reporting, including, description of statistical analyses to be used

Systematic data archiving and reporting protocols will be established to provide a consistent and accurate record of project findings. The project will employ Microsoft Excel, Word, and Access formats for spreadsheet, word processing, and data-base applications. The complete project record will be prepared in Acrobat format to provide ready access by the wider scientific community. .

Intended use of the data as they relate to the study objectives and hypotheses.

The intended use of the data is to determine the utility of radar systems data products to NRM and BASH efforts on military lands. The approach adopted is a "bottom-up" approach, initiating project activities based on user requirements and then testing of project products with user groups.

Plans for peer reviews of study design or analytical methods prior to data collection

The proposed study plans will be reviewed with experts. These experts are presently members of the IVAR project team. As needed reviews will be conducted by users. As needed reviews will be conducted by professionals and organizations with expertise related to project elements

APPENDIX D. SUPPORTING DATA

D.1 Parametric Data for 234 Targets Tracked Simultaneously by eBirdRad.

Table D-1 includes the detailed data for the 234 targets tracked simultaneously at Edisto Island, South Carolina on 4 October 2008 during a single scan of the radar, between 01:18:20 and 01:18:22 UTC. These data were generated by the TDV software and were used in the demonstration of Performance Criterion PA3.1, Track Capacity (see Section 6.1.1.3). Refer to

Table 6-8 for a definition of the column headings that appear in **Table D-1**.

Table D-1. The position and behavioral data for 234 targets being tracked simultaneously at Edisto Island, South Carolina, 4 October 2008. The data listed are for the tracks displayed in Figure 6-22 and are for the time interval 01:18:20 to 01:18:22 UTC (i.e., a single antenna revolution).

Date	Track ID	Update Time	Range (m)	Azimuth (deg.)	Height (m)	Heading (deg.)	Speed (m/s)	Latitude	Longitude
10/4/2008	0	1:18:21	748	106	256	347	7.8	32.5611	-80.2897
10/4/2008	1	1:18:21	586	126	200	249	6.4	32.5598	-80.2923
10/4/2008	3	1:18:20	502	17	172	26	8.0	32.5672	-80.2958
10/4/2008	11	1:18:20	249	338	85	30	2.6	32.5650	-80.2983
10/4/2008	14	1:18:20	1965	53	672	289	5.5	32.5735	-80.2806
10/4/2008	17	1:18:21	2234	90	764	346	22.2	32.5628	-80.2735
10/4/2008	20	1:18:21	3643	116	1246	154	11.8	32.5487	-80.2623
10/4/2008	21	1:18:21	4235	121	1448	197	11.0	32.5431	-80.2587
10/4/2008	25	1:18:21	2610	122	893	198	11.2	32.5504	-80.2738
10/4/2008	26	1:18:21	4169	129	1426	190	11.2	32.5393	-80.2627
10/4/2008	27	1:18:21	4888	132	1672	187	8.2	32.5335	-80.2585
10/4/2008	29	1:18:21	5055	124	1729	184	13.9	32.5372	-80.2528
10/4/2008	32	1:18:21	2959	144	1012	202	11.7	32.5414	-80.2787
10/4/2008	33	1:18:21	5351	138	1830	203	12.5	32.5271	-80.2591
10/4/2008	34	1:18:21	1161	174	397	48	9.8	32.5525	-80.2960
10/4/2008	36	1:18:21	1336	197	457	325	7.8	32.5513	-80.3014
10/4/2008	38	1:18:21	1757	198	601	241	7.5	32.5478	-80.3030
10/4/2008	40	1:18:22	1870	204	640	208	5.6	32.5475	-80.3054
10/4/2008	42	1:18:21	3296	164	1127	253	13.9	32.5344	-80.2875
10/4/2008	45	1:18:22	454	212	155	21	5.7	32.5594	-80.2999
10/4/2008	48	1:18:22	949	217	324	11	6.8	32.5561	-80.3034
10/4/2008	49	1:18:22	2731	209	934	214	10.5	32.5414	-80.3115
10/4/2008	50	1:18:22	537	219	184	19	3.2	32.5592	-80.3009
10/4/2008	51	1:18:21	4318	126	1477	191	12.5	32.5401	-80.2601
10/4/2008	56	1:18:22	1604	204	549	91	10.1	32.5497	-80.3042
10/4/2008	58	1:18:22	3084	242	1055	164	15.5	32.5497	-80.3262
10/4/2008	72	1:18:22	954	296	326	15	8.7	32.5666	-80.3065
10/4/2008	73	1:18:22	1720	335	588	292	6.0	32.5770	-80.3051
10/4/2008	75	1:18:20	2712	346	928	251	7.4	32.5866	-80.3045
10/4/2008	76	1:18:20	1612	350	551	312	3.1	32.5772	-80.3002
10/4/2008	79	1:18:20	2851	342	975	201	10.8	32.5873	-80.3068

Table D-1 (cont.).

Date	Track ID	Update Time	Range (m)	Azimuth (deg.)	Height (m)	Heading (deg.)	Speed (m/s)	Latitude	Longitude
10/4/2008	84	1:18:20	2883	54	986	235	9.8	32.5782	-80.2725
10/4/2008	88	1:18:20	2479	64	848	205	10.0	32.5728	-80.2737
10/4/2008	91	1:18:20	3781	55	1293	175	18.3	32.5826	-80.2644
10/4/2008	92	1:18:20	959	61	328	352	6.5	32.5671	-80.2884
10/4/2008	95	1:18:20	3356	66	1148	141	20.3	32.5753	-80.2647
10/4/2008	97	1:18:22	2899	326	992	224	12.3	32.5845	-80.3147
10/4/2008	106	1:18:21	2935	79	1004	213	10.9	32.5681	-80.2667
10/4/2008	108	1:18:20	2413	4	825	263	15.0	32.5846	-80.2957
10/4/2008	110	1:18:20	866	338	296	7	5.4	32.5701	-80.3009
10/4/2008	117	1:18:22	2300	332	787	241	12.2	32.5812	-80.3089
10/4/2008	121	1:18:21	2538	140	868	203	9.3	32.5454	-80.2800
10/4/2008	122	1:18:21	1060	85	362	357	7.7	32.5638	-80.2861
10/4/2008	125	1:18:21	2779	86	951	203	11.0	32.5646	-80.2678
10/4/2008	134	1:18:20	3787	349	1295	204	9.9	32.5964	-80.3051
10/4/2008	135	1:18:21	1642	178	562	210	3.0	32.5481	-80.2967
10/4/2008	137	1:18:21	3546	186	1213	226	10.6	32.5311	-80.3012
10/4/2008	138	1:18:21	1582	151	541	302	5.5	32.5504	-80.2892
10/4/2008	139	1:18:21	863	149	295	3	6.8	32.5562	-80.2927
10/4/2008	143	1:18:21	1810	176	619	57	5.2	32.5466	-80.2959
10/4/2008	144	1:18:21	2474	184	846	211	9.1	32.5406	-80.2990
10/4/2008	146	1:18:21	1262	191	432	336	12.5	32.5517	-80.3000
10/4/2008	148	1:18:21	1984	146	679	203	6.2	32.5481	-80.2854
10/4/2008	150	1:18:21	648	198	222	70	16.8	32.5573	-80.2995
10/4/2008	159	1:18:21	1860	164	636	262	9.5	32.5468	-80.2918
10/4/2008	160	1:18:22	1127	268	385	85	4.5	32.5624	-80.3093
10/4/2008	166	1:18:22	2166	300	741	223	12.6	32.5728	-80.3172
10/4/2008	168	1:18:22	4091	295	1399	190	17.4	32.5782	-80.3370
10/4/2008	172	1:18:22	3609	328	1234	167	9.6	32.5903	-80.3180
10/4/2008	174	1:18:20	795	337	272	52	10.8	32.5695	-80.3006
10/4/2008	176	1:18:22	2815	281	963	234	12.0	32.5675	-80.3268
10/4/2008	180	1:18:20	743	3	254	64	9.5	32.5696	-80.2969
10/4/2008	188	1:18:22	1389	297	475	224	6.5	32.5686	-80.3105
10/4/2008	193	1:18:21	4755	82	1626	206	11.6	32.5687	-80.2472
10/4/2008	194	1:18:21	3464	82	1185	203	8.3	32.5670	-80.2608
10/4/2008	196	1:18:21	3577	72	1223	193	10.6	32.5730	-80.2612
10/4/2008	199	1:18:20	422	63	144	315	8.6	32.5646	-80.2933
10/4/2008	207	1:18:21	1189	191	407	301	14.5	32.5524	-80.2997

Table D-1 (cont.).

Date	Track ID	Update Time	Range (m)	Azimuth (deg.)	Height (m)	Heading (deg.)	Speed (m/s)	Latitude	Longitude
10/4/2008	209	1:18:21	1154	133	395	58	11.7	32.5558	-80.2883
10/4/2008	212	1:18:21	1194	95	408	5	7.9	32.5619	-80.2847
10/4/2008	215	1:18:20	2951	55	1009	249	9.7	32.5782	-80.2717
10/4/2008	220	1:18:21	1302	134	445	342	2.6	32.5547	-80.2874
10/4/2008	221	1:18:21	734	126	251	20	9.1	32.5590	-80.2910
10/4/2008	222	1:18:22	1193	272	408	56	5.4	32.5632	-80.3100
10/4/2008	226	1:18:21	4246	162	1452	210	11.4	32.5265	-80.2831
10/4/2008	229	1:18:21	5687	152	1945	198	7.9	32.5175	-80.2691
10/4/2008	230	1:18:21	2739	130	937	204	12.6	32.5471	-80.2750
10/4/2008	231	1:18:21	4428	177	1514	230	9.1	32.5230	-80.2951
10/4/2008	241	1:18:21	703	193	240	31	6.9	32.5567	-80.2990
10/4/2008	243	1:18:21	2740	152	937	221	11.5	32.5410	-80.2838
10/4/2008	250	1:18:21	2504	174	857	261	11.1	32.5404	-80.2945
10/4/2008	252	1:18:20	826	307	283	17	12.9	32.5674	-80.3044
10/4/2008	254	1:18:22	941	305	322	31	10.3	32.5678	-80.3055
10/4/2008	257	1:18:22	882	329	302	43	6.0	32.5697	-80.3021
10/4/2008	258	1:18:21	2043	190	699	231	7.2	32.5448	-80.3012
10/4/2008	261	1:18:20	808	352	276	65	7.1	32.5701	-80.2986
10/4/2008	262	1:18:20	3943	348	1349	100	17.3	32.5977	-80.3060
10/4/2008	264	1:18:21	3258	127	1114	217	7.6	32.5451	-80.2697
10/4/2008	265	1:18:21	5431	129	1858	195	14.1	32.5318	-80.2527
10/4/2008	268	1:18:21	849	142	291	279	9.8	32.5569	-80.2918
10/4/2008	275	1:18:22	2918	335	998	235	3.7	32.5867	-80.3106
10/4/2008	279	1:18:21	5186	139	1774	204	11.8	32.5276	-80.2611
10/4/2008	282	1:18:21	812	195	278	13	7.5	32.5558	-80.2995
10/4/2008	290	1:18:22	864	226	295	9	6.6	32.5574	-80.3039
10/4/2008	293	1:18:20	749	57	256	0	9.5	32.5666	-80.2907
10/4/2008	297	1:18:22	853	267	292	98	3.2	32.5625	-80.3064
10/4/2008	302	1:18:21	1381	184	472	156	6.1	32.5505	-80.2983
10/4/2008	309	1:18:22	1296	322	443	43	8.0	32.5722	-80.3058
10/4/2008	311	1:18:22	5020	328	1717	205	15.0	32.6012	-80.3259
10/4/2008	312	1:18:21	4374	115	1496	181	11.9	32.5465	-80.2550
10/4/2008	324	1:18:22	2530	205	865	115	8.5	32.5422	-80.3087
10/4/2008	334	1:18:21	3915	201	1339	248	5.8	32.5299	-80.3121
10/4/2008	336	1:18:22	2629	203	899	217	9.7	32.5411	-80.3082
10/4/2008	347	1:18:22	852	263	291	260	5.6	32.5619	-80.3063
10/4/2008	350	1:18:22	459	266	157	277	7.9	32.5626	-80.3022

Table D-1 (cont.).

Date	Track ID	Update Time	Range (m)	Azimuth (deg.)	Height (m)	Heading (deg.)	Speed (m/s)	Latitude	Longitude
10/4/2008	358	1:18:21	2170	145	742	230	9.4	32.5468	-80.2842
10/4/2008	359	1:18:22	2638	296	902	226	13.4	32.5733	-80.3226
10/4/2008	360	1:18:20	6256	302	2140	186	12.8	32.5929	-80.3537
10/4/2008	361	1:18:21	1246	148	426	257	6.2	32.5533	-80.2904
10/4/2008	368	1:18:21	3167	170	1083	263	9.3	32.5348	-80.2913
10/4/2008	371	1:18:20	1059	355	362	151	10.8	32.5724	-80.2984
10/4/2008	372	1:18:20	1014	352	347	209	7.2	32.5719	-80.2989
10/4/2008	374	1:18:21	614	107	210	37	6.7	32.5613	-80.2911
10/4/2008	377	1:18:21	2231	133	763	217	12.6	32.5491	-80.2800
10/4/2008	383	1:18:20	2261	60	774	226	8.3	32.5733	-80.2766
10/4/2008	385	1:18:22	1710	228	585	249	6.5	32.5527	-80.3109
10/4/2008	388	1:18:20	989	343	338	47	8.1	32.5714	-80.3005
10/4/2008	392	1:18:21	2348	113	803	199	11.3	32.5545	-80.2744
10/4/2008	396	1:18:21	1285	125	440	37	12.1	32.5562	-80.2862
10/4/2008	405	1:18:21	690	183	236	77	10.4	32.5567	-80.2977
10/4/2008	409	1:18:20	482	342	165	340	4.8	32.5670	-80.2989
10/4/2008	411	1:18:21	2955	142	1011	221	11.4	32.5418	-80.2781
10/4/2008	414	1:18:20	1395	352	477	323	7.0	32.5754	-80.2993
10/4/2008	416	1:18:21	5109	101	1747	169	13.5	32.5539	-80.2440
10/4/2008	418	1:18:21	2095	107	716	238	8.6	32.5575	-80.2760
10/4/2008	420	1:18:21	1354	119	463	262	1.4	32.5569	-80.2848
10/4/2008	422	1:18:21	3340	177	1142	252	10.0	32.5328	-80.2956
10/4/2008	424	1:18:21	768	135	263	252	5.6	32.5580	-80.2916
10/4/2008	433	1:18:21	972	131	333	22	8.6	32.5571	-80.2896
10/4/2008	436	1:18:21	2677	143	916	204	12.9	32.5437	-80.2800
10/4/2008	438	1:18:21	1144	182	391	301	13.2	32.5526	-80.2977
10/4/2008	439	1:18:21	1714	153	586	283	4.0	32.5492	-80.2890
10/4/2008	441	1:18:21	3170	185	1084	220	10.2	32.5344	-80.3003
10/4/2008	446	1:18:22	2068	206	707	307	9.6	32.5461	-80.3068
10/4/2008	447	1:18:21	1271	195	435	65	10.2	32.5518	-80.3009
10/4/2008	453	1:18:22	623	227	213	18	15.5	32.5591	-80.3022
10/4/2008	454	1:18:22	766	225	262	267	7.4	32.5580	-80.3031
10/4/2008	458	1:18:22	1958	308	670	239	8.3	32.5737	-80.3138
10/4/2008	460	1:18:22	3702	218	1266	259	7.9	32.5364	-80.3213
10/4/2008	461	1:18:20	1173	338	401	311	6.2	32.5727	-80.3020
10/4/2008	471	1:18:21	2180	78	746	193	5.6	32.5671	-80.2747
10/4/2008	481	1:18:22	3728	319	1275	198	13.8	32.5883	-80.3233

Table D-1 (cont.).

Date	Track ID	Update Time	Range (m)	Azimuth (deg.)	Height (m)	Heading (deg.)	Speed (m/s)	Latitude	Longitude
10/4/2008	487	1:18:22	1514	310	518	236	8.4	32.5716	-80.3097
10/4/2008	488	1:18:20	1517	4	519	33	10.6	32.5765	-80.2961
10/4/2008	489	1:18:20	1138	351	389	278	17.7	32.5730	-80.2992
10/4/2008	490	1:18:21	2410	119	824	210	10.5	32.5525	-80.2748
10/4/2008	491	1:18:20	1341	27	459	272	6.1	32.5737	-80.2909
10/4/2008	492	1:18:22	2705	322	925	239	12.3	32.5821	-80.3152
10/4/2008	496	1:18:20	3305	342	1130	221	9.6	32.5913	-80.3080
10/4/2008	499	1:18:20	1529	47	523	308	17.6	32.5724	-80.2855
10/4/2008	501	1:18:21	3574	157	1222	239	11.5	32.5333	-80.2822
10/4/2008	502	1:18:20	3027	68	1035	257	38.4	32.5732	-80.2675
10/4/2008	506	1:18:21	1135	80	388	245	5.6	32.5647	-80.2854
10/4/2008	510	1:18:21	3093	114	1058	196	13.0	32.5517	-80.2672
10/4/2008	519	1:18:20	1023	328	350	59	2.6	32.5707	-80.3031
10/4/2008	522	1:18:22	1630	320	558	274	5.5	32.5742	-80.3084
10/4/2008	524	1:18:21	3386	82	1158	199	13.5	32.5672	-80.2616
10/4/2008	525	1:18:20	879	357	301	28	5.9	32.5708	-80.2978
10/4/2008	526	1:18:22	2371	327	811	239	12.0	32.5809	-80.3110
10/4/2008	527	1:18:22	370	321	126	18	5.3	32.5655	-80.2998
10/4/2008	533	1:18:22	1003	228	343	125	8.3	32.5569	-80.3053
10/4/2008	537	1:18:21	2012	145	688	204	6.4	32.5480	-80.2851
10/4/2008	538	1:18:21	804	95	275	319	8.4	32.5622	-80.2888
10/4/2008	542	1:18:21	3928	85	1343	200	12.7	32.5662	-80.2557
10/4/2008	547	1:18:21	1029	126	352	56	10.0	32.5574	-80.2885
10/4/2008	551	1:18:21	2824	168	966	243	12.2	32.5380	-80.2911
10/4/2008	552	1:18:21	4795	163	1640	141	6.7	32.5216	-80.2822
10/4/2008	554	1:18:21	1090	168	373	46	7.8	32.5533	-80.2948
10/4/2008	556	1:18:21	912	78	312	37	5.7	32.5646	-80.2878
10/4/2008	559	1:18:21	2701	187	924	220	9.1	32.5387	-80.3010
10/4/2008	561	1:18:21	1084	183	371	70	9.9	32.5531	-80.2978
10/4/2008	565	1:18:21	1870	105	640	144	5.4	32.5586	-80.2781
10/4/2008	566	1:18:21	3175	198	1086	158	13.1	32.5356	-80.3077
10/4/2008	567	1:18:22	1349	223	461	289	10.2	32.5540	-80.3071
10/4/2008	570	1:18:22	1121	225	384	19	3.9	32.5558	-80.3058
10/4/2008	573	1:18:22	2166	321	741	245	11.8	32.5781	-80.3118
10/4/2008	576	1:18:20	1243	68	425	22	5.1	32.5671	-80.2851
10/4/2008	578	1:18:21	3353	120	1147	204	11.8	32.5480	-80.2663
10/4/2008	579	1:18:22	1639	268	561	21	6.8	32.5623	-80.3148

Table D-1 (cont.).

Date	Track ID	Update Time	Range (m)	Azimuth (deg.)	Height (m)	Heading (deg.)	Speed (m/s)	Latitude	Longitude
10/4/2008	586	1:18:22	1097	309	375	27	9.4	32.5691	-80.3064
10/4/2008	590	1:18:22	4439	321	1518	190	10.9	32.5938	-80.3273
10/4/2008	597	1:18:20	2769	351	947	219	17.9	32.5875	-80.3022
10/4/2008	598	1:18:20	3243	352	1109	238	9.7	32.5919	-80.3020
10/4/2008	600	1:18:20	2003	356	685	212	7.4	32.5809	-80.2989
10/4/2008	603	1:18:22	3035	324	1038	210	13.6	32.5850	-80.3163
10/4/2008	606	1:18:21	1900	183	650	224	5.0	32.5458	-80.2984
10/4/2008	609	1:18:22	4318	294	1477	176	14.9	32.5787	-80.3394
10/4/2008	610	1:18:21	1359	115	465	28	21.0	32.5576	-80.2843
10/4/2008	611	1:18:20	1320	56	452	259	6.2	32.5696	-80.2857
10/4/2008	613	1:18:20	1233	66	422	80	6.5	32.5673	-80.2853
10/4/2008	616	1:18:21	3815	85	1305	204	9.0	32.5662	-80.2569
10/4/2008	619	1:18:22	2246	321	768	235	12.4	32.5786	-80.3124
10/4/2008	620	1:18:21	1385	79	474	316	4.1	32.5652	-80.2828
10/4/2008	622	1:18:22	732	252	250	195	36.8	32.5608	-80.3047
10/4/2008	626	1:18:20	5189	352	1775	200	10.3	32.6092	-80.3052
10/4/2008	627	1:18:21	1038	185	355	67	8.4	32.5536	-80.2983
10/4/2008	628	1:18:22	764	221	261	320	14.9	32.5577	-80.3027
10/4/2008	630	1:18:22	605	236	207	2	17.3	32.5598	-80.3027
10/4/2008	633	1:18:21	981	79	335	39	14.1	32.5646	-80.2871
10/4/2008	634	1:18:20	1378	7	471	255	7.4	32.5752	-80.2955
10/4/2008	635	1:18:21	2721	110	931	204	14.1	32.5547	-80.2700
10/4/2008	640	1:18:21	3344	162	1144	193	10.1	32.5342	-80.2863
10/4/2008	641	1:18:21	1365	163	467	1	9.0	32.5511	-80.2931
10/4/2008	642	1:18:21	1055	162	361	35	8.4	32.5539	-80.2938
10/4/2008	643	1:18:20	2526	56	864	223	10.3	32.5757	-80.2751
10/4/2008	644	1:18:21	1780	189	609	314	3.7	32.5470	-80.3003
10/4/2008	645	1:18:21	3549	191	1214	197	3.3	32.5315	-80.3047
10/4/2008	646	1:18:22	610	202	209	4	25.6	32.5578	-80.2998
10/4/2008	648	1:18:22	1891	333	647	289	5.8	32.5780	-80.3066
10/4/2008	652	1:18:21	3251	121	1112	216	11.8	32.5479	-80.2676
10/4/2008	653	1:18:22	2729	221	933	221	7.2	32.5443	-80.3163
10/4/2008	654	1:18:21	2593	100	887	121	13.4	32.5588	-80.2702
10/4/2008	654	1:18:22	3303	218	1130	177	14.1	32.5394	-80.3190
10/4/2008	659	1:18:22	2720	238	930	246	11.3	32.5498	-80.3218
10/4/2008	662	1:18:22	1575	263	539	246	30.3	32.5612	-80.3140
10/4/2008	663	1:18:21	5153	113	1763	182	16.4	32.5447	-80.2469

Table D-1 (cont.).

Date	Track ID	Update Time	Range (m)	Azimuth (deg.)	Height (m)	Heading (deg.)	Speed (m/s)	Latitude	Longitude
10/4/2008	666	1:18:22	1025	290	351	55	13.8	32.5660	-80.3076
10/4/2008	668	1:18:21	2976	132	1018	229	9.7	32.5449	-80.2739
10/4/2008	669	1:18:22	4156	301	1422	185	10.0	32.5819	-80.3355
10/4/2008	674	1:18:21	1112	88	380	6	13.2	32.5633	-80.2855
10/4/2008	676	1:18:22	3722	330	1273	222	14.0	32.5919	-80.3173
10/4/2008	685	1:18:21	1081	177	370	59	10.0	32.5532	-80.2967
10/4/2008	688	1:18:22	2335	314	799	236	10.2	32.5775	-80.3153
10/4/2008	695	1:18:20	1472	64	503	354	9.1	32.5687	-80.2832
10/4/2008	703	1:18:22	576	331	197	53	9.9	32.5675	-80.3003
10/4/2008	706	1:18:22	826	328	283	29	6.0	32.5692	-80.3020
10/4/2008	712	1:18:22	1718	319	588	276	5.9	32.5746	-80.3093
10/4/2008	713	1:18:22	2986	328	1021	221	14.0	32.5858	-80.3140
10/4/2008	714	1:18:22	3835	332	1312	216	9.5	32.5935	-80.3163
10/4/2008	715	1:18:20	3217	339	1100	182	10.6	32.5900	-80.3094
10/4/2008	721	1:18:20	1189	347	407	247	11.1	32.5733	-80.3002
10/4/2008	723	1:18:20	1195	9	409	330	6.5	32.5736	-80.2954
10/4/2008	732	1:18:20	4144	63	1418	152	19.2	32.5796	-80.2579
10/4/2008	734	1:18:20	1280	51	438	320	4.1	32.5701	-80.2867

D.2 Listing of One-Hour Track History Files From the WIAR1 and eBirdRad Radars at NASWI.

Table D-2 lists the names of the 168 1-hour track history files that we used as evidence of the 24/7 continuous data recording of two radars at NASWI: The CEAT AR1 radar (WIAR1) with an array antenna, and the Navy’s eBirdRad radar (WIEBirdRad) with a dish antenna. Refer to Section 6.2.1.1 for the description, analysis, and results of the PB1.1 Performance Criterion.

Table D-2. Track history file names used to document continuous data recording from two radars, WIAR1 and WIEBirdRad, at NASWI for a one-week period between 12-18 March 2008.

Date/Time (PST)	Track History File Name	
	WIAR1 Radar	WIEBirdRad Radar
03/12/2008		
00:00-01:00	WI_AR1_20080312_0000-0100.jpg	WI_eBird_20080312_0000-0100.jpg
01:00-02:00	WI_AR1_20080312_0100-0200.jpg	WI_eBird_20080312_0100-0200.jpg
02:00-03:00	WI_AR1_20080312_0200-0300.jpg	WI_eBird_20080312_0200-0300.jpg
03:00-04:00	WI_AR1_20080312_0300-0400.jpg	WI_eBird_20080312_0300-0400.jpg
04:00-05:00	WI_AR1_20080312_0400-0500.jpg	WI_eBird_20080312_0400-0500.jpg
05:00-06:00	WI_AR1_20080312_0500-0600.jpg	WI_eBird_20080312_0500-0600.jpg
06:00-07:00	WI_AR1_20080312_0600-0700.jpg	WI_eBird_20080312_0600-0700.jpg
07:00-08:00	WI_AR1_20080312_0700-0800.jpg	WI_eBird_20080312_0700-0800.jpg
08:00-09:00	WI_AR1_20080312_0800-0900.jpg	WI_eBird_20080312_0800-0900.jpg
09:00-10:00	WI_AR1_20080312_0900-1000.jpg	WI_eBird_20080312_0900-1000.jpg
10:00-11:00	WI_AR1_20080312_1000-1100.jpg	WI_eBird_20080312_1000-1100.jpg
11:00-12:00	WI_AR1_20080312_1100-1200.jpg	WI_eBird_20080312_1100-1200.jpg
12:00-13:00	WI_AR1_20080312_1200-1300.jpg	WI_eBird_20080312_1200-1300.jpg
13:00-14:00	WI_AR1_20080312_1300-1400.jpg	WI_eBird_20080312_1300-1400.jpg
14:00-15:00	WI_AR1_20080312_1400-1500.jpg	WI_eBird_20080312_1400-1500.jpg
15:00-16:00	WI_AR1_20080312_1500-1600.jpg	WI_eBird_20080312_1500-1600.jpg
16:00-17:00	WI_AR1_20080312_1600-1700.jpg	WI_eBird_20080312_1600-1700.jpg
17:00-18:00	WI_AR1_20080312_1700-1800.jpg	WI_eBird_20080312_1700-1800.jpg
18:00-19:00	WI_AR1_20080312_1800-1900.jpg	WI_eBird_20080312_1800-1900.jpg
19:00-20:00	WI_AR1_20080312_1900-2000.jpg	WI_eBird_20080312_1900-2000.jpg
20:00-21:00	WI_AR1_20080312_2000-2100.jpg	WI_eBird_20080312_2000-2100.jpg
21:00-22:00	WI_AR1_20080312_2100-2200.jpg	WI_eBird_20080312_2100-2200.jpg
22:00-23:00	WI_AR1_20080312_2200-2300.jpg	WI_eBird_20080312_2200-2300.jpg
23:00-24:00	WI_AR1_20080312_2300-2400.jpg	WI_eBird_20080312_2300-2400.jpg
03/13/2008		
00:00-01:00	WI_AR1_20080313_0000-0100.jpg	WI_eBird_20080313_0000-0100.jpg
01:00-02:00	WI_AR1_20080313_0100-0200.jpg	WI_eBird_20080313_0100-0200.jpg
02:00-03:00	WI_AR1_20080313_0200-0300.jpg	WI_eBird_20080313_0200-0300.jpg
03:00-04:00	WI_AR1_20080313_0300-0400.jpg	WI_eBird_20080313_0300-0400.jpg
04:00-05:00	WI_AR1_20080313_0400-0500.jpg	WI_eBird_20080313_0400-0500.jpg
05:00-06:00	WI_AR1_20080313_0500-0600.jpg	WI_eBird_20080313_0500-0600.jpg
06:00-07:00	WI_AR1_20080313_0600-0700.jpg	WI_eBird_20080313_0600-0700.jpg
07:00-08:00	WI_AR1_20080313_0700-0800.jpg	WI_eBird_20080313_0700-0800.jpg
08:00-09:00	WI_AR1_20080313_0800-0900.jpg	WI_eBird_20080313_0800-0900.jpg

Table D-2 (cont.).

09:00-10:00	WI_AR1_20080313_0900-1000.jpg	WI_eBird_20080313_0900-1000.jpg
10:00-11:00	WI_AR1_20080313_1000-1100.jpg	WI_eBird_20080313_1000-1100.jpg
11:00-12:00	WI_AR1_20080313_1100-1200.jpg	WI_eBird_20080313_1100-1200.jpg
12:00-13:00	WI_AR1_20080313_1200-1300.jpg	WI_eBird_20080313_1200-1300.jpg
13:00-14:00	WI_AR1_20080313_1300-1400.jpg	WI_eBird_20080313_1300-1400.jpg
14:00-15:00	WI_AR1_20080313_1400-1500.jpg	WI_eBird_20080313_1400-1500.jpg
15:00-16:00	WI_AR1_20080313_1500-1600.jpg	WI_eBird_20080313_1500-1600.jpg
16:00-17:00	WI_AR1_20080313_1600-1700.jpg	WI_eBird_20080313_1600-1700.jpg
17:00-18:00	WI_AR1_20080313_1700-1800.jpg	WI_eBird_20080313_1700-1800.jpg
18:00-19:00	WI_AR1_20080313_1800-1900.jpg	WI_eBird_20080313_1800-1900.jpg
19:00-20:00	WI_AR1_20080313_1900-2000.jpg	WI_eBird_20080313_1900-2000.jpg
20:00-21:00	WI_AR1_20080313_2000-2100.jpg	WI_eBird_20080313_2000-2100.jpg
21:00-22:00	WI_AR1_20080313_2100-2200.jpg	WI_eBird_20080313_2100-2200.jpg
22:00-23:00	WI_AR1_20080313_2200-2300.jpg	WI_eBird_20080313_2200-2300.jpg
23:00-24:00	WI_AR1_20080313_2300-2400.jpg	WI_eBird_20080313_2300-2400.jpg
03/14/2008		
00:00-01:00	WI_AR1_20080314_0000-0100.jpg	WI_eBird_20080314_0000-0100.jpg
01:00-02:00	WI_AR1_20080314_0100-0200.jpg	WI_eBird_20080314_0100-0200.jpg
02:00-03:00	WI_AR1_20080314_0200-0300.jpg	WI_eBird_20080314_0200-0300.jpg
03:00-04:00	WI_AR1_20080314_0300-0400.jpg	WI_eBird_20080314_0300-0400.jpg
04:00-05:00	WI_AR1_20080314_0400-0500.jpg	WI_eBird_20080314_0400-0500.jpg
05:00-06:00	WI_AR1_20080314_0500-0600.jpg	WI_eBird_20080314_0500-0600.jpg
06:00-07:00	WI_AR1_20080314_0600-0700.jpg	WI_eBird_20080314_0600-0700.jpg
07:00-08:00	WI_AR1_20080314_0700-0800.jpg	WI_eBird_20080314_0700-0800.jpg
08:00-09:00	WI_AR1_20080314_0800-0900.jpg	WI_eBird_20080314_0800-0900.jpg
09:00-10:00	WI_AR1_20080314_0900-1000.jpg	WI_eBird_20080314_0900-1000.jpg
10:00-11:00	WI_AR1_20080314_1000-1100.jpg	WI_eBird_20080314_1000-1100.jpg
11:00-12:00	WI_AR1_20080314_1100-1200.jpg	WI_eBird_20080314_1100-1200.jpg
12:00-13:00	WI_AR1_20080314_1200-1300.jpg	WI_eBird_20080314_1200-1300.jpg
13:00-14:00	WI_AR1_20080314_1300-1400.jpg	WI_eBird_20080314_1300-1400.jpg
14:00-15:00	WI_AR1_20080314_1400-1500.jpg	WI_eBird_20080314_1400-1500.jpg
15:00-16:00	WI_AR1_20080314_1500-1600.jpg	WI_eBird_20080314_1500-1600.jpg
16:00-17:00	WI_AR1_20080314_1600-1700.jpg	WI_eBird_20080314_1600-1700.jpg
17:00-18:00	WI_AR1_20080314_1700-1800.jpg	WI_eBird_20080314_1700-1800.jpg
18:00-19:00	WI_AR1_20080314_1800-1900.jpg	WI_eBird_20080314_1800-1900.jpg
19:00-20:00	WI_AR1_20080314_1900-2000.jpg	WI_eBird_20080314_1900-2000.jpg
20:00-21:00	WI_AR1_20080314_2000-2100.jpg	WI_eBird_20080314_2000-2100.jpg
21:00-22:00	WI_AR1_20080314_2100-2200.jpg	WI_eBird_20080314_2100-2200.jpg
22:00-23:00	WI_AR1_20080314_2200-2300.jpg	WI_eBird_20080314_2200-2300.jpg
23:00-24:00	WI_AR1_20080314_2300-2400.jpg	WI_eBird_20080314_2300-2400.jpg
03/15/2008		
00:00-01:00	WI_AR1_20080315_0000-0100.jpg	WI_eBird_20080316_0000-0100.jpg
01:00-02:00	WI_AR1_20080315_0100-0200.jpg	WI_eBird_20080315_0100-0200.jpg
02:00-03:00	WI_AR1_20080314_0200-0300.jpg	WI_eBird_20080315_0200-0300.jpg
03:00-04:00	WI_AR1_20080314_0300-0400.jpg	WI_eBird_20080315_0300-0400.jpg
04:00-05:00	WI_AR1_20080314_0400-0500.jpg	WI_eBird_20080315_0400-0500.jpg
05:00-06:00	WI_AR1_20080315_0500-0600.jpg	WI_eBird_20080315_0500-0600.jpg
06:00-07:00	WI_AR1_20080315_0600-0700.jpg	WI_eBird_20080315_0600-0700.jpg

Table D-2 (cont.).

07:00-08:00	WI_AR1_20080315_0700-0800.jpg	WI_eBird_20080315_0700-0800.jpg
08:00-09:00	WI_AR1_20080315_0800-0900.jpg	WI_eBird_20080315_0800-0900.jpg
09:00-10:00	WI_AR1_20080315_0900-1000.jpg	WI_eBird_20080315_0900-1000.jpg
10:00-11:00	WI_AR1_20080315_1000-1100.jpg	WI_eBird_20080315_1000-1100.jpg
11:00-12:00	WI_AR1_20080315_1100-1200.jpg	WI_eBird_20080315_1100-1200.jpg
12:00-13:00	WI_AR1_20080315_1200-1300.jpg	WI_eBird_20080315_1200-1300.jpg
13:00-14:00	WI_AR1_20080315_1300-1400.jpg	WI_eBird_20080315_1300-1400.jpg
14:00-15:00	WI_AR1_20080315_1400-1500.jpg	WI_eBird_20080315_1400-1500.jpg
15:00-16:00	WI_AR1_20080315_1500-1600.jpg	WI_eBird_20080315_1500-1600.jpg
16:00-17:00	WI_AR1_20080315_1600-1700.jpg	WI_eBird_20080315_1600-1700.jpg
17:00-18:00	WI_AR1_20080315_1700-1800.jpg	WI_eBird_20080315_1700-1800.jpg
18:00-19:00	WI_AR1_20080315_1800-1900.jpg	WI_eBird_20080315_1800-1900.jpg
19:00-20:00	WI_AR1_20080315_1900-2000.jpg	WI_eBird_20080315_1900-2000.jpg
20:00-21:00	WI_AR1_20080315_2000-2100.jpg	WI_eBird_20080315_2000-2100.jpg
21:00-22:00	WI_AR1_20080315_2100-2200.jpg	WI_eBird_20080315_2100-2200.jpg
22:00-23:00	WI_AR1_20080315_2200-2300.jpg	WI_eBird_20080315_2200-2300.jpg
23:00-24:00	WI_AR1_20080315_2300-2400.jpg	WI_eBird_20080315_2300-2400.jpg
03/16/2008		
00:00-01:00	WI_AR1_20080316_0000-0100.jpg	WI_eBird_20080316_0000-0100.jpg
01:00-02:00	WI_AR1_20080316_0100-0200.jpg	WI_eBird_20080316_0100-0200.jpg
02:00-03:00	WI_AR1_20080316_0200-0300.jpg	WI_eBird_20080316_0200-0300.jpg
03:00-04:00	WI_AR1_20080316_0300-0400.jpg	WI_eBird_20080316_0300-0400.jpg
04:00-05:00	WI_AR1_20080316_0400-0500.jpg	WI_eBird_20080316_0400-0500.jpg
05:00-06:00	WI_AR1_20080316_0500-0600.jpg	WI_eBird_20080317_0500-0600.jpg
06:00-07:00	WI_AR1_20080316_0600-0700.jpg	WI_eBird_20080316_0600-0700.jpg
07:00-08:00	WI_AR1_20080316_0700-0800.jpg	WI_eBird_20080316_0700-0800.jpg
08:00-09:00	WI_AR1_20080316_0800-0900.jpg	WI_eBird_20080316_0800-0900.jpg
09:00-10:00	WI_AR1_20080316_0900-1000.jpg	WI_eBird_20080316_0900-1000.jpg
10:00-11:00	WI_AR1_20080316_1000-1100.jpg	WI_eBird_20080316_1000-1100.jpg
11:00-12:00	WI_AR1_20080316_1100-1200.jpg	WI_eBird_20080316_1100-1200.jpg
12:00-13:00	WI_AR1_20080316_1200-1300.jpg	WI_eBird_20080316_1200-1300.jpg
13:00-14:00	WI_AR1_20080316_1300-1400.jpg	WI_eBird_20080316_1300-1400.jpg
14:00-15:00	WI_AR1_20080316_1400-1500.jpg	WI_eBird_20080316_1400-1500.jpg
15:00-16:00	WI_AR1_20080316_1500-1600.jpg	WI_eBird_20080316_1500-1600.jpg
16:00-17:00	WI_AR1_20080316_1600-1700.jpg	WI_eBird_20080316_1600-1700.jpg
17:00-18:00	WI_AR1_20080316_1700-1800.jpg	WI_eBird_20080316_1700-1800.jpg
18:00-19:00	WI_AR1_20080316_1800-1900.jpg	WI_eBird_20080316_1800-1900.jpg
19:00-20:00	WI_AR1_20080316_1900-2000.jpg	WI_eBird_20080316_1900-2000.jpg
20:00-21:00	WI_AR1_20080316_2000-2100.jpg	WI_eBird_20080316_2000-2100.jpg
21:00-22:00	WI_AR1_20080316_2100-2200.jpg	WI_eBird_20080316_2100-2200.jpg
22:00-23:00	WI_AR1_20080316_2200-2300.jpg	WI_eBird_20080316_2200-2300.jpg
23:00-24:00	WI_AR1_20080316_2300-2400.jpg	WI_eBird_20080316_2300-2400.jpg
03/17/2008		
00:00-01:00	WI_AR1_20080317_0000-0100.jpg	WI_eBird_20080317_0000-0100.jpg
01:00-02:00	WI_AR1_20080317_0100-0200.jpg	WI_eBird_20080317_0100-0200.jpg
02:00-03:00	WI_AR1_20080317_0200-0300.jpg	WI_eBird_20080317_0200-0300.jpg
03:00-04:00	WI_AR1_20080317_0300-0400.jpg	WI_eBird_20080317_0300-0400.jpg
04:00-05:00	WI_AR1_20080317_0400-0500.jpg	WI_eBird_20080317_0400-0500.jpg

Table D-2 (cont.).

05:00-06:00	WI_AR1_20080317_0500-0600.jpg	WI_eBird_20080317_0500-0600.jpg
06:00-07:00	WI_AR1_20080317_0600-0700.jpg	WI_eBird_20080317_0600-0700.jpg
07:00-08:00	WI_AR1_20080317_0700-0800.jpg	WI_eBird_20080317_0700-0800.jpg
08:00-09:00	WI_AR1_20080317_0800-0900.jpg	WI_eBird_20080317_0800-0900.jpg
09:00-10:00	WI_AR1_20080317_0900-1000.jpg	WI_eBird_20080317_0900-1000.jpg
10:00-11:00	WI_AR1_20080317_1000-1100.jpg	WI_eBird_20080317_1000-1100.jpg
11:00-12:00	WI_AR1_20080317_1100-1200.jpg	WI_eBird_20080317_1100-1200.jpg
12:00-13:00	WI_AR1_20080317_1200-1300.jpg	WI_eBird_20080317_1200-1300.jpg
13:00-14:00	WI_AR1_20080317_1300-1400.jpg	WI_eBird_20080317_1300-1400.jpg
14:00-15:00	WI_AR1_20080317_1400-1500.jpg	WI_eBird_20080317_1400-1500.jpg
15:00-16:00	WI_AR1_20080317_1500-1600.jpg	WI_eBird_20080317_1500-1600.jpg
16:00-17:00	WI_AR1_20080317_1600-1700.jpg	WI_eBird_20080317_1600-1700.jpg
17:00-18:00	WI_AR1_20080317_1700-1800.jpg	WI_eBird_20080317_1700-1800.jpg
18:00-19:00	WI_AR1_20080317_1800-1900.jpg	WI_eBird_20080317_1800-1900.jpg
19:00-20:00	WI_AR1_20080317_1900-2000.jpg	WI_eBird_20080317_1900-2000.jpg
20:00-21:00	WI_AR1_20080317_2000-2100.jpg	WI_eBird_20080317_2000-2100.jpg
21:00-22:00	WI_AR1_20080317_2100-2200.jpg	WI_eBird_20080317_2100-2200.jpg
22:00-23:00	WI_AR1_20080317_2200-2300.jpg	WI_eBird_20080317_2200-2300.jpg
23:00-24:00	WI_AR1_20080317_2300-2400.jpg	WI_eBird_20080317_2300-2400.jpg
03/18/2008		
00:00-01:00	WI_AR1_20080318_0000-0100.jpg	WI_eBird_20080318_0000-0100.jpg
01:00-02:00	WI_AR1_20080318_0100-0200.jpg	WI_eBird_20080318_0100-0200.jpg
02:00-03:00	WI_AR1_20080318_0200-0300.jpg	WI_eBird_20080318_0200-0300.jpg
03:00-04:00	WI_AR1_20080318_0300-0400.jpg	WI_eBird_20080318_0300-0400.jpg
04:00-05:00	WI_AR1_20080318_0400-0500.jpg	WI_eBird_20080318_0400-0500.jpg
05:00-06:00	WI_AR1_20080318_0500-0600.jpg	WI_eBird_20080318_0500-0600.jpg
06:00-07:00	WI_AR1_20080318_0600-0700.jpg	WI_eBird_20080318_0600-0700.jpg
07:00-08:00	WI_AR1_20080318_0700-0800.jpg	WI_eBird_20080318_0700-0800.jpg
08:00-09:00	WI_AR1_20080318_0800-0900.jpg	WI_eBird_20080318_0800-0900.jpg
09:00-10:00	WI_AR1_20080318_0900-1000.jpg	WI_eBird_20080318_0900-1000.jpg
10:00-11:00	WI_AR1_20080318_1000-1100.jpg	WI_eBird_20080318_1000-1100.jpg
11:00-12:00	WI_AR1_20080318_1100-1200.jpg	WI_eBird_20080318_1100-1200.jpg
12:00-13:00	WI_AR1_20080318_1200-1300.jpg	WI_eBird_20080318_1200-1300.jpg
13:00-14:00	WI_AR1_20080318_1300-1400.jpg	WI_eBird_20080318_1300-1400.jpg
14:00-15:00	WI_AR1_20080318_1400-1500.jpg	WI_eBird_20080318_1400-1500.jpg
15:00-16:00	WI_AR1_20080318_1500-1600.jpg	WI_eBird_20080318_1500-1600.jpg
16:00-17:00	WI_AR1_20080318_1600-1700.jpg	WI_eBird_20080318_1600-1700.jpg
17:00-18:00	WI_AR1_20080318_1700-1800.jpg	WI_eBird_20080318_1700-1800.jpg
18:00-19:00	WI_AR1_20080318_1800-1900.jpg	WI_eBird_20080318_1800-1900.jpg
19:00-20:00	WI_AR1_20080318_1900-2000.jpg	WI_eBird_20080318_1900-2000.jpg
20:00-21:00	WI_AR1_20080318_2000-2100.jpg	WI_eBird_20080318_2000-2100.jpg
21:00-22:00	WI_AR1_20080318_2100-2200.jpg	WI_eBird_20080318_2100-2200.jpg
22:00-23:00	WI_AR1_20080318_2200-2300.jpg	WI_eBird_20080318_2200-2300.jpg
23:00-24:00	WI_AR1_20080318_2300-2400.jpg	WI_eBird_20080318_2300-2400.jpg

APPENDIX E. SURVEY OF AIRPORT PERSONNEL USE OF REMOTE DISPLAYS OF AVIAN RADAR INFORMATION

Airport:

Seattle-Tacoma International Airport (SEA)

Operator of remote display:

Steve Osmek, Senior Wildlife Biologist, Port of Seattle

Patrick Viehoever, Wildlife Biologist, USDA Wildlife Services

Date:

December 18, 2009

Technology Description

1. Provide a brief description of the technology used for remote display of avian radar information.

In cooperation with University of Illinois Center of Excellence for Airport Technology, the Port of Seattle (Port) has deployed three Accipiter radars at the Seattle Tacoma International Airport (SEA). The AR2, comprised of two separate radars, are operating at the southeast end of the airfield from the roof top of the Airport Office Building (AOB). The AR2 is optimized to detect and track bird activity at higher elevations (> 120 m) and at out to greater distances (> 7.4 km) than the AR1. The AR1, a ground-based deployment, is positioned midway along and between the Tango taxiway and Runway 34/16R (Figure 1). We selected the AR1 for this survey because this system employs an array style antenna that provides the best coverage of the lower elevations of the airfield where our observations are typically focused for wildlife hazard detection and abatement activities. Near the airfield, the AR1 display had relatively less interfering reflective clutter caused by large buildings and tall vegetation compared to the AR2 that used parabolic dish (pencil beam) antennas. AR1 wireless connectivity to the Port's internal computer network was achieved by transmitting data between the AR1 midfield trailer and a receiving antenna mounted on the roof of the AOB (near the AR2).

Remote radar access from our airport operations vehicle was provided using: (1) a center-console mounted laptop computer as shown in Figure 2, (2) an external wireless USB cell phone card, (3) Virtual Private Network (VPN) software to gain access to the Port's computer network, and (4) Virtual Network Computing (VNC) viewing software to remote in to the host computer that supported the AR1. The two types of display software were the Accipiter Digital Radar Processor (DRP) and the Google Earth Client (GEC).

Although Accipiter intended the DRP software to be used primarily by the radar engineer responsible for system monitoring and optimization, we found this software best suited our needs because both plots and tracks were displayed and updated more frequently. The advantage of the DRP software is it continually displays both plots (probable targets) and tracks (confirmed targets) simultaneously. The use of the GEC software had the advantage of integrating all track data from all three radars into one display plus a mode to quickly playback the preceding hour of activity for viewing. The GEC display used

DRP source data from all three radars. Our interest in plots was its ability to first detect tightly circling raptors, an activity pattern not always discernable with the tracking algorithms that had a tendency to produce more reliable tracks when targets moved in a more predictable less circuitous flight pattern

Technology Implementation

2. Provide a brief summary of how this technology was implemented at your airport?

Avian radar systems were installed and implemented at SEA to provide what we believed was a reasonable level of observational coverage for detecting most bird activity on and near SEA. Port and the USDA wildlife biologists critically evaluated this technology to gain a better understanding of how avian radars might affect our real-time situational awareness of airport wildlife hazards and our ability to respond to them more rapidly than we normally could without radar to provide us with bird movement information.

Although two observers in one vehicle was atypical for normal operations on the airfield, this was done to better explore the range of technological benefits the radars might provide and to maintain a high level of safety while driving on the airfield.

From 15-17 June a total of 10 hours, during 7 sessions, were expended actively watching the remote DRP display. Evaluations of the Accipiter AR1 radar were made predominantly using three methods:

Early Notification – As near real-time “bird” tracks were viewed remotely on the DRP display, we drove to the geographic location of those detections to determine if birds were still present. If present, we determined if the bird activity was sufficiently hazardous for control actions to be taken. The automated sense and alert capabilities of the DRP software and Accipiter’s Track Viewer software are currently undergoing further evaluation and were not part of this survey.

Observational Confirmation – After areas of high bird use were visually ascertained we drove the vehicle to that location and parked. Additional visual observations of birds were compared with the real-time plots and tracks information for comparison and potential confirmation.

Display Latency Determination – To better interpret the meaning of “real-time” radar information shown on the remote displays and understand its usefulness for airport utility, we conducted several trials to determine display latency. The DRP initially displays targets as plots (green unfilled circles). Once confirmed, these detections are displayed as tracks (red solid rectangles with a directional pointer). The DRP has the beneficial feature of displaying up to 120 of the previous tracks and plots, detections that slowly faded and darken with time. While the GEC is currently not designed to display plots or historic detections in the real-time display mode, it has the advantage of displaying tracks in three colors, one for each radar, and the ability to rapidly playback the tracks from the previous hour.

Multiple trials were conducted to measure and compare radar display latency values for both the DRP and GEC displays under two scenarios that might reflect typical bird behavior: (1) landing and takeoff activity and (2) “fly passing” behavior where the bird flies over the airfield in a more consistent direction and rate of speed. Our vehicle was

used as the real-time target because it was readily tracked on both displays. For the landing/taking off activity, elapsed time was measured to determine the lag expressed between when the vehicle quickly went from a stationary position to 10 m/s and again from that speed to stopping rapidly. The fly passing trail was conducted by measuring the time from when the vehicle traveling at 10 m/s actually passed a known point in the airfield compared the time the vehicle track was displayed in the same location on the remote DRP display.

3. *Provide a brief summary of the present level of technology integration with ongoing wildlife management programs at your airport.*

Since August 2007, daily access to the radar historic data and the live radar display at SEA has been limited to our use, a Port and a USDA wildlife biologist. The archived data has been used to successfully quantify starling behavior, identify roost locations, and to test for differences in bird use between new stormwater detention ponds and other locations already managed using approved airport wildlife hazard mitigation protocols. In December 2009, remote access to the avian radar display from our airport operation's vehicle became available via a laptop computer with a wireless connection. Other airport operation's personnel are aware of the radar's presence and purpose on the airfield but do not currently make use of the real-time radar displays in their daily duties.

4. *Provide a brief summary of your use of this technology in normal wildlife management activities.*

Until recently, the real-time avian radar track and plot information was not being used as part of the typical wildlife hazard management activities. To date the primary use of the avian radar at SEA has been the evaluation of archived data over for the purpose of identifying trends and making predictions about wildlife activity on the airfield both geographically and temporally.

Early Notification - We primarily utilized the DRP display for 8 of the 10 hours and experienced one instance out of 10 where we felt confident we were responding to the same birds first detected by the radar. Known complicating factors in the other 9 instances include the realization that small nonhazardous birds such as sparrows are also visible to the radar even though our search for wildlife hazards rarely included them unless their numbers were sufficiently large to be a potential aviation threat and worthy of an employing harassment measures. Additionally, there was no way of confirming whether the bird(s) detected by the radar, often a mile or more from our original position, were still present after we arrived. Further complicating this critique was the low number of hazardous bird events documented during our short evaluation period that occurred over three days.

Observational Confirmation – Much of the effort expended to complete this survey was from a parked or slowly moving vehicle with the USDA Biologist watching the radar display and assisting the Port Biologist (driver) look for hazardous wildlife species on and near the airfield. On at least two instances we confirmed the radar was tracking a flock of 300 to 400 starlings that we first observed visually. In several other situations, where we visually tracked less hazardous aggregations of birds such as several crows or a

few gulls, the radar did not provide us this information on the DRP display. Even if all three radar displays were being monitored simultaneously, it's extremely important to understand the premise under which we were conducting the survey: the ability of avian radars to detect and track birds is a function of where the bird is in relation to the energy of the radar beam at that time. Given the antennas have a fixed coverage volume, many of these birds may have been outside the zone of detection. We were not able to check either of the AR2 radars to determine if they were detecting the birds we were watching.

Utility of Technology in Airport Operations

5. *Please rate the following where 1=poor, 2=fair, 3=good, 4=very good, and 5= excellent.*

The assigned numerical ratings were for the DRP unless specified otherwise:

<i>Ease of Implementation</i>	4
<i>Ease of Use</i>	3
<i>Timeliness</i>	3
<i>General Utility</i>	3
<i>Demonstrated validity of display</i>	4
<i>Reliability</i>	4

Please provide specific comments to support or expand your rating.

Ease of Implementation - An important component of implementing a remote radar display was working with the Port's Informational Technology department to acquire permissions to install and use VPN and VNC software to remotely access the airports internal computer network and the AR1 host computer operating in the midfield trailer. Except for the USB wireless device becoming dysfunctional itself, once a connection was established there were no serious hardware or software issues the prevented us from maintaining communication to the AR1 remotely. Future laptops used for displaying targets remotely might consider the use of an internal rather than an external USB wireless device to better protect this hardware from damage when being used an environment where the PC may be moved frequently.

Ease of Use – Both the remote DRP and GEC displays were used and compared. While the GEC was specifically designed for a high level of user satisfaction, the purpose of the DRP software was for system monitoring and maintenance. Nonetheless, most of our time was spent using the DRP display because of its current capabilities of presenting the plots and tracks with up to 120 of the previous detections commingled in one display.

Timeliness – To determine display latency, multiple trails were conducted with both the remote DRP and the GEC displays (**Table E-1**). Results consistently indicated a more rapid update rate and response times for the DRP than the GEC that was tasked with first processing DRP data from all three radars before being displayed. For the fly passing trials, the latency from when the vehicle passed a given point on the airfield to when it actually passed the displayed point was equivalent to the update rate (screen refresh rate).

Table E-1. Remote radar display latency (seconds) by computer application. The same airport operation’s vehicle was used as a dynamic target for tracking and the observation platform equipped with a PC laptop, the hardware supporting the remote display. A connection to the Port of Seattle’s computer network was made using an external wireless USB device.

Application	Refresh Rate (s)	Display Latency (s)*
Google Earth Client (GEC)	5	17-22
Digital Radar Processor (DRP)	2.5	8-10

*Amount of time that passed before the display showed a new moving target as a track or dropped an existing track from that had ended. Vehicle (target) speed was ranged from stationary to 10 m/s, the low end of a typical birds flight speed.

Higher latency periods with both applications were noted to detect a target that had recently become active or inactive, such as birds taking off or for birds that had just landed, respectively, than for a vehicle’s position to be correctly determined as it passed a predetermined geographic point on the airfield at a constant rate of speed (10 m/s). The reason for this was evident when watching the DRP display. The plots would first appear in 3 to 5 seconds after becoming mobile and then the confirmed tracks would be displayed beginning several seconds later.

General Utility - The extent to which our wildlife control activities truly benefitted from the manual use of the real-time remote display rather than automated hazard alert system was a topic of discussion during these trials. Having an extra person in the vehicle using the remote display almost continually was an atypical situation but one that was vital in gaining a better understanding of the strengths and limitations of using this technology for conducting daily wildlife control activities.

Certainly, the greatest benefit from this technology to date was using the archived data to highlight bird activity in terms of temporal and geographic trends. For example, we are now able to quantify the changed in the number of targets are detected before and after sunrise and sundown. Fewer suspected bird targets were observed during darkness immediately preceding or following a period of daylight. This pattern of activity is confirmed by our knowledge of the airport environment where birds, especially starlings and American crows (crows) that reach peak numbers on and near the airport at dawn and dusk as they depart from and gather to their night roosts. Target number was not assessed during periods of total darkness because of human limitations to observe birds then.

Demonstrated Validity of Display – Both displays used the same radar data initially processed by the DRP software and provided credible information when understood that objects other than birds were also being readily tracked. Rather than having the DRP software mask out the runways and taxiway where human-related ground movement activity typically occurred, we instead cognitively parsed out this superfluous information and focus our attention in the other areas where we would only expect bird targets to be. An added advantage of watching a tracked vehicle is it gave geographic perspective to a highflying bird that was also being tracked.

Reliability – The ease of using the radar system during the 7 sessions could only be rated

very high as it has been operating without mishaps for many months. One user limitation is we were not able to determine the operational health of the radar systems. Alarms, for those times when the system is malfunctioning should be part of future upgrades similar to what the FAA now has with its NAVAIDS at SEA. CEAT is the process of developing protocols for periodic system checks and routine maintenance so the functional health of each radar can be evaluated before a system degrades to a point where there is a significant loss in the unit's ability to detect birds (weak magnetron).

Overall Rating of Remote Display

6. *Please rate the following where 1 = poor, 2=fair, 3=good, 4=very good and 5 = excellent.*

The assigned numerical ratings were for the DRP unless specified otherwise:

<i>Display information content</i>	4
<i>Display update rate</i>	3
<i>Display Format</i>	2

Please provide specific comments to support or expand your rating.

Display information content - Overall the DRP is very good for viewing the plots and tracks from a single radar at a time. We found plot information to be extremely valuable when displayed in conjunction with the track information for identifying birds circling tightly or in other ways that may not always be detected by the tracking algorithms. The GEC had an extremely beneficial feature in that it was able to playback the last hour of bird tracks within a few minutes. This feature proved extremely helpful in finding locations on the airfield with the greatest amount of recent bird activity. This information was of value as it helped us decide where to begin our wildlife observations for conducting this survey and potentially our future wildlife control work.

Display update rate – Although the GEC does integrate all three radars into one common display, its real-time update rate of 5 s was double that of the DRP software display (2.5 s). The value of viewing detections as close to real time as possible is a function of what we are asking it to do. The use of archived data is of great value to us, the airport operators, but a lag time of 15 to 20 seconds might very well be too imprecise to alert the tower or moreover to divert an aircraft on approach to a SEA runway.

Display Format - The tradeoff of using the DRP for this evaluation rather than the GEC, was its more limited user functionality. Rapidly zooming to an airfield location of interest was made more difficult with its limited ability to zoom. Because the GEC is specifically designed around superior user satisfaction and now has the one hour playback feature, improving its update rate and its ability to display plots as well as tracks is likely to result in a single preferred remote display system that can show all detections from all radars simultaneously.

7. *Please rate the following where 1 = poor, 2=fair, 3=good, 4=very good and 5 = excellent.*

The assigned numerical ratings were for the DRP unless specified otherwise:

Improved situational awareness 4

Please provide specific comments to support or expand your rating.

One of the greatest benefits of radar is its ability to monitor bird activity and their use on and near SEA on a 24/7 basis, even during conditions of light rain as we experienced during most of the evaluation. Although we experienced an increase in situation awareness of our airfield environment with respect to more bird being present than we had previously expected, an aviation hazard level is not something the system is currently designed to provide. The aspect of the end user interpreting a hazard level based on radar information and knowing when to react to these data is one that is expected to change with user experience and proficiency. However, our experience would suggest that the operator of a vehicle on an airfield might be served better through a sense and alert system rather than being solely dependent on a radar display. If it had been, we would have watched the real time radar display less frequently and perhaps only when truly necessary. Necessity in this instance would be based on a set of predetermined triggering event criteria that illustrated some of the more typical hazardous wildlife presence and behavior experienced at SEA. Triggering criteria such as target number, speed, or travel direction relative to important aircraft movement areas should be part of future evaluations in determining a hazard level for specific kinds of wildlife activity.

In contrast to our original goal of learning how this technology might increase situational awareness by notifying us of wildlife hazards earlier than with out the aid of radar, there was an instance when the display informed us that the hazard had passed and no further wildlife deterrent measures were needed. When a flock of several hundred starlings were harassed, the radar tracked them flying across the airfield while they dispersed in multiple westerly directions and flew clear of the airfield. This dispersal activity is something we could not easily see at the opposite end of the airfield even with binoculars. Knowing the hazard had passed saved us 15 to 20 minutes, the time to drive around and back from the opposite end of the airfield to confirm we had successfully dispersed the flock.

