

# Workshop Proceedings

## Introduction

Ocean wave information relies on the collection of oceanographic and meteorological data, analysis and interpretation of the data, and dissemination of the resulting information products. These products can range from statistical tables and charts to bulletins and technical reports. Operational oceanography is distinct in that the science is focused on the development of information products that are used for decision making. Ocean wave conditions are a major constituent in any operational plan and are important to support safe maritime activities such as navigation, loading ships, fishing, recreation, mineral extraction, power generation, and military exercises. This workshop goes beyond consideration of descriptive wave products such as spectra from buoys, hindcasts from historical weather records, and forecasts from wave models. It provides the opportunity for participants to share their procedures for preparing and distributing wave information products; workshop attendees will discuss how their products are actually used to support decision making.

Scientists, engineers, and managers have been invited to present ideas, research results, case studies, work in progress, and system demonstrations related to the use of wave buoys, models, and information to support operations. Discussions will highlight how wave information is used to make decisions such as the issuance of warnings to mariners, evacuation of coastal areas, routing of ships into favorable seaways, and efficient deployment of marine spill response equipment. This workshop provides a forum for operational oceanographers to stimulate discussion, provide new insights, and provide feedback for focused experiments.

The workshop pre-proceedings and proceedings will be made available through the workshop website, which can be accessed online at URL: <http://scholarworks.uno.edu/oceanwaves/>.

## Organizing Committee

### *Workshop Chairs:*

Dr. Brandon M. Taravella, P.E., *University of New Orleans* (Co-Chair)

Mr. C. Reid Nichols, *Marine Information Resources Corporation* (Co-Chair)

### *Moderators:*

Mr. Donald R. DelBalzo, *Marine Information Resources Corporation*      Session I

Mr. James D. Dykes, *Naval Research Laboratory*      Session II

Mr. Bruce Northridge, *Marine Information Resources Corporation*      Session III

Dr. Richard Price, *Computer Sciences Corporation*      Session IV

### *Rapporteurs:*

Ms. Elena van Roggen, *Marine Information Resources Corporation*

Dr. Robert G. Williams, *Marine Information Resources Corporation*

## Workshop Objectives

- Discuss technologies and applications that provide information on ocean waves.
- Improve the exchange of information on state-of-the-art wave measuring and modeling capabilities through cross-fertilization by participants of diverse backgrounds and areas of expertise.
- Share information on projects using ocean wave measurements to illustrate the kinds of problems and solutions encountered in real world oceanography.

- Show how ocean wave measurements contribute to meteorological/oceanographic projects.
- Enhance opportunities for others through the exchange of information and techniques.

## **Methodology**

Presentations, break-out groups, and guided discussions.

From material in the Pre-Proceedings, please email any break-out group discussion questions to [oceanwaves@uno.edu](mailto:oceanwaves@uno.edu).

## **Target Participants**

Oceanographers, engineers, scientists, Meteorological and Oceanographic (METOC) Services Officers, aerographer mates, marine science technicians, field supervisors and managers from academia, government, and industry.

## **Number of Participants**

The number of participants is limited to 50.

# Table of Contents

Introduction .....	1
<b>Organizing Committee</b> .....	1
<b>Workshop Objectives</b> .....	1
<b>Methodology</b> .....	2
<b>Target Participants</b> .....	2
<b>Number of Participants</b> .....	2
Opening Comments .....	4
<b>A Touch of History – Lake Pontchartrain and the Higgins Boat</b> .....	4
Session I – Use of wave measurements to save lives and protect property.....	5
<b>Extended Abstracts</b> .....	5
<b>Beach Profile Changes at Freshwater Beach in Queensland, Australia</b> .....	6
<b>Wave Buoys: Using the Right Tool for the Right Job</b> .....	7
<b>Wave Issues Relevant to the Operation and Maintenance of Seafloor Cables</b> .....	8
<b>Session Papers</b> .....	9
<b>Beach Profile Changes at Freshwater Beach in Queensland, Australia</b> .....	10
<b>Wave Buoys: Using the Right Tool for the Right Job</b> .....	13
<b>Session Presentation</b> .....	19
<b>Session Notes</b> .....	19
Session II – Development of wave modeling framework to support operations.....	21
<b>Extended Abstracts</b> .....	21
<b>Utility of Delft3D Forced With Low Grade Bathymetry</b> .....	22
<b>Update of WAVCIS and the Use of Its Data for Coastal Processes</b> .....	23
<b>Session Paper</b> .....	24
<b>Session Presentation</b> .....	24
<b>Session Notes</b> .....	24
Session III– Recent advances and issues in wave buoy technologies. ....	25
<b>Extended Abstracts</b> .....	25
<b>Circular-Slide Wave Energy Converter</b> .....	26
<b>Session Papers</b> .....	27
<b>Circular-Slide Wave Energy Converter</b> .....	28
<b>Session Presentation</b> .....	32
<b>Session Notes</b> .....	32
Session IV – Accessibility of wave information for scientists, engineers, and managers.....	33
<b>Extended Abstracts</b> .....	33
<b>Comprehensive Software Solution for the Management of Complex Oceanographic and Meta Data</b> .....	34
<b>Session Paper</b> .....	35
<b>Comprehensive Software Solution for the Management of Complex Oceanographic and Meta Data</b> .....	36
<b>Session Presentation</b> .....	41
<b>Session Notes</b> .....	41
Biographical Sketch.....	43
<b>Theodore Mettlach Scholarship Fund</b> .....	43

## Opening Comments

### A Touch of History – Lake Pontchartrain and the Higgins Boat

C. Reid Nichols<sup>1)</sup>

<sup>1)</sup> Marine Information Resources Corporation, Ellicott City, MD

The ability to conduct amphibious operations has been and continues to be an essential military capability used by many nations. Amphibious planners have many complex factors to consider and a major challenge involves the determination of waves, tides, and shallow-water processes that impact ride quality, seakeeping, and surf zone breaching for amphibious craft.

Prior to World War II, no landing craft other than small boats were utilized by military forces. Technologies that supported amphibious operations played a major role for the United States' successes during World War II. For example, the Navy and the United States Marine Corps favorably experimented with the Higgins Industries' Eureka Boat during Fleet Landing Exercises during 1939. The Eureka boat was originally developed to support oil drilling operations along the Gulf coast. As an amphibious craft it needed a better method for Marines to debark.

Based on feedback about Japanese landing craft (Fig. 1) following these amphibious exercises, Andrew Jackson Higgins (1886–1952) modified the Eureka boat by adding a bow ramp to support the debarkation of Marines and their equipment. The ramp-bow Eureka boat was demonstrated in Lake Pontchartrain and spawned development of the Landing Craft, Vehicle, Personnel (LCVP), also known as the “Higgins Boat.” At the close of World War II, Higgins Industries had delivered more than 20,000 boats. Mr. Higgins is credited with approximately 30 patents pertinent to amphibious landing craft and vehicles.



Figure 1. The Daihatsu Class or 14m landing craft used by the Japanese during WWII. (Obtained from World War II Database. Available online. URL: <http://ww2db.com>. Accessed on January 25, 2013).

The National D-Day Museum in New Orleans, Louisiana was instrumental in building and testing a replica LCVP designated PA33-21 by the United States Coast Guard during 1999. A picture from the sea trials on Lake Pontchartrain is provided in Fig.2. PA33-21 is owned by the University of New Orleans (UNO) Foundation, and is on permanent loan for display at the D-Day Museum. In

addition, the UNO library holds a significant collection (e.g., plans and drawings, company publications, photographs, publications referring to Higgins materiel and products) from Higgins Industries beginning in 1930 through 2000.



Figure 2. A LCVP cruising Lake Pontchartrain on Sunday, October 3, 1999 (Obtained from Higgins PT305 Restoration Project. Available online. URL: <http://www.higginsboats.com/>. Accessed on January 25, 2013).

Following the attack on Pearl Harbor on December 7, 1941, the Navy Hydrographic Office ramped up to support amphibious operations, which are especially challenged by coastal features such as coral reefs, surf zones, and tidal fluctuations. Data collected by ships such as the USS SUMNER were instrumental in updating tide predictions for many of the Pacific Islands. The Hydrographic Office was re-designated the U.S. Naval Oceanographic Office in 1962, and in 1976 the Office was relocated to what is now known as the John C. Stennis Space Center. Today, the Stennis Space Center is the location where scientists apply meteorological and oceanographic observations and numerical model data to provide information that supports the Navy's mission of deterring aggression and maintaining freedom of the seas.

It is for these kinds of reasons that the Ocean Waves Workshop is being conducted at University of New Orleans with a focus on sharing cutting-edge information to support operations.

#### References

Strahan, Jerry E. *Andrew Jackson Higgins and the Boats that Won World War II*. Baton Rouge, Louisiana State University Press, 1994.

Higgins Industries Collections, Earl K. Long Library, University of New Orleans, Available online. URL: <http://library.uno.edu/specialcollections/inventories/065.htm>. Accessed on Feb 15, 2013.

## **Session I — Use of wave measurements to save lives and protect property.**

This session will assess developments and applications in the field of wave monitoring and their practical use to help save lives and protect property. Various technologies that are used to accurately measure waves in the ocean will be highlighted, along with the impacts that the waves are having on structures. As an example, officials may close a coastal road after detecting overtopping waves. Similarly, understanding the manner in which waves generated by storms or watercraft cause beach erosion is important for coastal zone managers. Coastal erosion may take the form of the temporary loss of sediments, long-term losses, and the accretion of sediment at nearby locations. Participants will help define how wave research and observation programs culminate in providing information for end-users. The following paper and extended abstracts relate to the use of wave measurements to cope with a range of issues from coastal erosion and climate change to marine spill response and flooding.

### **Extended Abstracts**

# Beach Profile Changes at Freshwater Beach in Queensland, Australia

Elena van Roggen<sup>1)</sup>, Bradley Weymer<sup>1,2)</sup> and C. Reid Nichols<sup>1)</sup>  
<sup>1)</sup> Marine Information Resources Corporation, <sup>2)</sup> Texas A&M University  
\*Corresponding author: evanroggen@mirc-us.com

## 1. Introduction

During 2009 and 2012, the Remote Sensing Division of the Naval Research Laboratory conducted several multidisciplinary and integrated coastal studies at Freshwater Beach in Queensland, Australia to assess the utility of hyperspectral imagery to retrieve shallow water bathymetry and estimate trafficability parameters [1]. While oceanographic and geotechnical data were collected to support the exploitation of hyperspectral imagery, they also provided information on the manner in which wave and current action deposited and reworked sediments along beaches facing the Coral Sea. Data and information collected from these remote sensing studies have the secondary benefit of characterizing beach profile changes that were measured using GPS survey equipment. These changes are considered to be in response to wave energy experienced during storms occurring between remote sensing experiments.

## 1. Method

Beach surveying involved the use of kinematic GPS, Total stations (electronic distance meter and theodolite) and ground-based LiDAR. The combined use of these instruments made it possible to accurately gather large amounts of survey measurements quickly.

Water levels were obtained from a GPS buoy and traditional tide predictions. Kinematic GPS data were also used to provide beach profiles. Data from this buoy were essential to tide-synchronize imagery and to de-tide multi-beam echosounder data from very shallow water surveys.

Wave measurements were obtained from a wave buoy deployed offshore of MacKay. This station, located at 21° 02.375'S Latitude and 149° 32.750'E Longitude, has been measuring wave parameters since September 20, 1975. Maximum wave heights ( $H_{max}$ ) from two recent storms are provided in Table 1.

Table 1. Waves during documented Coral Sea storms [2].

Date and Time	$H_{max}$
08-03-2009 5:00pm	7.7m
21-03-2010 12:00am	9.4m

Extreme sea states from tropical cyclones, Coral Sea low pressure systems and, to a lesser extent, trade wind surges were identified from weather records. In addition, winds from the north and the south (along the Capricorn Channel) have the longest fetch. The largest peak wave (9.6m) occurring during Severe Tropical Cyclone Yasi was recorded near Townsville on 2 February 2011 [3]. The Department of Environmental and Resource Management reported a 5m storm surge. Considerable

beach erosion was identified following these storms.

A series of floods also impacted the Queensland coast, beginning in December 2010.

Fig. 1 displays beach profiles derived from data collection along with historical chart data at Freshwater Beach. Erosion since 2006 is visible, and may be attributed to recent wave action.

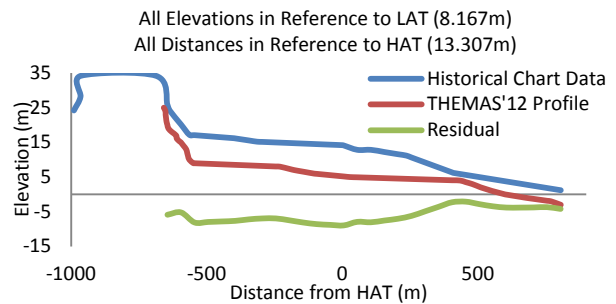

Figure 1. Northern Freshwater Beach profile. [4]

## 2. Results and Conclusions

Storms in the Coral Sea generate swells that sweep along the coastline. The average difference between beach profiles is -6.016m. This erosion is linked to episodic extreme weather events that have been associated with large waves. Shoreline retreat leads to greater landward encroachment of waves and flooding by the Coral Sea. Future analyses should systematically compare wave buoy data with beach profiles in order to determine the rate of the beach's recovery from these episodic weather events.

## References

- [1] Bachmann, C. M., R.A. Fusina, M.J. Montes, R-R Li, C. Gross, C.R. Nichols, J.C. Fry, C. Parrish, J. Sellars, S. White, C. Jones, and K. Lee, 2012. Talisman-Saber 2009 Remote Sensing Experiment, NRL Memorandum Report NRL/MR/7230—9404, Washington, D.C.: Naval Research Laboratory.
- [2] Wave Recording at Mackay. Available online. URL: <http://www.ehp.qld.gov.au/coastal/monitoring/waves/site.php?siteid=11>. Accessed on December 6, 2012.
- [3] Tropical Cyclone Yasi February 2011. Available online. URL: [http://www.ehp.qld.gov.au/management/pdf/tc\\_yasi\\_feb\\_2011.pdf](http://www.ehp.qld.gov.au/management/pdf/tc_yasi_feb_2011.pdf). Accessed on December 6, 2012.
- [4] Weymer, Bradley A., Elena van Roggen, Chris Houser, and Rick Giardino, 2012. Alongshore variability in beach planform and foredune height of an embayed beach: Shoalwater Bay, Queensland, Australia. American Geophysical Union Fall Meeting, San Francisco, CA

# Wave Buoys: Using the Right Tool for the Right Job

Robert G. Williams<sup>1)\*</sup>, C. Reid Nichols<sup>1)</sup> and Tony Ethier<sup>2)</sup>

<sup>1)</sup> Marine Information Resources Corporation, Ellicott City, MD

<sup>2)</sup> AXYS Technologies Inc, Sidney, British Columbia, Canada

\*Corresponding author: rwilliams844@gmail.com

## 1. Introduction

Wave buoys measure water level fluctuations that are caused by astronomical forces, winds, and events such as earthquakes. The water level fluctuations are the manifestation of energy being transferred across the surface of the ocean [1]. Wave buoy data are used to determine factors such as wave height, period, and direction. The data support wave forecasting over spatially extensive regions and products that are useful to save lives and protect property. Data from the wave buoys are used to verify and validate information from platforms such as wave gliders or numerical models. Information from properly sited wave buoys improves severe weather forecasting. There are also many types, sizes, and configurations of wave buoys since they may be used for a variety of purposes [2]. They are large and small, directional and non-directional, and drifting and moored. Modern wave buoys measure and transmit automatically, in a predictable and controlled way, communicating in real time via radio, cell phone, or satellite.

Regardless of size and type, floating wave buoys, the most widely used, move in synchronization with the wave motion. All wave buoys measure the frequency and amount of wave energy, usually the wave height. Processing of the collected data is accomplished by spectral analysis and the zero crossing method, where parameters such as significant wave height, peak wave period, and average wave period are derived for the buoy location. The size and type of buoy are determined based on environmental conditions associated with the deployment location. There are small air-deployed wave buoys, larger coastal buoys, and heavy and durable deep sea wave buoys. Some examples are provided in Fig. 1. In general, raw data is processed onboard the buoy and then transmitted to a receiving station. Operational buoys, regardless of size, make wave data available immediately after acquisition and processing.

It is important to remember that the size of the buoy will determine the size of the wave that can be measured effectively. A small buoy can measure shorter wavelengths. Thus, deploying a large buoy designed to respond to long deep-ocean waves would provide insufficient information in an estuary. Providing a mooring designed to minimize impacts on anchored buoy data is also an important consideration. A buoy suited to measuring tides will do a poor job of recording high-frequency gravity waves, which would be of interest to radar engineers.

The shape of the buoy will also impact the quality of the wave information. Dimensions for some standard buoys that are used operationally are listed in Table 1. In essence the buoy shape will determine the overall response of the buoy to wave motions, i.e., heave, pitch, and roll. The frequency responses of the individual

sensors must also be matched to that of the buoy to provide the desired environmental information. Scientists, engineers and naval architects may be very interested in using the data to assess the response of electromagnetic or acoustic radiation, structures, and vessels to wave forces.

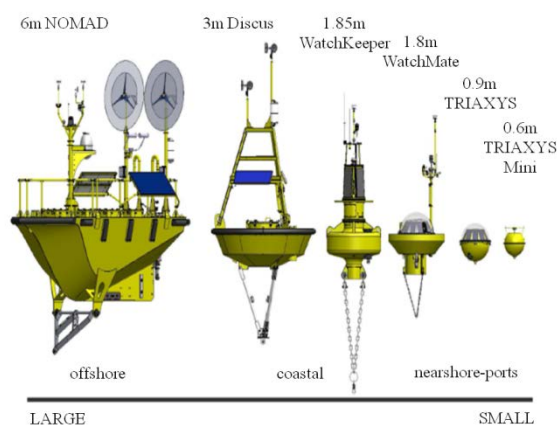

Figure 1. Wave buoy sizes and shapes.

Table 1. Standard buoy diameters.

Name	Standard Buoys		
	Brand Name	Basic Shape	Diameter
Waverider	Spherical	0.9m	212Kg
TRIAXYSTM	Spherical	1.10m	197Kg
Seawatch	Discus	1.76m	710Kg

## 2. Conclusion

Wave buoys by their nature follow the waves. In so doing they measure the basic characteristics of a number of surface gravity waves, which in general are described by their wavelength. Examples include sea, swell, seiches, tsunamis, and tides. An important measure, often overlooked, is the ability for the wave buoys to measure the approximate location of the air-sea interface. The interface is a complex and important region to understand. The process of wave breaking, as evidenced by white-caps and surf, impacts the wave measurement process. Correct wave buoy selection and employment requires a basic understanding of the location's environmental conditions and the inventory of available commercial wave buoys.

## References

[1] U.S. Army Corps of Engineers. Engineering and Design: Coastal Engineering Manual. Washington, D.C. Dept. of the Army, U.S. Army Corps of Engineers, April, 2008.

[2] Nichols C.R., and R.G. Williams. Encyclopedia of Marine Science. New York, Facts On File, 2009.



# Wave Issues Relevant to the Operation and Maintenance of Seafloor Cables

Jeffrey S. Hoel <sup>1)\*</sup> and LCDR Grady Donathan <sup>2)</sup>

<sup>1)</sup> Naval Seafloor Cable Protection Office, Washington, DC

<sup>2)</sup> Naval Facilities Engineering Command, Washington, DC

\*Corresponding author: jeffrey.hoel@navy.mil

## 1. Introduction

Scientists and engineers working at the Naval Seafloor Cable Protection Office (NSCPO) design undersea fiber-optic and power cable systems while providing cable stabilization, cable route selection, shore landings, and cable deployment methods. Navy seafloor cable systems are found at fleet underwater training ranges and include sensor networks, communications and data links, and surveillance and monitoring systems. They are normally depicted on nautical charts so mariners can avoid them. Installation and maintenance is expensive and normally requires the use of Remotely Operated Vehicles, manned submersibles, and Cable Repair Ships.

Seafloor cables are typically laid along the bottom, but they can also be buried or trenched. Cables are sometimes buried to avoid being damaged by fishing gear or boat anchors. Seafloor cable locations are generally known within a radius of a few hundred meters and their heading is generally known within 20 degrees. Cable runs may be 5 to 40 km long in water depths from 25 meters to 5 kilometers. Range cables have a diameter from 1.6 to 3.2 cm with internal steel strength members. The cables are typically covered with either a black or white colored polyethylene jacket or occasionally, in shallow water, with a black jute wrapping. Some examples are illustrated in Fig. 1. Shallow water seafloor cables are especially prone to scour and burial, especially following severe weather. For this reason it is very important to understand wave height and direction distributions. The magnitude of general scour can be estimated from the annual extreme wave height.



Figure 1. Seafloor cables include telecommunication and power cables.

Underwater inspections provide valuable information to assess the seafloor cable condition and planning for scheduled maintenance or repair operations. Efforts are underway to explore the use of Unmanned Underwater

Vehicles (UUVs) to locate, follow, and inspect seafloor cables. If they can provide quality controlled data, a significant savings can be made on the cost of cable inspections. This may be especially valuable for the execution of unscheduled maintenance.

Most operational UUVs have been designed for deep-sea work at depths where wave forces are not a factor. One concern in the use of UUVs for shallow water seafloor cable inspections is the effect of waves on the corresponding motions of the UUV, especially with respect to different wave frequencies and headings. This will be especially important along shallow water seafloor cable runs where there is a need for high-resolution close-up video. The UUV operating in shallow water will have to adapt to an ever changing environment. It will have to remain on course, avoid obstacles, and track seafloor cables that may have been buried by the effects of waves and currents.

## 2. Conclusions

The NSCPO uses available environmental data to make objective science-based decisions. Observed data are used in the calculation of environmental loads acting on seafloor cables and other underwater structures [1]. The environmental loads are caused by phenomena such as waves and currents and their interactions, especially with the seafloor (e.g. sand, gravel and rocky bottoms). Wave information from buoys and models is especially important, e.g., to forecast scour and burial. Wave information is also useful to plan for the recovery and repair of seafloor cables.

NSCPO needs to identify UUV technologies that support the collection of shallow water seafloor data and cable conditions. The ideal platform would include synthetic aperture sonar, a multi-beam echo sounder, optical cameras, and lighting. Wave information would be essential to identify conditions when the UUVs could be used for cable inspections that include photographs and video that documents the seafloor cables from various angles. A viable UUV technology will become important to service ocean renewable energy technologies that rely on submarine electrical cables to bring generated electricity to shore.

## References

[1] Thompson, D. and D.J. Beasley (Ed.), Handbook for Marine Geotechnical Engineering, SP-2209-OCN, Naval Facilities Engineering Command, Washington Navy Yard, D.C., 2012.



**Session Papers**

(This page intentionally blank)

# Beach Profile Changes at Freshwater Beach in Queensland, Australia

Elena van Roggen<sup>1)</sup> and C. Reid Nichols<sup>1)</sup>

<sup>1)</sup> Marine Information Resources Corporation

\*Corresponding author: [evanroggen@mirc-us.com](mailto:evanroggen@mirc-us.com)

**Abstract**—Environmental factors such as waves, temperature, and beach gradients are very important for amphibious planning. At the Shoalwater Bay Training Area in Queensland, Australia, beach profiles changes measured from nautical charts, and surveys in 2009 and 2012 are considered to have been caused by severe storms and in particular the relationship between wave height and wave period. Future work to look at changes in wave steepness in association with erosion and accretion would support the management of Freshwater Beach.

## 1. Introduction

During 2009 and 2012, the Remote Sensing Division of the Naval Research Laboratory conducted several multidisciplinary and integrated coastal studies at Freshwater Beach in Queensland, Australia to assess the utility of hyperspectral imagery to retrieve shallow water bathymetry and estimate trafficability parameters [1]. While oceanographic and geotechnical data were collected to support the exploitation of hyperspectral imagery, they also provided information on the manner in which wave and current action deposited and reworked sediments along beaches facing the Coral Sea. Data and information collected from these remote sensing studies have the secondary benefit of characterizing beach profile changes that were measured using GPS survey equipment. These beach changes are considered to be in response to wave energy experienced during storms occurring between remote sensing experiments.

Understanding the effects of wave and storm surge action on beach profiling will help not only predict gradients on unfamiliar beaches, but also predict changes to known beach profiles where military training takes place. Both predictions are essential for the planning of surf zone breaching by amphibious vehicles including air cushion vehicles (or hovercraft), as well as for the safety of those attempting to traverse the dune system from the foreshore. Over-water performance for hovercraft is also greatly impacted by wave height and period while slope and “step-up” have to be considered for surf zone breaching and overland movement.

The Queensland coast is often subject to multiple tropical cyclones per year, and has seen a number of severe cyclones in the past seven years. Tropical cyclone Yasi in 2011, one of the strongest cyclones in recent history, had wind speeds of up to 285km/h and a 5m tidal surge [3]. Tropical cyclone Ului in 2010 had wind speeds up to 215km/h and a storm surge of 2.45m. Tropical cyclones and Coral Sea low pressure systems, all of which produce gale-force winds along the Queensland coast, have an almost 50% chance of being followed by another storm event within 60 days [5]. The frequency of such events fluctuates annually and is influenced by the

Southern Oscillation.

Cyclone effects are amplified in the region of the study area for two reasons. First, the Swain reefs at the southern tip of the Great Barrier Reef lie about 100km off the coast of Freshwater Beach, creating the Capricorn Channel (Fig. 1). This channel funnels winds and currents into a northwest/southeast direction along the coast, the direction with the longest fetch [5]. Secondly, the average cyclone path travels from east to west just north of the study area (Fig. 2). The clockwise rotation of tropical cyclones causes areas just south of their paths to be hit with the highest wind speeds when approaching the coast. Thus, the southern Queensland coast receives some of the worst cyclone effects.

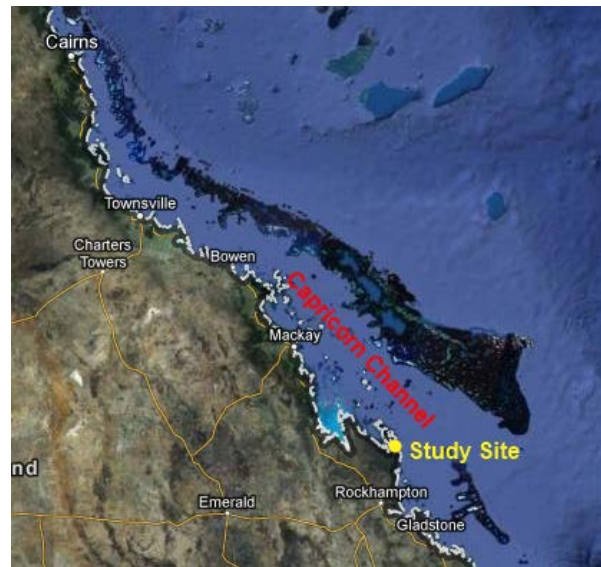

Figure 1. Location of the Capricorn Channel in relation to the study site.

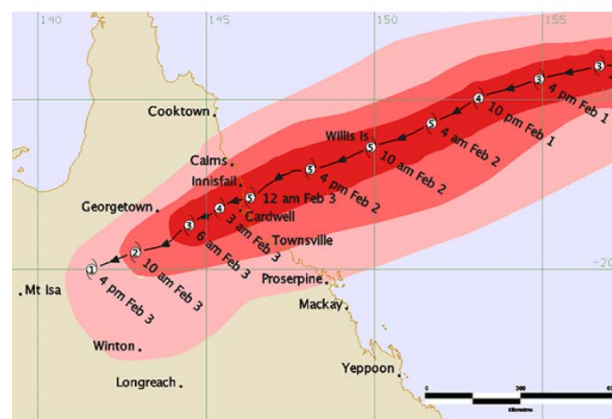

Figure 2. Path of tropical cyclone Yasi [3].

A series of recent floods also impacted the Queensland coast, beginning in December 2010, with a high concentration of moderate to major floods in the Rockhampton area. The Fitzroy river, whose watershed includes the study area, reached one of its highest depths ever recorded of 9.20m in early January 2011 [6]. Such

severe flood events may have contributed to the observed beach profile changes at Freshwater Beach in the form of sediment accretion.

### 3. Methods

Beach profiles prior to 2009 were calculated from nautical charts, while kinematic GPS was used to measure beach profiles during 2009. The most recent surveys during 2012 involved the use of kinematic GPS, Total Stations (electronic distance meter and theodolite) and ground-based LiDAR. The combined use of these instruments made it possible to accurately gather large amounts of survey measurements quickly. Kinematic GPS data were also used to provide beach profiles.

Water levels were obtained from a GPS buoy and traditional tide predictions. Data from this buoy were essential to tide-synchronize imagery and to de-tide multi-beam echosounder data from very shallow water surveys.

Wave measurements were obtained from wave buoys managed by the Queensland Government Department of Environment and Heritage Protection at various locations surrounding the study site. These Datawell 0.9m diameter GPS Waverider buoys include lengths of rubber in their moorings to allow for stretching up to three times its length [2]. Wave heights and periods are recorded, in addition to wave direction and sea surface temperature [2]. Significant wave height, maximum wave height, period and zero crossing period, direction, and temperature are collected as averages every 26.6 minutes. Fig. 3 shows a diagram of the Waverider buoy components.

Buoys were deployed offshore of MacKay, Hay Point, Emu Park, and Gladstone – locations both north and south of the study site (Fig. 4), with a maximum distance around 215km. Table 1 provides station data for each buoy, including installation date and water depth.

Wave buoy data from the eight most recent storm events impacting the study area can be compared to beach profiles. These events included tropical cyclones Jim, Larry, and Wati from 2006, Hamish from 2009, Ului from 2010, Anthony and Yasi from 2011, and Oswald from 2013. As an example, plots of significant wave height, period, direction, and sea surface temperature during the storm events for Mackay are included in Fig. 5.

The average wave direction of all buoys during storm events is approximately 100° from true north. This is comparable to the angle of the Queensland coast in the study site's region, and also comparable to the angle of the Capricorn Channel from true north. This further proves the power of the channel to direct winds, and therefore waves, toward the study area parallel to the coast.

The maximum wave height for all buoy locations and storm events occurred at McKay with a height of 9.44m during tropical cyclone Ului. Ului also had some of the highest average wave heights between the four buoy

locations.

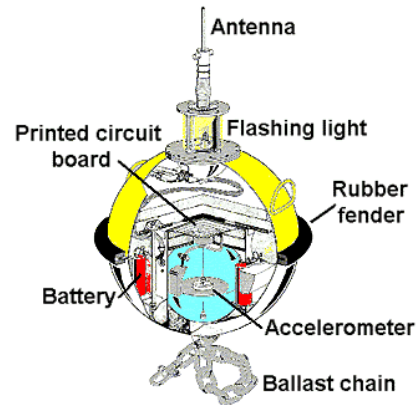

Figure 3. Datawell 0.9m GPS Waverider buoy [2]



Figure 4. Locations of wave buoys in relation to the study site

Table 1. Wave buoys surrounding the study site [2].

	Latitude	Longitude	Start Date	Depth
Mackay	21° 02.375'S	149° 32.750'E	20/9/75	28
Hay Point	21° 16.276'S	149° 18.572'E	3/2/93	10
Emu Park	23° 18.380'S	151° 04.380'E	24/7/96	18
Gladstone	23° 53.670'S	151° 30.220'E	23/7/09	13

Beach profiles derived from data collection along with historical chart data at Freshwater Beach are displayed in Fig. 6. Erosion since 2006 is visible, and may be attributed to recent storm wave action.

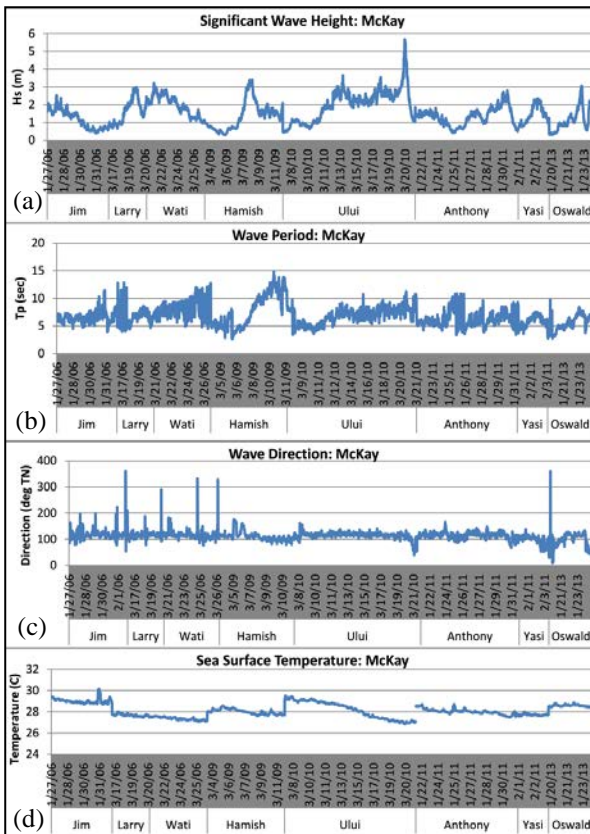

Figure 5. Wave buoy records at Mackay during recent storm events [7]. Accessible data included (a) significant wave height (b) dominant or peak wave period (c) wave direction (d) and sea surface temperature.

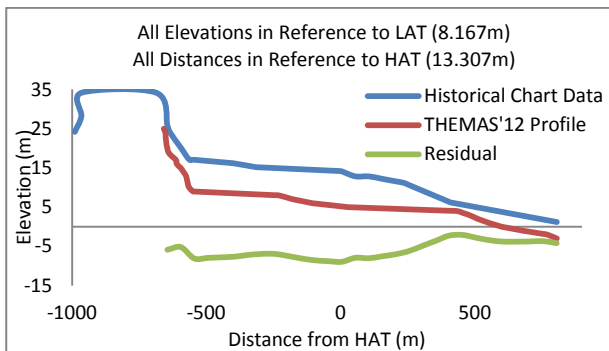

Figure 6. Northern Freshwater Beach profile. [4]

#### 4. Results and Conclusions

The average difference between beach profiles (Fig. 6) is -6.016m. By observation, this erosion is linked to episodic extreme weather events that have been associated with large waves, such as those associated with the storm events previously mentioned. This, along with impacts from currents, flooding events, and other natural processes may explain the changes in Freshwater Beach's profile over the past seven years.

While large waves are typically thought of as being responsible for beach erosion, the relationship between wave height and wave period is also significant. Longer period waves tend to result in less erosion than the shorter period waves.

Wave steepness, a parameter used to describe the ratio of

a wave's height to its length, may also be used to understand beach erosion. When the steepness is greater than approximately 0.025, the waves are considered erosional, while those less than 0.025, are considered accretional [8]. The calculation of wave steepness requires not only wave height, but also wavelength - a parameter not included in public data provided by the Queensland wave monitoring program.

A more accurate estimation of the effects of extreme wave actions on beach profiles is difficult without having access to long-term wave observations, currents, and water level records. At a minimum, the computation of wave steepness should be standard for wave buoy measurements and recording, and should be easily accessible to the public as a complement to basic wave records. This additional information would be useful to compare with beach profile changes and is an important factor to help prevent capsizing by boaters.

Shoreline retreat leads to greater landward encroachment of waves and flooding by the Coral Sea. Future analyses should systematically compare wave buoy data with beach profiles in order to determine the rate of the beach's recovery from these episodic weather events. Such studies would provide insight into shoreline morphology beneficial for land use planning, development, tactical planning, and numerous other applications.

#### References

- [1] Bachmann, C. M., R.A. Fusina, M.J. Montes, R-R Li, C. Gross, C.R. Nichols, J.C. Fry, C. Parrish, J. Sellars, S. White, C. Jones, and K. Lee, 2012. Talisman-Saber 2009 Remote Sensing Experiment, NRL Memorandum Report NRL/MR/7230—9404, Washington, D.C.: Naval Research Laboratory.
- [2] Wave Recording at Mackay. Available online. URL: <http://www.ehp.qld.gov.au/coastal/monitoring/waves/site.php?siteid=11>. Accessed on December 6, 2012.
- [3] Tropical Cyclone Yasi February 2011. Available online. URL: [http://www.ehp.qld.gov.au/management/pdf/tc\\_yasi\\_feb\\_2011.pdf](http://www.ehp.qld.gov.au/management/pdf/tc_yasi_feb_2011.pdf). Accessed on December 6, 2012.
- [4] Weymer, Bradley A., Elena van Roggen, Chris Houser, and Rick Giardino. 2012. Alongshore variability in beach platform and foredune height of an embayed beach: Shoalwater Bay, Queensland, Australia. American Geophysical Union Fall Meeting, San Francisco, California.
- [5] Queensland Government, Environmental Protection Agency, 2004. Mackay Coast Study Report, chapter 10: Waves. Available online, URL: <http://www.ehp.qld.gov.au/register/p01549aj.pdf>. Accessed on January 25, 2013.
- [6] Australian Government Bureau of Meteorology, 2011. Flood Warning System for the Fitzroy River. Available online, URL: <http://www.bom.gov.au/qld/flood/brochures/fitzroy/fitzroy.pdf>. Accessed on February 7, 2012
- [7] Coastal Impacts Unit: Department of Science, Information Technology, Innovation and the Arts. Deagon, Queensland Australia
- [8] The Jersey Shoreline, 2010. Rethinking Storm-Related Beach Erosion. Available online, URL: [http://www.njseagrant.org/jersey-shoreline/vol26\\_no4/articles/r ethinking-beach-erosion.html](http://www.njseagrant.org/jersey-shoreline/vol26_no4/articles/r ethinking-beach-erosion.html). Accessed on February 26, 2013.



## Wave Buoys: Using the Right Tool for the Right Job

Robert G. Williams<sup>1)\*</sup>, C. Reid Nichols<sup>1)</sup> and Tony Ethier<sup>2)</sup>

<sup>1)</sup> Marine Information Resources Corporation, Ellicott City, MD

<sup>2)</sup> AXYS Technologies Inc, Sidney, British Columbia, Canada

\*Corresponding author: rwilliams844@gmail.com

**Abstract**—Wave buoys measure water level fluctuations that are caused by astronomical forces, winds, and events such as glacier slides. There are also many types, sizes, and configurations of wave buoys since they may be used for a variety of purposes. They are large and small, directional and non-directional, and drifting and moored. Buoy selection should be determined based on environmental conditions associated with the deployment location and information needs. Modern wave buoys measure and transmit automatically, in a predictable and controlled way, communicating in real time via radio, cell phone, or satellite. All wave buoys measure the frequency and amount of wave energy, usually the wave height. More sophisticated wave buoys are used to determine wave height, period, and direction. Information from properly sited wave buoys improves severe weather forecasting.

### 1. Introduction

Today's marine research and operations managers are confronted by a sometimes bewildering array of wave-measuring buoy systems. Buoys come in a variety of sizes and shapes, mooring methods and configurations, sensor types, communication and data processing systems. Some can be hand-deployed by one or two people, while others require onboard cranes and a dedicated crew. Prior to purchase, fabrication and deployment, users need to fully understand their requirements, which include environmental factors, hardware and software capabilities, and limitations prior to sourcing the wave buoy that is optimal for their needs.

Wave sensors for buoy deployment generally include accelerometers or GPS receivers, compasses, with associated computer processors, power supplies, and communication equipment [1]. The buoy must measure all components of motion needed to obtain wave data. Wave buoys can provide users with non-directional or directional wave data. Directional wave buoys require additional sensors to measure the tilt, and possibly the curvature of the sea surface. All wave measuring buoys report wave height and period, or wave height, period, and direction, from which the data products that the user desires can be derived.

Buoy developers have designed an array of hull forms and moorings to survive deployments in the marine environment. There are small air-deployed wave buoys, larger coastal buoys, and heavy and durable deep sea wave buoys. Some examples are provided in Fig. 1 [2].

### 2. Buoy Types Based on Deployment Locations

Buoys can be categorized based on where they are deployed. They are usually designed to measure directional wave properties and can usually be deployed Ocean Waves Workshop (<http://scholarworks.uno.edu/oceanwaves/>)

from a vessel by a team of 2 to 8 people. Buoys designed for smaller and/or protected bodies of water can be smaller, lighter, and will be easier to handle. More robust buoy systems are found in coastal waters. The smallest buoys are lightweight, easily transported, deployed, and retrieved by hand from a small boat with a one- or two-person crew, usually for short durations of hours to days.

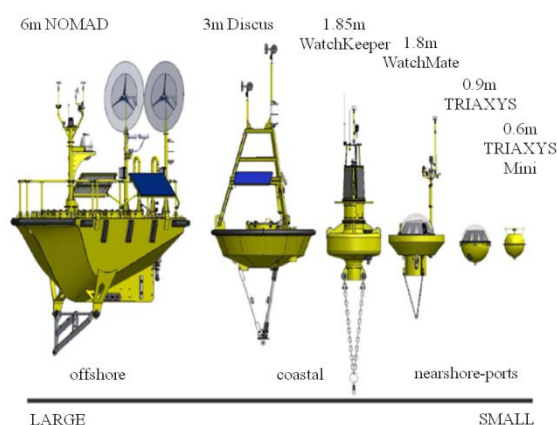

Figure 1. Wave buoy sizes and shapes.

Coastal wave buoys, and buoys suitable for deployment in lakes and rivers are of larger size than hand-deployable variants. They require strong mooring tackle, and reliable and rugged components, and either line-of-site radio or cell phone communications. They are deployed into the coastal ocean using ships equipped with cranes under the guidance of a Deck Chief and several deck hands. National Oceanic and Atmospheric Administration (NOAA) buoys that comprise the National Data Buoy Center (NDBC) Ocean Observing System of Systems are often serviced using U.S. Coast Guard Cutters (USCGCs). Fig. 2 is a picture of USCGC ASPEN that services NOAA buoys sited along the central California coast



Figure 2. Buoy tender in San Francisco Bay.

Deep sea wave buoys are heavy with diameters of approximately twelve meters or so. Some of the earliest deep sea buoys were of the doughnut type, such as the Richardson buoy (now known as toroidal buoys), disk shaped, such as the Monster buoy, or boat-shaped, such

as the NOMAD (Navy Oceanographic Meteorological Automatic Device) buoy. These buoys require extensive mooring tackle for deployment in depths of 4,000 m or more and great survivability. They may be deployed from months to years. Usually, RF data transmission via satellite is employed, but many buoys are equipped with internal digital recorders in case communications are severed due to severe weather or other damage. In some cases, internal data recording is more detailed than the real-time transmissions, and suitable for subsequent scientific analysis.

In most deployments, raw data are usually processed onboard the buoy and then transmitted as wave height, wave period and direction, and ancillary parameters such as temperature, salinity, current speed and direction, wind speed and direction, as well as engineering data to assure that the buoy is responding correctly.

The most useful wave buoys, regardless of size, make wave data available immediately after acquisition and processing, via a communication system such as a VHF radio modem which may be line-of-site for coastal buoys, or RF linked to a satellite, and connected through the Internet, where it can be made immediately available to users. In a few cases, near-shore buoys are hard-cabled to an ocean observatory or a station on shore. Sub-surface buoys using pressure gauges, or “inverted fathometers” to sense the sea surface may use acoustic transmission to send the data to a surface buoy equipped with receiving hydrophone and decoder to transfer the data to an RF link for transmission to the users.

Design fundamentals depend heavily on the intended application, whether near-shore or deep sea, for short or long deployment, for severe or moderate currents and sea states, and for the possibility of icing, biological fouling, chemical corrosion, and so forth. In today’s global economy and consequent high volume marine traffic, survivability in the event of collisions or near collisions with ships may be an important design consideration; as well as resistance to vandalism or unauthorized tampering. The chosen design for the buoys and sensors must allow for good functionality and reliability under a variety of conditions. Sensors must be able to function in all situations of interest. Wind sensors that are destroyed by hurricane winds are of no value to the user.

Directional and nondirectional buoys are deployed for various applications. Nondirectional buoys are simpler, cheaper, have been in use for many years, and are the system of choice if only wave height and period are required. Directional buoys require additional sensors, more complex and costly data processing and analysis, and final archiving. In many cases in the past, however, nondirectional buoys were used when directional data were really needed because of limitations with the technology. Reliable, cost-effective directional buoys are a fairly recent development in oceanography [3].

### 3. Diameter, Shape, and Size

Wave buoy users that depend on processing software that Ocean Waves Workshop (<http://www.oceanwavesworkshop.uno.edu>)

converts buoy motions to wave motions are immediately confronted with issues surrounding the wave spectrum. The buoy must follow the motion of the water particles at the surface in the vertical (z) and horizontal (x,y) directions. Owing to the finite size of the wave buoy, it will not be able to follow waves that are smaller than the buoys approximate diameter. Thus, the limiting frequency is called the cut-off frequency and is a function of the diameter; hence the shortest wavelength that a buoy can follow is determined by the size of the buoy. Furthermore, the shape of the buoy determines its responsiveness to vertical wave motion. For example, strong resonances at the immersion frequency result in overestimated vertical motions for elongated buoys. Mooring lines can induce response phenomena associated with horizontal wave motions, Buoy rotations are of importance for wave motion sensors that are placed outside the buoy center of rotation, such as GPS. In this respect, determination of the pitch-roll resonance frequency is important. The vertical dimension of the buoy is also of importance since wave motions diminish with depth. Measurements from the deeper parts of the buoy will not be equal to those taken at the surface.

Wave buoy measurements will be confounded by breaking seas, where the hull is subjected to large accelerations. Under such conditions, the measurements may overestimate or underestimate the actual wave heights. The mooring tackle or tethering line must be designed to minimize distortions of the free floating buoy motions.

In summary, a buoy suited to measuring low-frequency tides will do a poor job of recording high-frequency gravity waves. The size, shape, buoyancy and weight are immediate constraints on the buoy frequency response. The frequency responses of the individual sensors must also be matched to that of the buoy to provide the desired high quality data. Dimensions for some standard buoys that are used operationally are listed in Table 1.

Table 1. Standard Buoys currently in use, worldwide.

Name	Standard Buoys		
Brand Name	Basic Shape	Diameter	Weight
Waverider	Spherical	0.9m	212Kg
TRIAXYS™	Spherical	1.10m	197Kg
Wavescan	Saucer	1.76m	710Kg
Mini Waverider	Spherical	0.40 m	17Kg

### 4. Sensors

A great variety of sensors are available to the user for the measurement of waves. Primary wave sensors include accelerometers, flux gate compasses, rate gyros, pressure gauges, wave staffs, upward looking acoustic sensors. GPS buoys do not use accelerometers. Instead, they use the Doppler shift in the GPS signal to determine the velocity of the GPS receiver relative to the satellites. When the GPS receiver moves toward (away from) the satellite it experiences an increase (decrease) in the GPS



signal frequency that is proportional to the velocity of the buoy. Integrated over time this Doppler shift yields the relative buoy displacements.

Ancillary sensors include thermistor temperature gauges, conductivity sensors, current speed and directions sensors, such as acoustic Doppler profilers, wind sensors such as anemometer cup and wind vane, acoustic or laser wind profilers. All have advantages and disadvantages. Wave staffs are not seen very often on today's oceanographic buoys because of greater vulnerability and maintenance requirements, pressure gauges are also not often used because of the attenuation of high frequency waves with depth. Most wave buoys probably use accelerometers in height only measurements, and accelerometers, flux gate compasses, and rate gyros in directional buoys.

Ideally, individual testing and calibration of sensors should be done in a laboratory or wave tank, and then tested as an entire system on the buoy in the field. Issues with calibration-sensor calibration, including onboard calibration under the limit of expected environmental conditions should be uncovered and corrected during this testing phase.

## 5. Power and Maintenance Requirements

Most buoys today are powered by internal batteries; battery life can be considerably extended by means of solar collectors (Fig. 3). Short deployments of small buoys, such as for military purposes can be powered with high-technology non-rechargeable batteries; long duration deployments, such as for monitoring or providing navigation information can be powered with rechargeable batteries that can be recharged during periods of regularly scheduled maintenance. State-of-the-art buoys use solar panels to recharge the batteries, thus providing greatly extended battery life, and opening up opportunities for much longer buoy deployments. Maintenance requirements can vary greatly depending on the harshness of the environment, and the likelihood of collisions with commercial vessels, or damage due to vandalism.

## 6. Deployment Methodologies

Most drifting and moored wave buoys are deployed by merchant or research vessels from the lowest deck or ramp. Deployment methodologies vary greatly depending on buoy size, duration of deployment, severity of environmental conditions. The buoy is usually deployed first, followed by mooring line and then the anchor (Fig 4). Small buoys can be deployed from small boats with a small team, perhaps with divers (Fig. 5); coastal buoys will require winches and a few strong mariners, deep sea buoys may require buoy tenders, specialized vessels with cranes or A-frames, and a trained deployment team. Deck space must be allowed to flake out the mooring line and tackle in the proper deployment configuration in either buoy first or anchor first procedures. Then the deployment team can get inventive as logistics dictate.

Ocean Waves Workshop (<http://scholarworks.uno.edu/oceanwaves/>)

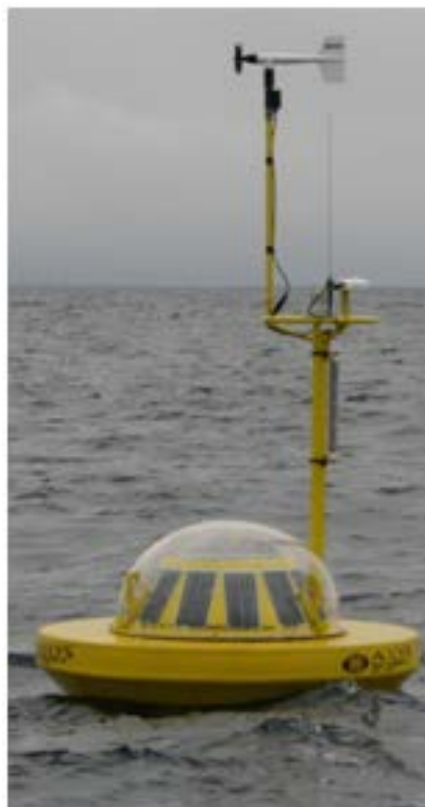

Figure 3. Close-up picture of a solar powered WatchMate™ Buoy.



Figure 4. TRIAXYS™ Directional Wave Buoy with ADCP Launch.



Figure 5. Wave buoy deployed with a canoe off of Ghana.

## 7. Data Processing

Onboard the wave buoy all of the basic wave measurements are derived in some way from the estimated energy spectra of a time series of buoy motion. For nondirectional wave buoys, an accelerometer measures wave height by recording the vertical acceleration of the buoy as it rises and falls with passing waves. Double integration of the acceleration produces the time series of wave height. Directional wave measurement systems require in addition to the measurement of vertical acceleration or heave (displacement), buoy azimuth, pitch and roll. These allow east-west slope and north-south slope to be computed. Processing of the collected data is accomplished by spectral analysis and the zero crossing method, where parameters such as significant wave height, peak wave period, and average wave period are derived for the buoy location [4].

The most useful buoys today transmit desired data and data products in real-time. This capability requires onboard processing and computing. A sampling strategy must be devised to provide the data and data products at the required time increments.

Quality control algorithms must be built into the data processing algorithms. Noise bursts, missing data, outliers, and other bad data points must be edited out before the data can be released for application.

Data displays must allow for a quick assimilation of the environmental picture in order to give managers the needed information in time to take action. Examples would include optimal ship tracking, military go/no go criteria, and air-sea rescue operations. The real-time data might profitably be backed up by onboard recording for more detailed analysis at a later time.

The onboard-recorded data is often at a higher sampling rate than that required for real-time products, to allow for science and engineering research studies, and for developing wave atlases and climatologies subsequent to the initial deployment.

## 8. Communications

Communication systems can be simple, especially for small buoys using cell phones and/or cable. Coastal buoys are likely to require VHF or UHF line-of-sight radio, or RF satellite links; deep sea buoys are likely to require RF satellite links using such systems as Iridium, Inmarsat, GPRS, etc.

## 9. Data Products

A variety of wave buoy products support the maritime industry [3]. Examples include wave height and period probabilities, wave slope, recent observations, wave spectra, and time series. Parameters include wave height, wave period, and direction. Wave height is usually reported as significant wave height. This value is approximately the average of the highest 1/3 waves, Ocean Waves Workshop (<http://www.oceanwavesworkshop.uno.edu>)

which is not the highest wave that a mariner will encounter. The upper end of the range is approximately 1.5 times the significant height. This is closer to the largest swell that may occur during a forecast period. Dominant and average wave period tend to be reported. Wave direction is reported in degrees. These products improve navigation by providing knowledge of prevailing sea-state conditions. Marine operators use these data to understand the dynamic behavior, safety, and operability of ships in the vicinity of the buoy. Thus, access to real-time wave measurements 24 hours a day and seven days per week increases safety and the effectiveness of sea transport. Products cannot be developed during buoy outages which are generally caused by:

- mooring failure
- collisions and broken hulls
- physical damage to electrical system components or critical sensors
- degraded cables (power and telemetry)
- lightning strikes that disable the electrical systems

Some of these failures are related to vandalism, which has to be considered in selecting sites.

Many times, buoy deployments are designed to satisfy several users with varying requirements [5], such as operations, monitoring, and research. These requirements must drive the raw data transmission vs. onboard processing considerations. Raw data are seldom of immediate value unless quality control is included in the data acquisition software. Time series of short records with high resolution may be needed for high wave conditions, longer time series giving good statistical stability are also needed for calculation of products, such as significant wave height, wave steepness, dominant wave direction, height-direction histograms, non-directional and directional spectra. Modern algorithms such as maximum entropy facilitate calculation of spectra using relatively short time series. Wave characteristics can often be calculated on relatively short time series using FFT techniques, allowing for a good compromise between resolution and statistical stability.

## 10. Conclusions

One must consider environmental factors when selecting the optimal wave buoy for a particular site. Based on mooring location, the user will pick the appropriately sized and shaped hull. Sizes will range from mini drifting data buoys to large 12-m diameter discus buoys. Buoys tend to have sphere, saucer, and boat shaped hulls. The moorings are designed based on hull type, location, and mooring depth. Smaller buoys may be deployed in shallow coastal waters using an all-chain mooring, while a large discus buoy may be deployed in the deep ocean using a combination of chain, nylon, and buoyant polypropylene materials. Coastal buoys should be deployed in deep enough water that they are well outside of the surf zone.

A great number of applications of buoy technologies

exist, too numerous to be all inclusive, but some of the most common are listed below:

*Forecasting-* Weather forecasters require information from the oceanic and coastal areas for data input to forecast models. Deep sea and coastal buoys are required in sufficient numbers to provide data to model grid points for such applications as storm surge predictions. Without an adequate network of meteorological/oceanographic buoys, good predictions of severe coastal and tropical storms cannot be made.

*Model Validation and Data Assimilation* - Researchers involved in the development and testing of wave models require high quality data for model validation, and to determine boundary conditions. Usually directional wave and wind information is required at specific locations corresponding to model grid points and boundaries.

*Storm Surge* – Forecasters concerned with the protection of life and property want as much warning time as possible. Deep sea and coastal buoys with wind and wave sensors in the appropriate spectral bands are needed for these applications. Extreme ruggedness of buoys and components is a requirement of this application.

*Navigation & Ship Routing* – Marine pilots benefit greatly from coastal and inshore buoys providing winds, waves, and currents for navigation of large commercial vessels from offshore to dockside. Ship routing organizations require winds and waves at several locations in the deep ocean to run their models. The data for this application usually dictate the deployment of deep sea and coastal buoys equipped with wind velocity, directional wave, and current sensors.

*Search & Rescue* – Search and rescue teams require real-time information at critical locations in marine and freshwater environments to develop deployment and search strategies, and to implement those strategies. Data at specific locations may be needed to refine the search and assess possible drifting scenarios. Floating directional wave and current buoys would be needed at these specific sites.

*Military* – The forces often require environmental information at remote and little-known sites for special operations. Small, lightweight buoys reporting winds, waves, temperature, salinity, and transmitting data in real-time are required. The buoys should be deployable from aircraft, small boats, submarines, or by divers.

*Drug Interdiction & Police Work* – Real-time information on winds, waves, and currents is needed for drug interdiction missions. Anchored buoys at known critical sites, and small, easily deployed floating buoys to provide real-time data would be ideal to transit to drop sites and to interdict the perpetrators.

*Environmental Assessment* – Monitoring environmental dynamics and water quality necessitate long-term

deployments of months to years. Coastal and protected water buoys are needed in coastal, estuarine, river and lake environments. Real-time information is usually not so important as adequate temporal and spatial coverage, and choosing the key parameters.

*Marine Spill Response* – In the event of oil or other spill at sea, equipment operators, managers, and first responders such as the Coast Guard require real-time data on winds, waves, currents, and temperatures to plan and direct clean-up operations. Coastal and smaller buoys can all be brought into play to provide the necessary data.

*Recreation and sporting events* – Coastal buoys with wind velocity, directional wave, and current sensors reporting in real-time can be deployed to complement existing buoy networks in events such as sail boat races, the “Iron Man” and other long-distance swimming events. During the Bermuda Races, deep ocean buoys provide data on weather, currents (including Gulf Stream eddies and rings), and enable skippers to plot their best time routes.

*Coastal & Structural Engineering* – Marine structures, such as piers, breakwaters, oil drilling platforms are designed by ocean engineers and naval architects who require climatological wave data in the design phase, and real-time data in the deployment and data acquisition phase. Wave data is needed in real-time during oil drilling platform operations to provide for crew safety, and to prevent damage to equipment. Coastal buoys reporting wind velocity, wave height, and direction, and currents can greatly enhance safety and prevention of spills. As marine mineral extraction moves steadily from the continental shelves to the continental slopes deep ocean buoys are required to provide a safety net to the engineers, technicians, and crews

*Fishing & Bio-Assessments* – Fishing vessels are often small and/or not well equipped to deal with extreme weather events at sea or on large lakes. Deep sea and coastal buoys supporting wind velocity, directional wave, and current sensors can provide a measure of safety to the fishing fleets by providing early warning, and enabling accurate forecasts of wind and sea condition. Anchored deep sea and coastal buoys in the weather forecasting networks are most useful in this setting. These buoys should also support temperature sensors which are very useful for locating schools of fish.

*Research* – Buoy-based programs for climate prediction, tsunami detection, and undersea volcano detection require buoy data at all spatial and temporal scales. Toroidal buoys have been and are being deployed in the equatorial currents to map such features as the El Nino. Studies of the energy flux between air and sea require wind, wave, current, temperature, salinity, solar radiation, and other data. Deployment times range from months to years for climatological studies, so that power and maintenance intervals become very important considerations.

Choosing the right wave buoy for the right job requires a careful statement of requirements consistent with providing the essential data on time and at cost or below. Whether the application is for river, lake, coastal, or deep sea monitoring, a wide variety of buoys and sensors is available to get the job done, and provide data for follow up scientific and engineering analysis which may benefit future generations of mariners and all those drawn to the sea.

## 11. Acknowledgment

Special thanks are due to Mr. Ravi Sharma, a Physics Instructor at Craven Community College in New Bern, NC. His interest and detailed review enhanced the final product.

## References

- [1] Nichols, C.R., and R.G. Williams. Encyclopedia of Marine Science. New York: Facts On File, 2009.
- [2] U.S. Army Corps of Engineers. Engineering and Design: Coastal Engineering Manual. Washington, D.C. Dept. of the Army. U.S. Army Corps of Engineers, April, 2008.
- [3] AXYS Technologies, Inc. Available online. URL: <http://www.axystechnologies.com>. Accessed on February 2, 2013
- [4] Kashino, Randolph. Current State of Wave Measuring Technology from Buoys, in Ocean Waves Workshop Proceedings of New Orleans, Nov. 17, 2011. Available online. URL: <http://scholarworks.uno.edu/oceanwaves/2011/>. Accessed on February 2, 2013.
- [5] Work, Paul A., and Chathawin Srisuwan, Nearshore Applications of Wave Buoys and Alternative Technologies, in Ocean Waves Workshop Proceedings of New Orleans, Nov. 17, 2011. Available online. URL: <http://scholarworks.uno.edu/oceanwaves/2011/>. Accessed on February 2, 2013.

## Session Presentation

Available online:

<http://scholarworks.uno.edu/cgi/viewcontent.cgi?filename=2&article=1022&context=oceanwaves&type=additional>

## Session Notes

These notes are intended as a supplement to the Session I presentation. The following discussion points were captured by workshop rapporteurs:

- Waves need to be measured properly since they influence so many processes and operations near the coast and at sea. For many applications it is essential to determine the directional properties of the waves in addition to their heights and periods; yet, worldwide, there have been relatively few quantitative measurements of directional characteristics
- Buoy size and shape is an important consideration since the buoy should follow the motion of the water particles at the surface in all directions. The buoy will not be able to follow waves that are smaller than the buoys approximate diameter. Thus, the shortest wavelength that a buoy can follow is determined by the size of the buoy, while the shape of the buoy determines its responsiveness to vertical wave motion.
- Calibrating a wave buoy to specific sea states is not practical. Wave buoys are calibrated by most manufacturers using a calibration fixture that validates the buoys' wave measurements, e.g., accelerations, heave, pitch, roll, and direction. System data such as buoy orientation and GPS position are also recorded and checked. If there are significant anomalies in any of the output, buoys should be returned to the manufacturer for more exhaustive inspection and calibration. Complementary sensors such as thermistors, anemometers, and current meters also need to be checked in the laboratory or at a calibration facility. The uses of intercomparison tests (e.g., measurements against wave staffs and pressure arrays) in wave tanks, towing basins, and at an actual deployment location should be encouraged, as they increase the confidence in the data.
- Buoys and sensors need to be carefully chosen and configured for the specific environment. Environmental factors to consider include water depths and norms, means, and extremes for parameters such as wind speeds, wave heights, current profile (surface to bottom) and water temperatures.
- Prior to deployments, individual sensors should be calibrated and operationally checked. Wave buoys should then be calibrated with individual sensors attached. If at all possible, system resonances and frequency responses should be established.
- An important parameter that should be computed and provided to wave buoy users is wave steepness. The National Data Buoy Center does provide estimates of wave steepness based on the relationship between significant wave height and dominant wave period. Since wave measurements cannot be customized for each vessel's safety, the prudent mariner should know the physical limits of their vessel with respect to wind speed, wave height, and wave steepness. Pitch poling and capsizing becomes a real threat when wave steepness becomes severe. Steeper waves also contribute to beach erosion while less steep waves contribute to accretion. Wave steepness is especially important to mariners traversing fetch-limited bodies of water such as Lake Pontchartrain and especially the Great Lakes.

- Satellite radar altimeters are used to map significant wave heights while other remote sensors to include Synthetic Aperture Radar and weather radar have been used to map the sea surface. Issues with temporal and spatial resolution (e.g., some waves may be missed by radars) indicate the continued need for wave buoys. In addition, a fixed reference station such as a moored wave buoy station is needed to validate the satellite altimeter derived significant wave heights. Satellite altimetry observations are assimilated by global ocean circulation, sea state and coupled numerical models, and are used to support a variety of forecasting applications.
- Satellite or airborne photographs can be used to measure wavelengths, but wave heights are much more difficult to determine from cameras, except by rather complex procedures such as stereo photography, or Fourier transformation of the image density. Some investigators have estimated wave heights based on the deformation of the edges of cloud shadows. Satellites complement the study of waves and are not anticipated to replace wave buoys. Wave buoys provide both “sea truth” and time series at specific locations.
- Buoys are generally outfitted with rechargeable lead acid batteries and solar panels which are sufficient for most simple wave monitoring stations for long term operation (6-12 months between services). Major servicing is anticipated on 4-5 year cycles for systems using rechargeable lead acid batteries and 12-18 month cycles for systems using non-rechargeable primary batteries.
- Polar latitudes with reduced temperatures and lack of sunlight limits the power output of buoy power system, which are based on conventional silicon-based photovoltaic cells and sealed lead-acid batteries. However, wave buoys are not generally deployed during periods when the ocean is frozen.
- Alternative energy technologies that increase buoy power capabilities need to be considered. However, the uses of alternative technologies cannot adversely impact the buoys’ measurement of waves.
- NDBC is testing Wave Gliders as a weather and tsunami detection platform. Wave Gliders could potentially replace weather buoys at selected stations if they can collect data that meets NOAA/NWS requirements owing to potential operational cost benefits and logistics simplification.
- Fixed weather buoys are an incredibly valuable part of NWS basic sea state forecasting and the hurricane warning system. Both require input data from a static location to support and improve existing models. Additionally, long term records from these fixed stations form the basis for climate change analysis.
- During a maritime mishap an EPIRB (emergency position indicating radio beacon) could be deployed that is capable of transmitting wave and current information in addition to location. This information would be useful in Search and Rescue Planning or in mitigating marine spills. Wave height information would be useful in deploying the correct oil spill containment booms. Wave height information would be useful in deploying the correct oil spill containment booms. It would help in the deployment of booms to divert and channel oil slicks along desired paths. In addition, wave energy conversion could be used to help power the EPIRB, especially those used for merchant vessels transporting hazardous cargo.

These rapporteur notes do not necessarily reflect the view of all participants and speakers participating in the discussion session.



## **Session II – Development of wave modeling framework to support operations.**

Operational wave modeling frameworks include various numerical and physical approaches such as data assimilation. The mechanisms for data assimilation to improve wave forecasting are still an area of basic research, especially since wave buoy observations are sparse. This session will discuss new wave models and modeling suites that are presently being used to forecast ocean waves and to support technologies such as wave gliders. Participants will describe how wave models assimilate measurements from wave buoys and procedures used to make consistent use of ocean observations and models. The following papers and extended abstracts discuss the use of wave models to support optimal ship tracking, glider operations, marine spill response, etc.

### **Extended Abstracts**

# Utility of Delft3D Forced With Low Grade Bathymetry

Charlie Fox<sup>1)\*</sup> and Chad Monfort<sup>1)</sup>

<sup>1)</sup>QinetiQ North America

\*Corresponding author: Charles.Fox@QinetiQ-NA.com

## 1. Introduction

Expeditionary operations require a thorough assessment of the nearshore environment, such that depths, obstructions, breaking waves, and currents can be accurately predicted for conducting safe navigation through the surf zone [1]. Significant nearshore modeling challenges can be summarized by two main points: (1) high resolution nearshore model accuracy is highly dependent on the quality of nearshore bathymetry, and (2) for most locations of interest abroad the available bathymetry is of poor quality or nonexistent. It follows, that model output forced with low-grade bathymetry will lack in its ability to fully characterize the complex nearshore environment required for expeditionary operations.

The purpose of this report is to assess the usefulness of pre-forced Delft3D-Wave (D3D) in the planning/forecast process under conditions of limited/poor bathymetry (generated principally from Digital Nautical Charts, then smoothed in the model).

A period of 6-days of surf observations along a 1-km Indonesian fringing reef were compared to the D3D model predictions “forced” along the model boundary with deep water spectral wave forecasts (Spectral Wave Bulletins). In addition, manual surf calculations were derived by employing all of the available information [2,3,4]. The straight D3D model output, visual observations, and manual forecasts are compared in Fig. 1.

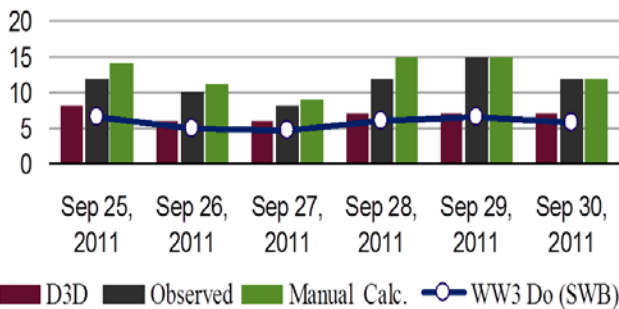

Figure 1. Comparison of results. Wave heights plotted in feet.

## 2. Conclusion

The D3D model by itself did a poor job predicting accurate surf heights, showing a very low bias (Fig. 2). However, the model correctly illuminated indispensable aspects of the surf zone critical to the planner/operational forecaster: areas of maximum and minimum wave concentration, shadowing effects and no-wave zones. Note the comparison of the model in Fig. 2 to the main surf breaks annotated in the inset image.

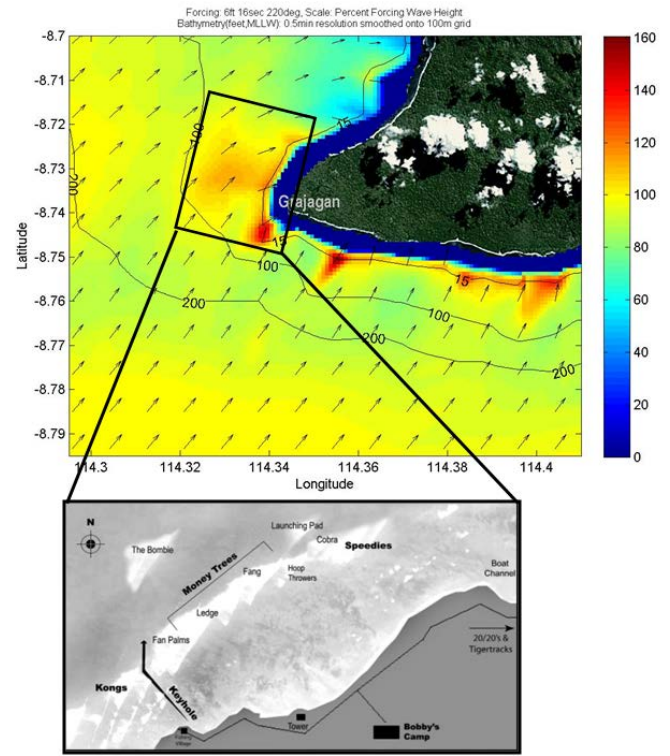

Figure 2. Pre-forced D3D model of area of interest (AOI). Inset shows location of surf breaks along the modeled reef section.

Though a straight reading of the model output was inaccurate, the predicted patterns proved extremely useful, demonstrating the model as an essential capability for the nearshore forecaster. The manual (human) forecasts plotted in Fig. 1 represents an assimilation of all available (D3D/SWB) model output, combined with nearshore nomograms, which produced values closer to the observations.

## References

- [1]Allard, R.A., G. Dawson, C. Fox, S. N. Carroll, 2010, Littoral Environmental Sensing Architecture (LESA) Report—The Current State of Sensing Capability for Naval Special Warfare METOC Support, NRL/MR/7320--10-9214, Naval Research Laboratory, Stennis Space Center, MS, 33 pp.
- [2]COMET/UCAR, “Shallow Water Waves” Training Module, Updated July 2012
- [3]NAVEDTRA 40570, Surf Forecasting, Naval Oceanographic Office, Stennis Space Center, MS, 1987
- [4]Lyons, S.W. 1994, A Simple and Practical Computerized Parametric Wave/Swell Forecast Model, NOAA Technical Memorandum NWS SR-152, Scientific Services Division, Fortworth, Texas, pp 23.

# Update of WAVCIS and the Use of Its Data for Coastal Processes

C. Li<sup>1</sup>\*, B. Gibson<sup>1</sup>, and B. Liu<sup>1</sup>

<sup>1</sup>Coastal Studies Institute, Louisiana State University, Baton Rouge, LA

\*Corresponding author: cli@lsu.edu

## 1. Introduction

WAVCIS (wave-current information system) has been going through a transition since the 2011 Ocean Waves Workshop [1, 2]. The WAVCIS data have been opened to the public for free access for up to the most recent 12 months. This policy was implemented after the summer of 2011. WAVCIS has also redesigned its web site to facilitate better data visualization and easy web site navigation (Fig. 1). Ongoing changes include improved infrastructure such as the replacement of servers. WAVCIS continues to be part of the Gulf of Mexico Coastal Ocean Observation System (GCOOS) and collaborates with the Office of Naval Research for satellite validation and Louisiana Universities Marine Consortium (LUMCON) for hypoxia research [3]. LUMCON uses WAVCIS to increase society's awareness of the environmental, economic and cultural value of Louisiana's coastal and marine environments.

Figure 1. WAVCIS data portal showing complex deltaic coast.

## 2. Conclusion

WAVCIS provides foundational data as a component of GCOOS. The information may be used by a variety of researchers, engineers, mariners, and recreational boaters. The Coastal Studies Institute is using WAVCIS data for studies of coastal currents and weather induced coastal and bay oscillations and storm surges. Our studies have revealed strong seasonal signals and large variabilities in the coastal currents. Even though the water depth is shallow at all WAVCIS site, strong vertical shears of the velocity are observed frequently. These flow patterns are associated with the wind driven flows and strong bottom friction. Bathymetry and geomorphology also plays an important role. This is demonstrated at one WAVCIS station showing flows consistent with a Louisiana Bight eddy that is often against the near shore coastal current. Thus, WAVCIS continued operation to provide real-time information (e.g., wave height, period, direction of propagation, water level, surge, near surface current speed and direction and meteorological conditions) around the entire Louisiana coast directly supports science, service, and stewardship.

## References

- [1] WAVCIS, Coastal Studies Institute, Department of Oceanography and Coastal Sciences, School of the Coast and Environment, Louisiana State University. Available online. URL: <http://wavcis.csi.lsu.edu>. Accessed on Feb 14, 2013.
- [2] Li, Chunyan, Wave-Current-Surge Information System (WavCIS), in Ocean Waves Workshop Proceedings of New Orleans, Nov. 17, 2011. Available online. URL: <http://scholarworks.uno.edu/oceanwaves/2011/>. Accessed on Feb. 14, 2013.
- [3] GCOOS, Texas A&M University, Available online. URL: <http://gcoos.org>. Accessed on Feb 14, 2013.

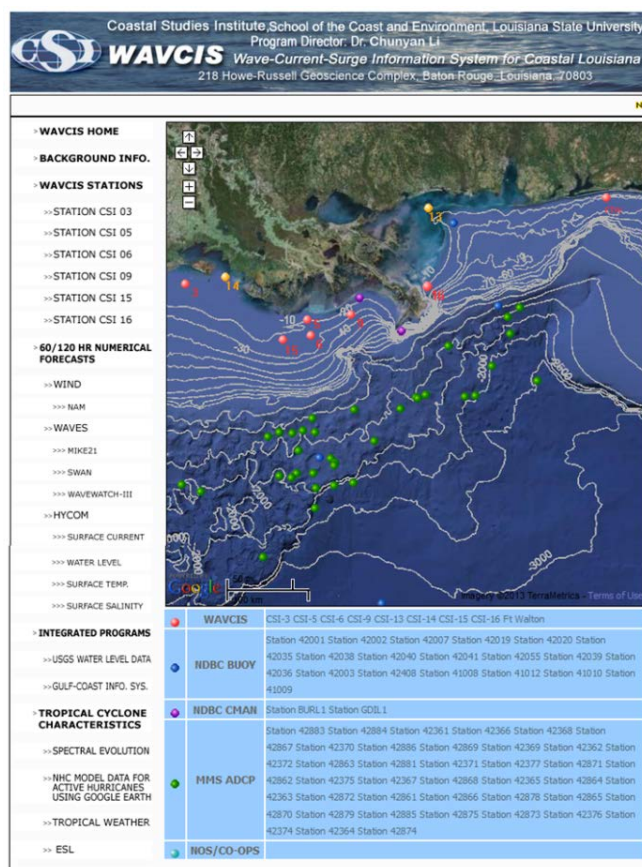

## Session Paper

None

## Session Presentation

Available online:

<http://scholarworks.uno.edu/cgi/viewcontent.cgi?article=1027&context=oceanwaves>

## Session Notes

These notes are intended as a supplement to the Session II presentation. The following discussion points were captured by workshop rapporteurs:

- Since the late 1990s, NOAA has participated in the development of the U.S. Integrated Ocean Observing System (IOOS). The NDBC Ocean Observing System of Systems includes wave buoys from other ocean observing systems. The wave buoys are important to assess the skill of wave models that are also included in the Integrated Ocean Observing Systems. In addition to observations, Ocean Observing Systems also include a modeling component.
- To be effective, especially in the generation of products or to support operations, the Federal and non-Federal ocean observing systems should maximize access to data and information products. Easier and better access to wave information improves navigation, marine spill response, search and rescue, the maintenance of seafloor cables, and the management of beaches. The wave buoy data is especially important for complex coasts such as Louisiana's delta coast.
- A variety of different models are currently being run and produce output in a variety of different data formats and conventions. Some of the key models discussed were NOAA WAVEWATCH III (WW3), Simulating WAVes Nearshore (SWAN), and Delft3D. Most of the coastal modeling systems produce data on fixed horizontal grids with fixed or stretched vertical coordinates, and deliver results in a machine-independent binary format (NetCDF, HDF or GRIB). Some observing systems are using unstructured grid data, e.g. from the Finite Volume Coastal Ocean Model or FVCOM.
- WW3 is a third generation wave model developed at NOAA/NCEP in the spirit of the WAM wave model. The governing equations simulate temporal and spatial variations of mean water depth and mean current, and wave growth and decay resulting from the implied force of the surface wind, dissipation (e.g. white capping), and the effect of the bottom friction on the water column. Since the physics of breaking waves is not included, the output is only applicable outside of the surf zone and on larger scale wave features. Both a first order and a third order accurate numerical scheme are used to solve the governing equations. Outputs from the model include: gridded fields of significant wave height (highest 1/3 of the wave heights), wave directions and wave periods associated with these wave heights and spectral information that describes the wave energy at the different wavelengths and directions.
- Attendees described several research efforts that support higher resolution computations and the use of structured and unstructured grids, including efforts to integrate Coupled Ocean/Atmosphere Mesoscale Prediction System (COAMPS), SWAN, Navy Coastal Ocean Model (NCOM), and WW3.
- SWAN is a spectral wave model developed at the Delft University of Technology, The Netherlands. It models the energy contained in waves as they travel over the ocean surface

towards the shore. In the model, waves change height, shape and direction as a result of wind, white capping, wave breaking, energy transfer between waves, and variations in the ocean floor bathymetry and currents. Initial wave conditions, including wave height, wave direction and wave period, are entered into the model, and the model computes changes to the input parameters as the waves move toward shore. Weather forecasting offices are using SWAN to produce marine forecasts. Local versions of SWAN may use input from WW3 for boundary conditions.

- Delft3D source code for FLOW, MOR, and WAVE are available online. The hydrodynamic module Delft3D-FLOW is a multidimensional hydrodynamic simulation program that calculates non-steady flow and transport phenomena resulting from tidal and meteorological forcing on a curvilinear, boundary-fitted grid. The MOR module computes sediment transport (both suspended and bed total load) and morphological changes for an arbitrary number of cohesive and non-cohesive fractions. Delft3D-WAVE computes wave propagation, wave generation by wind, non-linear wave-wave interactions and dissipation, for a given bottom topography, wind field, water level and current field in waters of deep, intermediate and finite depth. Therefore, Delft3D might be ideal for including the effects of longshore currents and rip currents.
- Navy participants were quick to point out that Delft3D can be used to provide surf prediction for areas with complicated bathymetry where the use of a one-dimensional surf model such as the Navy Standard Surf Model is inappropriate.
- Bathymetry that is necessary to run Delft3D is still difficult to obtain owing to the existence of data-sparse littoral regions.
- Surf characteristics are poorly observed and the forecasting of these characteristics remains art rather than science. One attendee stated, “the surf zone remains the black hole of modeling.”

These rapporteur notes do not necessarily reflect the view of all participants and speakers during this discussion session.

### **Session III— Recent advances and issues in wave buoy technologies.**

This session will describe the use of sensors such as accelerometers and inclinometers to measure the heave accelerations and the vertical displacements of wave buoys, which are then converted to wave parameters. Participants will discuss data processing, transmission, and display, and some analysis. The following paper and extended abstracts provide information on the latest mooring components and devices such as acoustic Doppler current profilers which complement wave buoys.

#### **Extended Abstracts**



# Circular-Slide Wave Energy Converter

H. Ming Chen <sup>1)</sup> and Donald R. DelBalzo <sup>2)</sup>\*

<sup>1)</sup> ChenDel Consulting, Albany, NY

<sup>2)</sup> Marine Information Resources Corporation, Ellicott City, MD

\*Corresponding author: delbalzo@earthlink.net

## 1. Introduction

There are two main types of wave energy converters (WEC) for small-to-moderate power applications in the deep ocean when anchoring is not desired or impractical. The first can be called a “shaking” WEC, which is similar to a rechargeable flashlight that is energized by hand shaking. The second can be called a “direct-drive” WEC, which uses a relatively stationary submerged drag-device to produce a force against surface wave motion to turn a generator. The authors have successfully designed, built, and tested both types for various applications.

The direct-drive type produces much more power per unit weight in all sea conditions than the shaking type; however, in harsh environments, it is preferable to use the shaking type, because it can be hermetically sealed to reduce environmental degradation and extend operational life. A conventional shaking WEC consists of a generator mass that hangs from springs and moves with linear motion in response to wave heaving motion. The natural frequency of a linear, mass-spring system must be close to the predominant wave frequency so that large vibration amplitudes can be achieved for effective energy harvesting. However, ocean wave frequencies are naturally low, so soft springs, with impractically large vertical deflections, are required to achieve resonance. This represents a design weakness.

We suggest a different type of shaking WEC with a mass that slides in a circular trajectory under gravity in response to wave-induced buoy pitch/roll, as illustrated in Fig. 1. This conceptual WEC includes the following major components: sliding mass, circular sliding track, connecting arm, gearbox, generator, and encoder. For protection from the harsh ocean environment, all of the components would be mounted inside a hermetically sealed box.

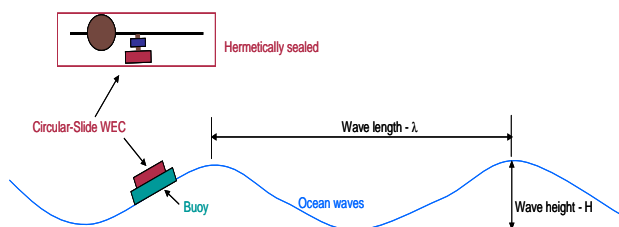

Figure 1. Circular-slide WEC utilizing buoy pitch or roll motion.

## 2. Description of Circular-Slide WEC

The sliding mass is a weight with a circular or rectangular cross-section that slides on wheels in a low-friction track with ball-bearings on rails. The connecting arm is a light structure that connects the sliding mass to the input shaft of a gearbox. The gearbox

increases the rotation speed and drives an electrical generator.

The encoder would be mounted on the gearbox input shaft. The angular displacement of the sliding mass would be measured by the encoder and used for feedback control to create an artificial torsional spring. This spring would make the sliding mass resonate, or move back and forth on the circular track when the buoy pitches or rolls due to wave motions. The angular motion of the sliding mass would be amplified by the gearbox to drive the generator and produce power. The optimal resonating angular amplitude of the mass on the track is  $\pm 90^\circ$ .

The zero reference of the feedback control points to the buoy pitch or roll axis following the wave. When the initial reference is set, the controlled axis may or may not coincide with the actual buoy axis. If they coincide, maximum power would be harvested. Therefore, during online control, the zero reference would be monitored and gradually changed to achieve maximum power.

## 3. Power Predictions

Expected power for the circular-slide WEC has been derived and shown in the equation below.

$$P = 20 \pi \eta M R H / T^3$$

where  $P$  = average power, watt

$M$  = sliding mass, kg

$R$  = circular track radius, m

$H$  = significant wave height, m

$T$  = dominant wave period, s

$\eta$  = system efficiency, assumed to be 0.75.

On average, world-wide ocean waves have a significant height of about 2m and a dominant period of about 10s. For those average conditions, our circular-slide WEC would produce average power (in watts) as listed in the following table.

Mass (kg)	Radius (m)		
	0.5	1.0	2.0
25	1	2	5
50	2	5	9
100	5	9	18

## 4. Summary

We conceptualize a new design and predict performance for a robust circular-slide, wave energy converter for use in small-to-moderate power, deep-ocean applications, such as charging batteries on weather buoys. The predicted average power is directly proportional to the sliding mass, the circular slide track radius, the wave amplitude, and inversely proportional to the wave period cubed.



**Session Papers**

(This page intentionally blank)

# Circular-Slide Wave Energy Converter

H. Ming Chen<sup>1)</sup> and Donald R. DelBalzo<sup>2)\*</sup>

<sup>1)</sup>ChenDel Consulting, Albany, NY

<sup>2)</sup>Marine Information Resources Corporation, Ellicott City, MD

\*Corresponding author: delbalzo@earthlink.net

**Abstract**—We introduce a new concept for wave energy harvesting that is robust to harsh weather conditions and relevant to long-life ocean buoy applications.

## 1. Introduction

For small-to-moderate power applications in the deep ocean where anchoring is impractical, such as charging batteries on weather buoys [1], two types of wave energy converters (WEC) are possible. The first type can be called a “shaking” WEC, which is similar to a rechargeable flashlight that is energized by hand shaking. A conventional linear shaking WEC consists of a generator mass that hangs from springs [3] and moves with linear motion in response to wave heaving motion. The natural frequency of a linear, mass-spring system must be close to the predominant wave frequency so that large vibration amplitudes can be achieved for effective energy harvesting. However, ocean wave frequencies are naturally low, so soft springs are required to achieve low frequencies, which leads to impractically large vertical deflections of the generator mass. Therefore, a conventional shaking WEC is long and bulky and the springs represent a design weakness.

The second type can be called a “direct-drive” WEC, which uses a relatively stationary submerged drag-device to produce a force against surface wave motion to turn a generator [2]. The authors have successfully designed, built, and tested a prototype deep-water direct-drive version called the Sonobuoy Wave Energy Module (SWEM) for Navy applications, as shown in Fig. 1.

This design includes a drag plate attached to the bottom of the buoy with a rod that keeps the buoy stationary. At the center of the buoy is a screw driving a generator that is fixed to the buoy. A float is attached to the top of the screw; it heaves with the waves. To extend the drag plate to deeper and calmer water, the concept was later modified as follows:

- The float was mounted on top as a fixed part of the sonobuoy cylindrical hull.
- The generator assisted with a constant-force torsion spring and power control electronics were used to charge a lithium-polymer battery, and
- A ball-screw mechanism was used to drive the generator, with a long flexible line at the end connected to a drag structure that provides a “floating anchor”.

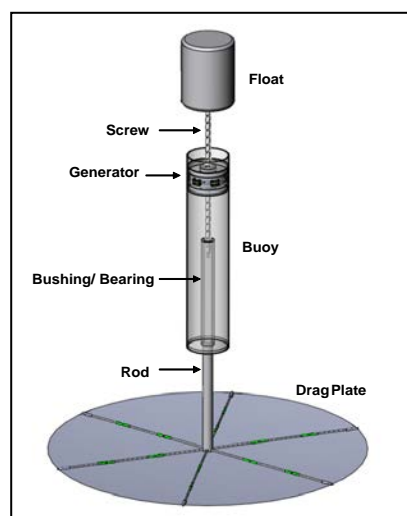

Figure 1. SWEM concept.

When a wave crest approaches, the surface float pulls the sonobuoy upward. At the same time, the drag body resists the upward motion due to its inertia and drag, pulls the ball-screw out of the buoy, spins the generator, and produces electrical power. During a wave trough the torsion spring retracts the ball-screw back into the buoy while an attached weight returns the drag body to the original depth, thereby finishing a wave cycle.

We demonstrated that the prototype system produces about 5 watts of average power in random sea waves driven by a 15-kt wind. That is to say that SWEM produces about 1 watt per foot of wave height at a wave period of 5 sec. Given the limited space available in an A-size sonobuoy, this is a remarkable achievement.

The direct-drive type can produce much more power per unit weight in all sea conditions than the shaking type; however, in harsh environments, it is preferable to use the shaking type because it can be hermetically sealed to reduce environmental degradation and to extend operational life.

We now suggest a different type of shaking WEC with a mass that slides in a circular trajectory under gravity in response to wave-induced buoy pitch/roll, as illustrated in Fig. 2. This conceptual WEC includes the following major components: sliding mass, circular sliding track, connecting arm, gearbox, generator, and encoder. For protection from the harsh ocean environment, all of the components would be mounted inside a hermetically sealed box.

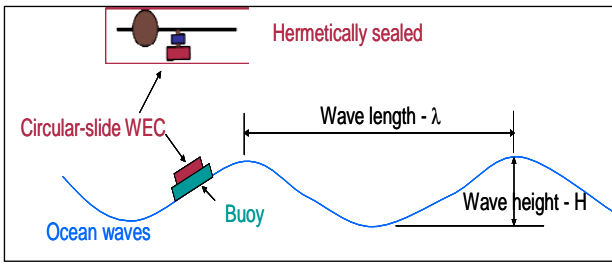

Figure 2. Circular-slide WEC utilizing buoy pitch or roll motion.

## 2. Description of Circular-Slide WEC

The concept of a circular-slide WEC (CS-WEC) is depicted in Fig. 3. The sliding mass is a weight with a circular or rectangular cross-section that slides in a low-friction track by using wheels with ball-bearings on rails. The arm is a light structure that connects the sliding mass to the input shaft of a gearbox. The gearbox increases the rotation speed and drives an electrical generator.

The encoder would be mounted on the gearbox input shaft. The angular displacement of the sliding mass would be measured by the encoder and used for feedback control to create an artificial torsional spring. This spring would make the sliding mass resonate, or move back and forth on the circular track when the buoy pitches or rolls due to wave motions. The resonating angular motion of the sliding mass would be amplified by the gearbox to drive the generator and produce power. The optimal resonating angular amplitude of the mass on the track is  $\pm 90^\circ$ .

The zero reference of the feedback control points to the buoy pitch or roll axis following the wave. When the initial reference is set, the controlled axis may or may not coincide with the actual buoy axis. If they coincide, maximum power would be harvested. Therefore, during online control, the zero reference would be monitored and gradually changed to achieve maximum power.

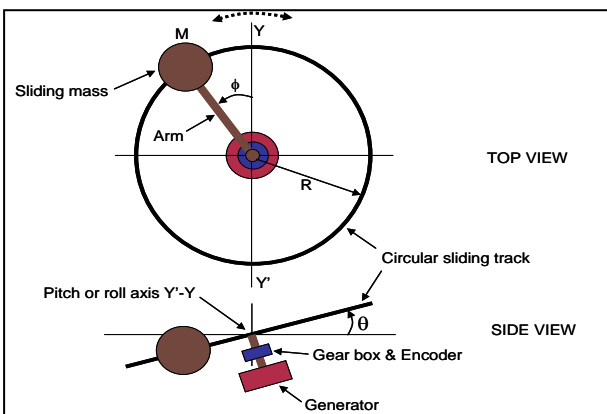

Figure 3. Major components of the circular-slide WEC.

For some buoy applications where the center portion is not available, the CS-WEC could be configured as shown in Fig. 4. The connecting arm in the original configuration is replaced by a hub with a center hole

that is supported at three points on the circular track including the one at the sliding mass. The hub is made with gear teeth, which drive a pinion connected to the generator. There is no need for a gearbox; it is replaced by the hub ring gear and pinion. Other designs of hub and drive coupling for maximizing the center hole are possible.

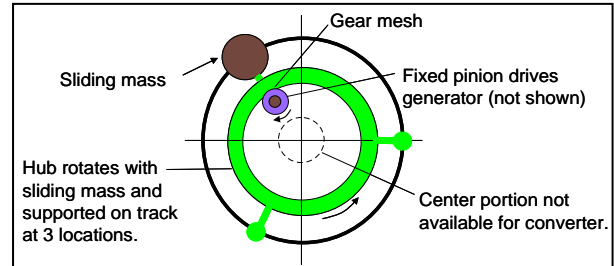

Figure 4. Hub configuration with center hole.

## 3. Advantages of Circular-Slide WEC

There is no static spring deflection problem as in the conventional shaking WEC. In fact, this concept utilizes an artificial or electromagnetic spring, which eliminates all reliability problems associated with mechanical springs. In addition, the artificial spring rate can be modified in-situ by monitoring the dominant wave period or frequency. This will keep the system in resonance all the time for maximum power.

To describe other advantages of the new concept, it is appropriate to present an old concept, *i.e.*, the Linear-Slide (LS) WEC, as shown in Fig. 5. The LS-WEC has limited stroke length ( $L$ ); the new CS-WEC has no such limit. Therefore, possible pounding damage at end stops can be avoided.

Secondly, being fixed on buoy, the LS-WEC cannot follow the changing pitch or roll axis. Another identical LS-WEC would be needed to place in a perpendicular position and compensate for the loss of power as the buoy pitch/roll axis changes. The CS-WEC can follow the changing axis by re-setting the zero reference of feedback control automatically. Therefore, the new concept is a lighter system recognizing that the major weight contribution to the system is the sliding mass.

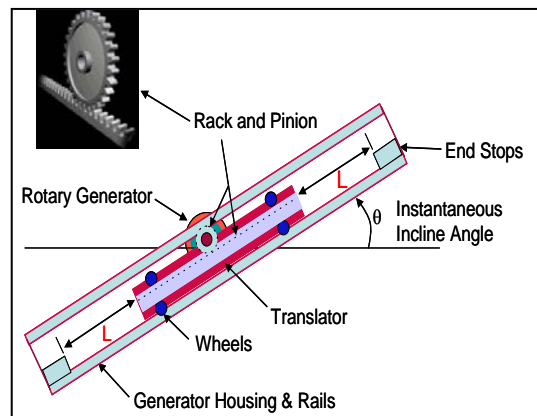

Figure 5. Previous concept - linear-slide WEC.

#### 4. Scaling Law

The relevant dynamic parameters of the CS-WEC are presented in Fig. 6.

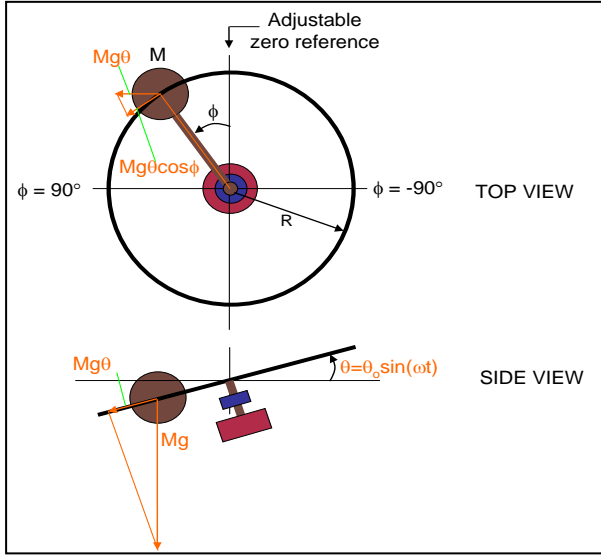

Figure 6. Relevant parameters of a circular-slide WEC.

Neglecting the polar moments of inertia of the connecting arm, generator rotor, etc., the equation of motion of a CS-WEC is:

$$MR^2 \frac{d^2\phi}{dt^2} + B \frac{d\phi}{dt} + K\phi = Mg \sin(\theta) \cos(\phi) R \quad (1)$$

where

$\phi$  = sliding mass angular displacement on track, rad  
 $t$  = time, s

$M$  = sliding mass, kg

$R$  = circular track radius, m

$B$  = damping coefficient associated with friction and power output, Nm-s/rad

$K$  = artificial torsional spring constant from feedback control, Nm/rad

$g$  = gravitational constant =  $9.81 \text{ m/s}^2$

$\theta = \theta_o \sin(\omega t)$  = instantaneous incline angle, rad

$\omega = \frac{2\pi}{T}$  = dominant wave frequency, rad/s

$T$  = dominant wave period, s

$\theta_o = \frac{H}{2\lambda} = \frac{(2\pi)^2 H}{2gT^2} \approx 2 \frac{H}{T^2}$  = buoy incline angle, rad

$H$  = significant wave height, m

$\lambda = \frac{gT^2}{2\pi}$  = deep water wave length, m

Equation (1) is nonlinear because the forcing function on the right hand side contains the term  $\cos(\phi)$ . When we average the RHS over the track angle  $\phi$ , assuming it is extended to  $\pm\pi/2$ , we get

Ocean Waves Workshop (<http://scholarworks.uno.edu/oceanwaves/>)

$$\frac{1}{\pi} \int_{-\pi/2}^{\pi/2} \cos(\phi) d\phi = \frac{2}{\pi} \quad (2)$$

Substituting (2) into (1) and assuming a small wave angle  $\theta$ , we have an approximated linear dynamic system as represented by (3).

$$MR^2 \frac{d^2\phi}{dt^2} + B \frac{d\phi}{dt} + K\phi = Mg \theta_o \sin(\omega t) \left(\frac{2}{\pi}\right) R \quad (3)$$

Let's make the artificial spring  $K$  such that the system is in resonance. Then, the inertial force cancels the spring force, and (3) becomes

$$V = \left. \frac{d\phi}{dt} \right|_{\max} = Mg \theta_o \left(\frac{2}{\pi}\right) R / B = \frac{g \theta_o \left(\frac{2}{\pi}\right)}{2\xi\omega R} = \omega \left(\frac{\pi}{2}\right) \quad (4)$$

where

$V$  = angular velocity amplitude at resonance,

$B = \xi(2\omega MR^2)$ , and

$\xi$  = damping ratio.

Using (4), the average power ( $P$ ) at resonance is:

$$P = \frac{1}{2} BV^2 \eta = \frac{1}{2} [\xi(2\omega MR^2)] \left[ \frac{g \theta_o \left(\frac{2}{\pi}\right)}{2\xi\omega R} \right]^2 \eta \quad \text{or}$$

$$P = \frac{1}{2} MgR \theta_o \omega \eta \quad (5)$$

where  $\eta$  = system efficiency, e.g., 0.75. Equation (5) can be written as:

$$P = 20 \pi \eta MRH/T^3 \quad (6)$$

The scaling law (6) indicates that the average power of a tuned circular-slider wave energy converter is directly proportional to the sliding mass ( $M$ ), the circular sliding track radius ( $R$ ), the significant wave height ( $H$ ) and inversely proportional to the wave period ( $T$ ) cubed.

On average, world-wide ocean waves have a significant height of about 2m and dominant period of about 10s. For those average conditions, our circular-slide WEC would produce average power (in watts) as listed in the following table.

	Radius (m)		
Mass (kg)	0.5	1.0	2.0
25	1	2	5
50	2	5	9
100	5	9	18

#### 5. Dynamic Simulation

The scaling law (6) is based on a simple linear concept. To confirm its validity, the original nonlinear model represented by equation (1) was programmed in Simulink. The program and the corresponding result for  $M = 100\text{kg}$  and  $R = 2\text{m}$  are presented in Fig. 7. Note that the artificial torsional spring constant,  $K$ , is set equal to  $MR^2\omega^2$  all the time, where  $MR^2$  is the approximate polar moment of inertia of the sliding parts

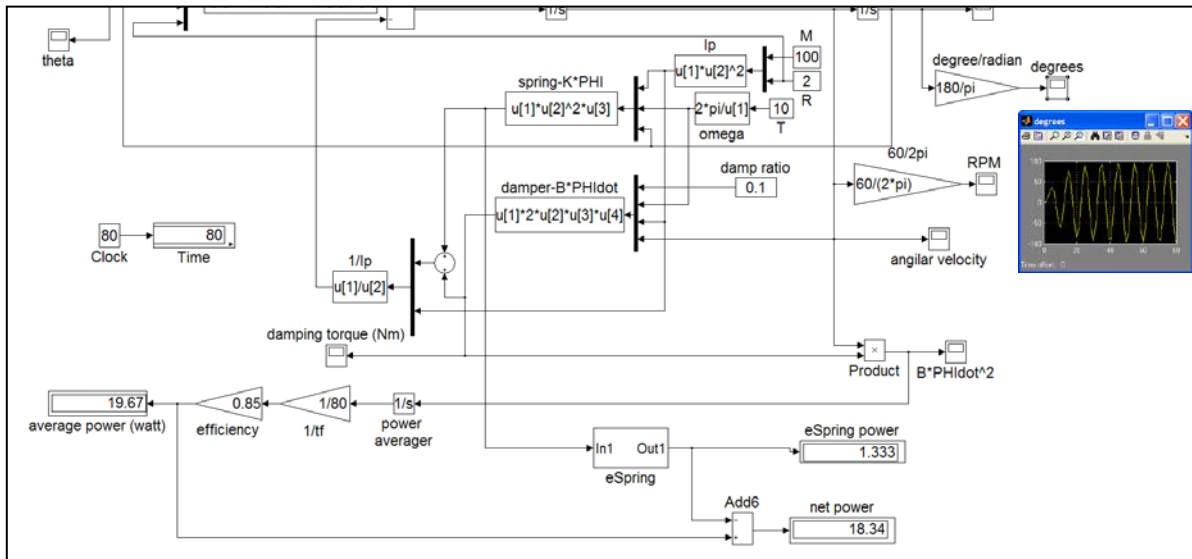

Figure 7. Dynamic simulation of a circular-slide WEC.

and  $\omega$  is the wave circular frequency. Mathematically, the control system makes a motor produce a torque ( $T_q$ ), such that:

$$T_q = -K\phi_m \quad (7)$$

where,

$$K = I_p \omega^2$$

$$I_p \approx MR^2, \text{ and}$$

$$\phi_m = \text{sliding mass angle } \phi \text{ measured by}$$

encoder.

This implies the controlled spring torque is always equal to the inertial torque, a requirement for system resonance.

The net power predicted by the Simulink program was 18.34 watts, which is close to the power predicted (18 watts) by using the scaling law.

The damping ratio  $\zeta$ , was set at 0.1 in the simulation; the sliding mass slides back and forth on the track in a semi-circle, or with  $\phi \approx \pm 90^\circ$  as indicated by the inserted scope plot in Figure 7. This implies that by changing the generator load, the system will find the maximum harvested power occurs when the mass swings back and forth of a semi-circle.

A permanent magnet brushless generator was sized to produce 0.2 HP (150 watts) at 200 rpm. The generator core had a rotor outside diameter of 100 mm, a stator outer diameter of 160 mm, and a length of 150 mm. The generator had six permanent magnets and three phases of windings. It had a torque constant of 4.3 Nm/A, and a coil resistance of 0.57 ohm per phase. We assumed that the motoring function is implemented in the generator to keep the hardware simple.

In this simulation, the mechanical efficiency was assumed to be 85%, and the electrical loss is predominantly due to the copper loss of the spring feedback control. The power consumption of the spring function was calculated to be 1.3 watt, which is much smaller than the harvested power; *i.e.*, 19.7 watts.

Ocean Waves Workshop (<http://scholarworks.uno.edu/oceanwaves/>)

## 6. Conclusions

Direct drive WECs can produce much more power per unit weight than the shaking type; however, in harsh environments, it is preferable to use the shaking type because they can be hermetically sealed to reduce environmental degradation.

We introduce a new shaking WEC concept; *i.e.*, the Circular-Slide Wave Energy Converter, which can be mounted under or on a buoy. It utilizes wave pitch and roll instead of heave. A mass slides on a low-friction circular track due to gravity when the track is tilted by waves. The sliding mass spins a generator to produce electrical power. The average harvested power is directly proportional to the mass, the track radius, and the wave height and inversely proportional to the wave period cubed.

The CS-WEC does not use mechanical springs. Instead, it measures the angular motion of a sliding mass and performs feedback control of the generator torque. The feedback creates an artificial torsion spring, which is tuned to cancel the inertial torque so that the dynamic system is always in resonance. The zero reference of the feedback control can be adjusted in-situ to respond to pitch/roll axis changes due to waves. These ensure maximum power harvesting through changing wave conditions. The power consumption of the artificial spring is proportional to the polar moment of inertia associated with the sliding mass; it can be kept low and affordable by properly designing the generator/motor.

## 7. References

- [1] NOAA, Physical Characteristics of NDBC Buoys, Stennis Space Center, Mississippi, August 1994.
- [2] DelBalzo, D.R., Sonobuoy Wave Energy Module, Final Report, QinetiQ North America, March 2012.
- [3] Cheung, J.T. & Childress, E.F. III, Ocean Wave Energy Harvesting, DARPA Phase 3 Final Report, Teledyne Scientific & Imaging, April 2008.

## Session Presentation

Available online:

<http://scholarworks.uno.edu/cgi/viewcontent.cgi?filename=0&article=1029&context=oceanwaves&type=additional>

## Session Notes

These notes are intended as a supplement to the Session III presentation. The following discussion points were captured by workshop rapporteurs:

- The use of the right type of alternative energy capability and support for its implementation is based on physical characterization surveys and baseline environmental surveys to support site assessment activities.
- Local sensors and high-resolution models are needed to site renewable energy systems and to evaluate environmental effects. Such systems could be incorporated into Integrated Ocean Observing Systems.
- The audience was reminded that during the 2011 Ocean Waves Workshop, the general consensus was that efficient wave energy conversion benefits from information on wave climatologies and extreme conditions as well as real-time wave observations and forecasts. The current workshop attendees noted that some wave energy conversion systems use the Bretschneider spectrum because the peak is broader than the JONSWAP spectrum, and is therefore more conservative for predicting power extraction. On the other hand, if the wave spectrum is narrow band it is easier to exploit. Developing seas tend to have a broader spectral peak. Decaying seas have a narrower peak. While the JONSWAP Spectrum is used by many, the Bretschneider spectrum is sometimes used when the need for fully developed seas is too restrictive.
- Wave energy conversion may offer significantly more potential energy than solar.
- Solar power was reported to be adequate to keep marine batteries aboard the buoy charged until scheduled maintenance. The solar panels can provide enough power to operate some of the buoy's sensors and transmission systems even at the end of battery life.
- Small wave energy conversion technologies need to be developed further to extend the service cycle for buoys. Such technologies may be essential for mini-buoys and sonobuoys, which have short lives.
- Some existing and prototype wave energy conversion systems would seem to alter the ability of a particular wave buoy to follow the waves.
- For the presentation on the prototype Sonobuoy Wave Energy Module, the wind waves produced more energy than swell. Energy produced by the swell decreased with increasing swell period.
- Wave energy harvesting technologies could be used to directly power transmitters that relay meteorological, oceanographic, and current GPS location for Emergency Position Indicating Radio Beacons (EPIRBs) or mini-drifting data buoys. Excess power could be stored in an onboard rechargeable battery to assure uninterrupted operations even in the lowest sea state.



This technology would extend the life of the EPIRBS and could result in greater savings of lives.

- Oregon State University in partnership with the Northwest National Marine Renewable Energy Center (NNMREC) was chosen as the future site of the first utility-scale, grid-connected wave energy test site in the United States. It will be used by engineers and scientists to measure wave resources and assist in the study of wave energy output and other wave characteristics. The testing began with Industrial Research Ltd. and Power Projects Ltd., both of New Zealand (see *Sea Technology* October, 2012, page 55).

These rapporteur notes do not necessarily reflect the view of all participants and speakers during this discussion session.

## **Session IV – Accessibility of wave information for scientists, engineers, and managers.**

This section will describe a range of topics from wave buoy telemetry devices (e.g. Iridium, WiFi, Bluetooth) and Automatic Identification System to ocean databases and National Data Centers. Participants will describe how wave data are used to assess the skill of models and to create important statistics. The following paper and extended abstracts relate to data quality control and the increasing demand for reliable information on wave conditions, particularly at coastal sites, worldwide.

### **Extended Abstracts**

# Comprehensive Software Solution for the Management of Complex Oceanographic and Meta Data

Tony Ethier<sup>1)</sup> and Craig Person<sup>1)</sup>

<sup>1)</sup>AXYS Technologies Inc, Sidney, British Columbia, Canada

<sup>\*</sup>Corresponding author: tethier@axys.com

## 1. Introduction

This paper will discuss the AXYS Data Management System (DMS) software suite, plug-ins and data viewing beginning with system configuration and communication to data acquisition, storage, and the final delivery of your data.

AXYS has developed a comprehensive data management software package that allows operators to effectively manage all critical aspects of AXYS products including all Met-Ocean and Directional Wave systems in real-time using two-way communications [1].

The vertical integration of deployed system network management makes configuration management and remote diagnostics and troubleshooting more efficient, effective, and economical.

The DMS components include: DMS Service, DMS User Interface, Microsoft SQL Server Relational Database Management System (RDBMS), SmartView desktop viewing software, and the SmartWeb web-based viewing software. SmartWeb can be installed on a laptop or installed and distributed on a corporate network across different servers and user computers allowing for a flexible and scalable solution.

The DMS has features of ASCII text logging, database logging, raw communications data relaying, message broadcasting, as well as alerts that can be configured on any data parameter such as system voltage, geofence, flood warning. These as well as system inactivity alerts can be delivered via email or SMS. Geofencing uses radio frequency identification to define virtual geographical boundaries.

What sets the DMS apart is the integration with the Watchman500 and the ability to automatically request data from the datalogger, schedule and send configuration changes, update firmware, and pipeline directly to individual sensors.

These features are possible because the DMS supports standard communications: TCP Server; TCP Client; Email (POP3, SMTP, IMAP); Serial; Modem Dialup; FTP; as well as custom interfaces direct to Inmarsat M2M, Inmarsat IsatData Pro, and GOES. These communications make it possible to support telemetry options like: VHF/UHF Radios, CDMA Modems, GPRS Modems, Inmarsat C, Iridium, Inmarsat M2M, Inmarsat IsatData Pro, Wi-Fi, Bluetooth, GOES, and GlobalStar.

The DMS Service was designed to run unattended as a self-healing Windows Service allowing users to log on and log off a computer without interrupting its operation or to be installed on a server in a data center. The DMS User Interface can be run on a separate computer Ocean Waves Workshop (<http://scholarworks.uno.edu/oceanwaves/>)

allowing interaction with the DMS Service over a LAN or VPN by multiple users.

The desktop viewing software SmartView allows users to query data, produce graphs, and check configuration and the web based software SmartWeb does the same and was developed supporting Javascript REST operations allowing for further customization.

The DMS supports the development of custom plugins to receive and decode data directly from sensors or to provide advanced functionality. AIS, SMS, Vindicator, and TRIAXYS plugins have already been developed further advancing the capabilities of the DMS. A schematic is provided in Fig. 1.

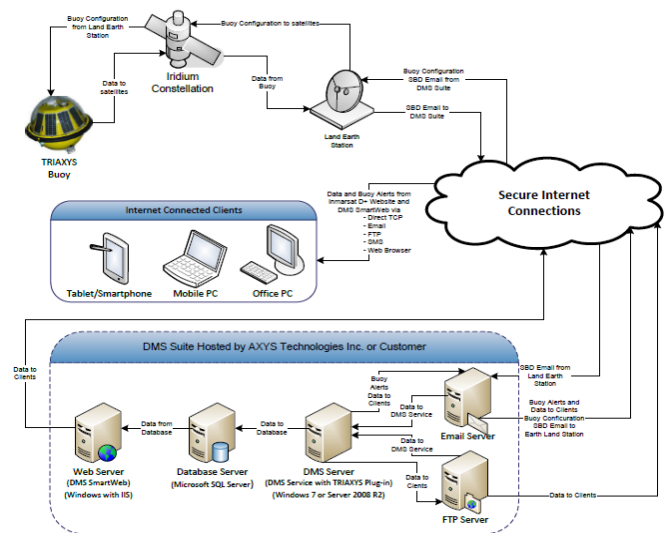

Figure 1. Example of a Typical Data Schematic for an AXYS System

Current and future development involves enhancing the mobile and web interaction with the systems through the DMS Service.

## 2. Conclusion

Operational systems such as SmartBay are applying these technologies [2]. Users of complex Met-Ocean systems need software applications to operate their remotely deployed systems, and manage large databases from collected transmitted information- DMS is one such tool.

## References

[1] AXYS Technologies Incorporated. Available online. URL: <http://www.axystechnologies.com/>. Accessed on January 24, 2013.

[2] SmartBay. Available online. URL: <http://www.smartbay.ca/>. Accessed on January 24, 2013.

**Session Paper**

(This page intentionally blank)

# Comprehensive Software Solution for the Management of Complex Oceanographic and Meta Data

Tony Ethier<sup>1)</sup> and Craig Person<sup>1)</sup>

<sup>1)</sup> AXYS Technologies Inc, Sidney, British Columbia, Canada

\*Corresponding author: tethier@axys.com

## Abstract

The AXYS Data Management System (DMS) [1] software is designed to facilitate WatchMan500™ station configuration and the control of data collection and processing for a WatchMan500™ Network Solution. The DMS is simple enough to be used with a single WatchMan500 station yet robust and scalable enough to interface with many WatchMan500 stations simultaneously. The vertical integration of deployed system network management makes configuration management remote diagnostics and troubleshooting more efficient, effective, and economical.

The DMS data collection and processing features are managed via the DMS Service application. The DMS Service is a Windows service that controls: communications (telemetry), data collection, data processing into a Database Management System (Microsoft SQL Server) and/or ASCII text files and data dissemination to other systems. The DMS is a comprehensive data management software package that allows operators to effectively manage all critical aspects of AXYS products including all Met-Ocean and Directional Wave systems utilizing real-time two-way communications.

## 1. Introduction

The operation of a remote data acquisition system (e.g. Wave Buoy) with real time telemetry, be it one station or an entire network, will rely on the dependable operation of a supervisory data management system. Key features of such a system require self-healing capabilities and the ability to avoid being accidentally terminated, along with a host of operational features for data IO, data management and data display.

The DMS is software used to communicate with one or more WatchMan500 modules. The DMS enables clients to manage:

- **What** their station network configuration looks like;
- **How** “Station-to-DMS” or “DMS-to-DMS” communication occurs;
- **What** data is being communicated;
- **How** the data being communicated gets stored; and
- **Facilitate** uploading of new Firmware to remote WatchMan 500 systems (advanced feature) via high bandwidth two-way telemetry.

Furthermore, the DMS supports various forms of telemetry to the stations and different modes on how communication is initiated. From the instant you add and configure the first station to the DMS, messages can be sent back and forth from the DMS to the station.

Once the DMS has been configured, it requires minimal user interaction and monitoring as it is designed to recover from any unexpected system/software errors. The DMS Service was designed to run unattended as a self-healing Windows Service which allows users to log on and log off a computer without interrupting its operation or to be installed on a server in a data center. The DMS User Interface can be run on a separate computer allowing interaction with the DMS Service over a LAN or VPN by multiple users. The DMS data collection and processing features are managed via the DMS Service application.

The DMS supports the development of custom plugins to receive and decode data directly from sensors or to provide advanced functionality. As an example, AIS, SMS, Vindicator, and TRIAXYS™ plugins have already been developed to further advance the capabilities of the DMS.

## 2. DMS System Requirements and Components

The DMS software will operate on any PC or Server operating Windows OS  $\geq$  XP or Windows Server  $\geq$  2003, with a 2GHz dual core CPU, >2GB RAM and hard drive capacity >100GB; this by today's standards is an entry level machine. Other required elements of the hardware will be an Ethernet port and serial IO if the system deployed requires this for interfacing.

The DMS components include: DMS Service, DMS User Interface, Microsoft SQL Server Relational Database Management System (RDBMS), SmartView desktop viewing software, and the SmartWeb web-based viewing software. SmartWeb can be installed on a laptop or installed and distributed on a corporate network across different servers and user computers allowing for a flexible and scalable solution.

The **DMS Service** is a Windows service that controls: communications (telemetry), data collection, data processing into a Database Management System (Microsoft SQL Server) and/or ASCII text files and data dissemination to other systems. The benefit of running as Windows service is the freedom for the user not to be logged in to the computer which is running the DMS.

On installation of the DMS application, a public domain **Microsoft SQL Server Relational Database Management System (RDBMS)** is installed on the host PC or Server. This is fully functional, but has a limitation in the number of stations/data that can be accepted.

The **DMS User Interface** presents information and

collects user inputs via a series of dialog boxes. Most of these dialog boxes contain common components to provide you with consistent and logical navigation throughout the entire user interface. Most dialog boxes displayed in the DMS user interface perform validation on the data you enter into the input controls. The validation is completed before the data is saved to the database to prevent errors from entering the system. Once the basic system information has been input, the client will be viewing the DMS Main Window as shown in Fig. 1.

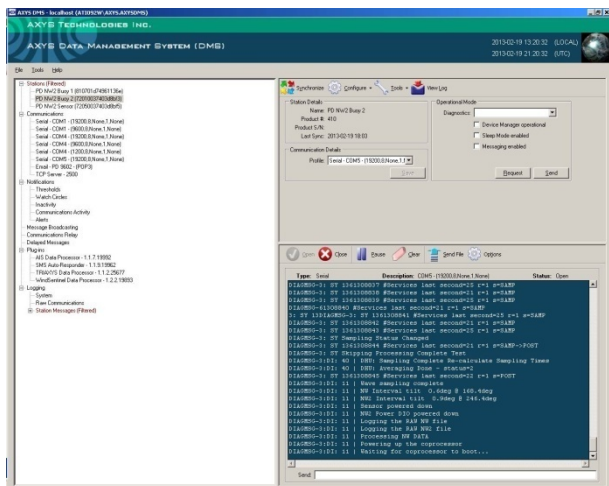

Figure 1. DMS Main Window.

The DMS main window consists of three panels. The panel to the left will be referred to as the **Tree View**. It is used to navigate the major entities in of the DMS. The contents of the *Stations* and *Communications* nodes of the tree view can be filtered by right-clicking on the desired node and entering a filter string in the pop-up box. The filtered node will be displayed in red and suffixed with the text (Filtered). The top right panel will be referred to as the **Data Panel**. It displays details of the item selected in the tree view. The bottom right panel will be referred to as the **Terminal Panel**. It displays a terminal window used to view and send data from the various communications profiles. At the top right of the main window you will also find the current date and time in both local and Coordinated Universal Time (UTC) base on your computers regional settings.

The DMS user interface can be connected to a DMS Service running on any computer within the same Local Area Network (LAN) or connect to a DMS Service running on a different computer than the user interface, Select *File Connect to Service* from the menus in the DMS main window. You will be prompted to enter the host name or IP address for the computer the DMS Service is running on. The DMS Service can handle multiple connections from different DMS user interfaces.

Before any data can be sent or received one or more communications profiles must be set up in the SQL database. Communications profiles define how the

DMS will interface with the telemetry installed on your stations.

The Communications Profiles panel contains the following items:

- *Communications Profiles* – a list of available communications profiles including type, description and current status;
- *Add* – displays a menu of items to initiate the creation of a new profile in the database:
  - *Add Serial* – *Add Dialup* – *Add Email* – *Add TCP Client* – *Add TCP Server* – *Edit* (modify an existing profile) – *Delete* – *Clone* (duplication of an existing profile);

Each of these options will have a pop-up window with configuration items specific for the telemetry connection. Each communications profile has an associated Terminal Panel. A Terminal Panel displays all data received from the underlying connection and allows data to be sent out via the underlying connection as shown in Fig. 2.

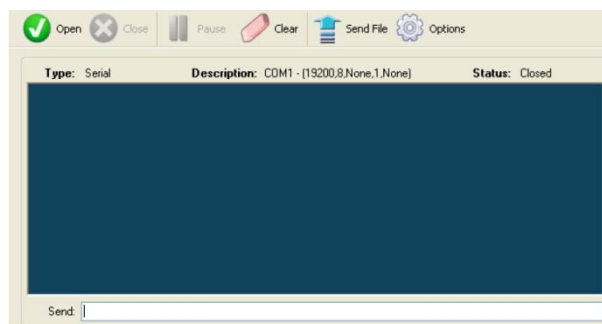

Figure 2. DMS User Interface-Terminal Panel.

The DMS supports standard communications: TCP Server; TCP Client,;Email (POP3,SMTP,IMAP); Serial; Modem Dialup;FTP; as well as custom interfaces direct to InmarsatM2M, Inmarsat IsatDataPro, and GOES. These communications make it possible to support telemetry options like: VHF/UHF Radios, CDMA Modems, GPRS Modems, Inmarsat C, Iridium, Inmarsat M2M, Inmarsat IsatDataPro, Wi-Fi, Bluetooth, GOES, and GlobalStar.

The DMS is capable of ASCII text logging, database logging, raw communications data relaying, message broadcasting.

The station(s) must be uniquely identified in the database before the DMS can be used to manage a station(s). The popup dialogue box in Fig. 3 shows the required elements to be entered for each system; many of these are automatically populated when synchronizing with a new WatchMan500 station.

With all AXYS products, the *License Serial Number* is the silicon serial number of the primary WatchMan500 node of any station. The registered *License Key* signals the DMS that the end user is authorized to manage the

station. Each station in your network will have a unique license key.

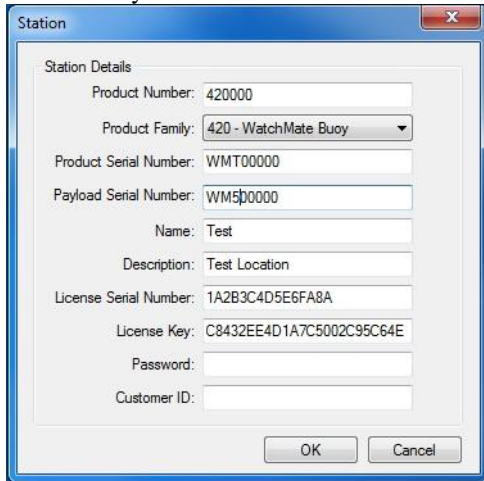

Figure 3. WatchMan500 Station Identification.

Each station must be synchronized with the DMS before any station data messages can be decoded by the DMS. The synchronization process requires a relatively large amount of data to be exchanged and stored in the database. This can be done in a number of ways; direct connect to the station, via two way telemetry to the station, on a secondary service PC which then imports the synchronization file.

### 2.1 DMS Station Configuration and Action Scripts

The WatchMan500 **Station Configuration** features are managed via the DMS User Interface. This application gives users complete control over the operation of a WatchMan500 station including: device handler (sensor) configuration, system sampling regime, data message formats and contents, onboard data logging and system diagnostics.

Before a station can collect data from its various sensors, it has to be configured to accept the specific inputs for each individual sensor. This is accomplished by installing device handlers included in the stations firmware and assigning (mapping) specific hardware, such as an A/D Channel Input or a Serial RS232 IO, to the installed device handlers. A device handler is a specific piece of the station's firmware that handles interfacing with a particular sensor. Each device handler requires a unique set of hardware that defines how and where the sensor is connected to the station.

The DMS interface has advanced capabilities to configure the remote WatchMan500 stations down to primary node port level defining the various sensor inputs and signal characteristics using what is called a "Device Handler". There are a host of predefined Device Handlers for commonly used sensors, devices and math operands available as part of the DMS/WatchMan500 device library. Options are available to interface to sensors of which defined Device Handler's are not available using either the Generic Serial or Analog Ocean Waves Workshop (<http://scholarworks.uno.edu/oceanwaves/>)

Device Handler depending on the type of sensor or device to be interfaced. Custom Device Handlers are routinely developed for new sensors.

A supplementary configuration tool is the use of **Action Scripts** which are commands that cause the WatchMan500 to perform one or more tasks. Action Scripts to respond to certain conditional events with a configured set of instructions. For example, The GPS device handler can trigger an Action Script if the station moves out of a specified watch circle radius by transmitting position more frequently. Others might deal with system power and go into a power conservation mode if certain threshold voltages are exceeded.

### 2.2 DMS Station Message Builder

The DMS allows you to configure message definitions for the data messages being transmitted or logged by your station(s) using **Message Builder** dialogue panels. A message definition includes the content, formatting, frequency and internal data logging options of a specific data message. Typical message formats follow National Marine Electronics Association (NMEA) format or custom Binary messaging.

Data messages encoded in the NMEA format are comprised of a header, body and a checksum. Users have the ability to edit default message content or create custom message content through the NMEA Message Configuration dialogue of the DMS User Interface as shown in Fig. 4.

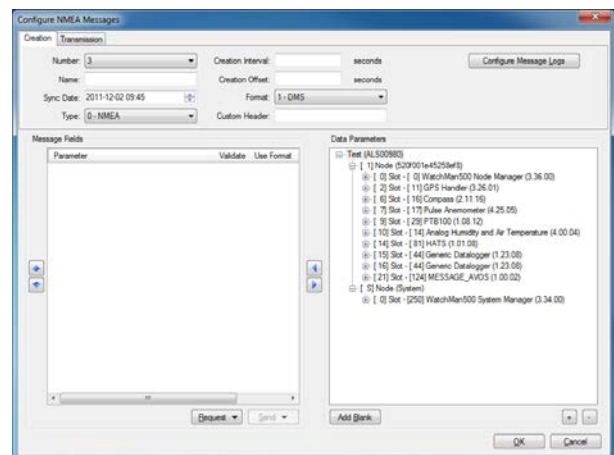

Figure 4. NMEA Message Configurator.

Binary messages can be created to minimize the amount of data sent via the selected communication profile for cost saving/bandwidth reasons. Binary messaging requires the station's firmware to contain the Binary Message Builder device handler.

### 2.3 DMS Host/Server Notifications

To aid the monitoring of the health of your station(s), the DMS provides the ability to define notification profiles.



A notification profile specifies a set of conditions used to determine if an alert should be raised warning a DMS user(s) of a station's status. The conditions are based upon the data parameters contained in the data message defined on each station. Therefore, if there is a specific parameter that needs to be monitored on a given station, then that parameter must be mapped to a data message before it can be used in a notification profile. A threshold notification allows the DMS to check a single received data parameter against one or more reference (threshold) values. The checks that can be performed are any combination of: "less than", "less than or equal to", "equal to", "greater than or equal to", "greater than", "not equal to" and "blank". The Notifications are set up using a series of pop-up dialogue panels in which the various threshold values are set for parameters such as system voltage, water intrusion or system inactivity, along with a definition of the output data message to be broadcast via the available telemetry devices (email, SMS) or initiating audible/visual local alarms.

One of the key Notifications for managing moored station(s) is to monitor the position by establishment of a geofence called a "Watch Circle". A watch circle notification allows the DMS to ensure a station does not wander off position by checking a received GPS longitude and latitude against a reference longitude, latitude and radius. The Watch Circle parameters are setup through a separate dialogue panel with similar message notification parameters to be set.

### 3. DMS Data Dissemination

The DMS provides two methods to distribute received data to other systems. The first method is *Message Broadcasting*. Message Broadcasting will only disseminate valid data messages. The second method is *Communications Relay*. Communications Relay will disseminate, in real time, all data, regardless of content.

### 4. DMS Data Display, Export and Graphing

The DMS data can be viewed using a desktop based system called SmartView[2] or a web based application called SmartWeb[3]. Examples of the SmartView home screen and graphed data are provided in Fig. 5 and 6, respectively.

The AXYS SmartView™ software designed to: display data, station configuration information and to export data from the system in common formats such as CSV, XML, or Excel. SmartView must be linked to supported AXYS DMS product databases.

The home screen of the SmartView application has a number of panels showing a tree view for station ID's and map panel showing the station locations. On selection of a station, an operator can drill down to the individual parameters of interest (data or configuration details). Once data is selected, a default range

(selectable by # of samples or date range) of data will be displayed in tabular format.

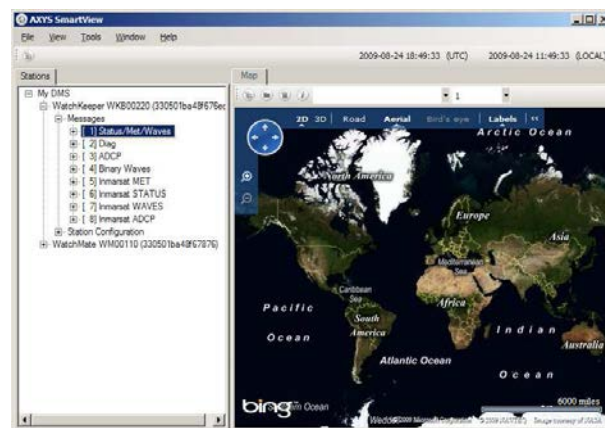

Figure 5. Screen. SmartView Home

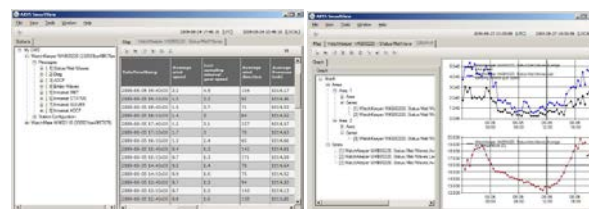

Figure 6. SmartView Tabular or Graphed Data.

The AXYS SmartWeb™ software is a web based application to: display data, station configuration information and to export data from the system in common formats such as CSV, XML, or Excel. The end user can access the data with appropriate security log-in and DMS database URL parameters.

Additional data viewing is available with the DMS plug-in framework which allows the functionality of the DMS to be enhanced and extended to support more complex data flows, message parsing and other various tasks. DMS plug-ins are components that are installed separately from the DMS.

For example, the TRIAXYS Data Processor Plug-in (TDP) allows the DMS to receive, decode, parse, store, and disseminate data from a TRIAXYS Wave Sensor with full functionality of the older non-supported WaveView™ Software. The TDP allows for a range of graphical outputs not normally supported by DMS such as Fig. 7 showing a Directional Wave Spectral.

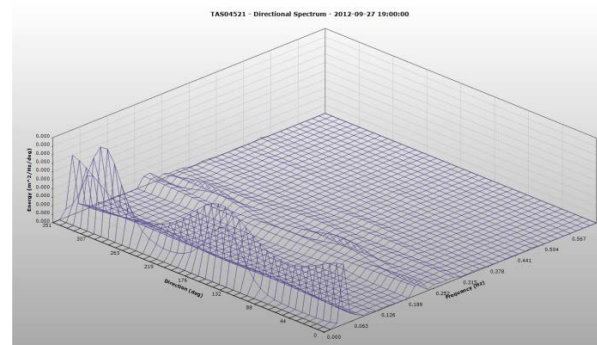

Figure 7. TDP Directional Wave Spectral Plot.



## 5. DMS System Flexibility

An integral facet of the DMS software is the ability to be configured to control a single station to an entire network with multiple routings for the ingestion of data, as well as the dissemination of tertiary data products.

In Fig. 8, a simple example of a single wave buoy is transmitting low bandwidth data via an Iridium and INMARSAT D+ satellite links. The data is received at the Land Earth Station and forwarded by email to the DMS Server. With this configuration, the DMS also has the ability to have two way communications via the Iridium and INMARSAT D+ satellite link back to the buoy to change operational parameters or query different messages.

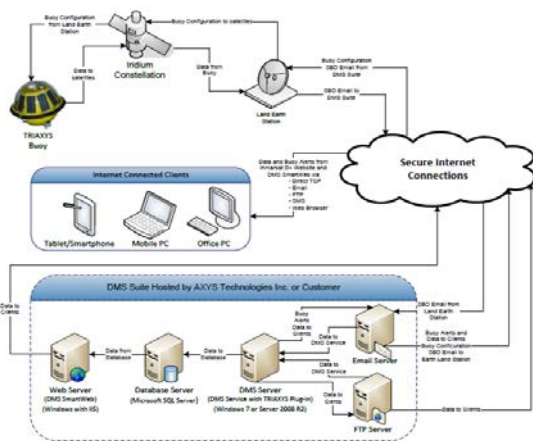

Figure 8. Example of a Typical Data Schematic for a Single Station with Single Telemetry Option.

In Fig. 9, a more complex example of multiple wave buoys transmitting low bandwidth data via an Iridium and INMARSAT D+ satellite links along with a secondary UHF data link transmitting high bandwidth data such as full directional spectral wave data. As before, the data is received at the Land Earth Station and forwarded email to the DMS Server. With this configuration, the DMS also has the ability to have two way communications via the Iridium and INMARSAT D+ satellite link back to the buoy to change operational parameters or query different messages as well as the UHF data link. In this example, there are two DMS servers receiving the data which can also be synchronized.

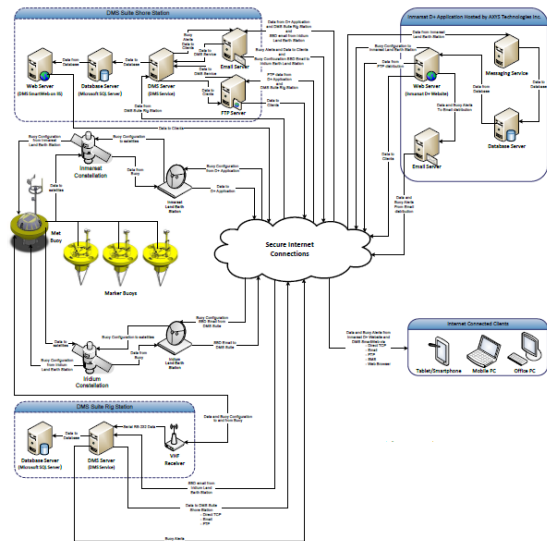

Fig. 9. Example of a Typical Data Schematic for Multiple Stations with Multiple Telemetry Options.

## 6. Conclusion

What sets the DMS apart is the integration with the WatchMan500 and the ability to automatically request data from the datalogger, schedule and send configuration changes, update firmware, and pipeline directly to individual sensors.

The desktop viewing software, SmartView, allows users to query data, produce graphs, and check configuration. The web based software, SmartWeb, does the same and was developed supporting Javascript REST operations, allowing for further customization.

Current and future development involves enhancing the mobile and web interaction with the systems through the DMS Service.

Operational systems such as SmartBay are applying these technologies[4]. Users of complex Met-Ocean systems need software applications to operate their remotely deployed systems, and manage large databases from collected transmitted information - DMS is one such tool.

## References

- [1] AXYS Data Management System™ User Manual ver 0325326Z: December 2012.
- [2] AXYS SmartView™ User Manual ver 5100900100Z: August 2009.
- [3] AXYS WebView™ User Manual ver 0375801Z: August 2007.
- [4] SmartBay. Available online. URL: <http://www.smartbay.ca/>. Accessed on January 24, 2013.

## Session Presentation

Available online:

<http://scholarworks.uno.edu/cgi/viewcontent.cgi?filename=1&article=1031&context=oceanwaves&type=additional>

## Session Notes

These notes are intended as a supplement to the Session IV presentation. The following discussion points were captured by workshop rapporteurs:

- A Data Management System (DMS) should exist to support the command and control of numerous stations. Modules would include a data acquisition system, a relational data base, and an information dissemination system.
- A viable Data Management Systems would work for many stations and multiple types of sensors, run on traditional Windows-based systems, support different communication systems, facilitate efficient data collection and processing, and provide web-based viewing.
- A DMS that allows the user to format concise messages saves money and promotes the use of essential information for smart phones.
- Being able to include bathymetry and possibly imagery-based products that show features such as wavelengths, surf zone width, and waterlines in a database supports data fusion.
- It would be important to overlay certain types of information such as wind velocity, circulation, and significant wave heights over depth.
- The online demonstration of information from SmartBay in Placentia Bay and the use of Automatic Identification System (AIS) was considered a very valuable tool to avoid collisions and most importantly to get weather and sea state information to the pilot house.
- Getting custom data transmitted from buoys should support harbor pilots who have to pin their pilot boat alongside a particular vessel, climb a ladder in order to board the vessel, and then navigate safely into the harbor. This application was mentioned as a benefit from strategically sited buoys for both SmartBay in Newfoundland, Canada and NOAA's Chesapeake Bay Interpretive Buoy System.
- Long-term inventories of measured wave data are available online from NDBC, Coastal Data Information Program, the Canada Department of Fisheries and Oceans, and from various private installations.
- In offshore waters around the world, long-term buoy wave measurement networks are still relatively few and far between. Networks with directional measurements (directional information is essential for coastal prediction) are even scarcer. Some participants indicated that the larger deep-sea buoys are being considered for removal from the inventory due to high operating costs and low budgets.
- The most highly developed wave buoy network seems to be the NOAA-NDBC buoy networks in the US, which includes links to archived information from other country's "Ocean Data Acquisition System buoys."

- Operators are using a number of database repositories for real-time and archived wave data. They include resources such as:
  - Coastal Data Information Program (CDIP) Recent Observed. Available online. URL: <http://cdip.ucsd.edu/?&nav=recent&sub=observed>
  - CDIP Historic Data. Available online. URL: <http://cdip.ucsd.edu/?&nav=historic&sub=data>
  - Canada Dept Fisheries and Oceans, Integrated Science Data Management, Available online. URL: <http://www.meds-sdmm.dfo-mpo.gc.ca/isdm-gdsi/index-eng.html>
  - Various private installations (e.g., Oil and Gas, Ports, etc that are not included in public databases).
  
- The buoy data are used primarily for (a) forecasting and optimal ship tracking, (b) validating satellite altimeter and wave model wave heights and (c) validating wave model wave periods and directions. A retired Army Corps of Engineer participant highlighted the importance of both buoy and model data to plan for coastal erosion and disaster relief.
  
- There is a need for simultaneous directional wave measurements in deep and shallow water, especially to assess the impacts from severe weather such as Hurricane SANDY.

These rapporteur notes do not necessarily reflect the view of all participants and speakers during this discussion session.

## **Biographical Sketch**

### **Theodore Robert Mettlach (1951-2011)**

Theodore ‘Ted’ Mettlach was an oceanographer and American Meteorological Society certified meteorologist who is best known for his work supporting the Fleet as a Meteorology/Oceanography Officer, enhancing the Navy Standard Surf Model, and completing research studies for the National Data Buoy Center. He was an active member of the Marine Technology Society and presented numerous technical papers during his career even teaching a short course on Ocean Wave Measurement and Analysis during the 2009 MTS/IEEE Oceans conference.

After completing enlisted service as a sonar operator and a search and rescue swimmer with the United States Navy, Mettlach attended Florida State University earning a Bachelor of Science degree in meteorology during 1979. He was commissioned and trained as a Meteorology/Oceanography Officer by the U.S. Navy. While serving on active duty, he was transferred to the Naval Postgraduate School in Monterey, California, where he completed a Master of Science degree in Meteorology and Oceanography during 1985. Following service as the staff oceanographer for Commander, Joint Task Force, Middle East in the Persian Gulf during Operations DESERT SHIELD and DESERT STORM, Lieutenant Commander Mettlach resigned his regular commission. He subsequently worked on several assignments as a naval reservist before retiring as a Commander in 2001.

Following military service, Mettlach took a faculty position with Embry-Riddle Aeronautical University and then transferred to Computer Sciences Corporation during 1991 to work on projects with the National Data Buoy Center. During 1995, Mettlach joined Neptune Sciences, Inc. and became the “go-to” person for the Navy Standard Surf Model, which is a model found in the Geophysics Fleet Mission Program Library. Noteworthy accomplishments included Mettlach’s documentation of Navy Standard Surf Model software and its subsequent validation for operational use by Marines and Sailors.

In 2005, Mettlach joined Science Applications International Corporation as a Senior Environmental Scientist, where he supported the National Data Buoy Center as a Chief Scientist. His efforts crossed many technology areas from buoy design and data quality control to conducting studies on detecting tsunamis and understanding climate change. In his capacity as a scientist with the NDBC, Mettlach made significant contributions to development of ocean observing systems.

Theodore R. Mettlach was a prolific writer and published more than 50 articles; many are frequently cited in scientific papers.

#### **Theodore Mettlach Scholarship Fund**

---

**The Ocean Waves Workshop is dedicated to the accomplishments of Mr. Theodore Robert Mettlach. If interested in donating to the Theodore Mettlach Scholarship Fund, please make your gift payable to the University of New Orleans Foundation. The address is: UNO Foundation, 2021 Lakeshore Drive, Suite 420, New Orleans, LA 70122. If you have any questions, please feel free to contact the Foundation at telephone 504-280-2800.**